



19HFL3331D/10

22HFL3331D/10

26HFL3331D/10

22HFL4371D/10

26HFL4371D/10

32HFL4351D/10

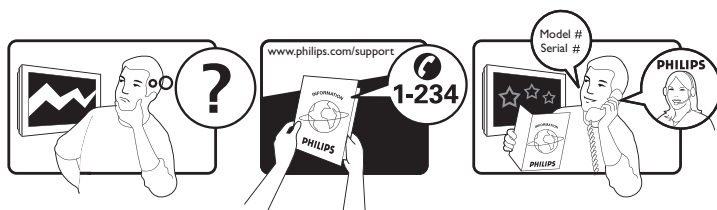

Österreich	0810 000205	€0.07 pro Minute
België/Belgique	078250145	€0.06 Per minuut/Par minute
България	+3592 489 99 96	Местен разговор
Hrvatska	01 6403 776	Lokalni poziv
Česká republika	800142840	Bezplatný hovor
Danmark	3525 8759	Lokalni opkald
Estonia	6008600	local
Suomi	09 2311 3415	paikallispuhelu
France	0821 611655	€0.09 Par minute
Deutschland	01803 386 852	€0.09 pro Minute
Ελλάδα	0 0800 3122 1280	Κλήση χωρίς χρέωση
Magyarország	0680018189	Ingyenes hívás
Ireland	North 0800 055 6882 South 1800-PHILIPS 7445477	free
Italia	840320086	€0.08 Al minuto
Қазақстан	+7 727 250 66 17	local
Latvia	52737691	local
Lithuania	67228896	local
Luxemburg/Luxembourg	40 6661 5644	Ortsgespräch/Appel local
Nederland	0900 8407	€0.10 Per minuut
Norge	2270 8111	Lokalsamtale
Polska	(022) 3491504	połączenie lokalne
Portugal	800 780 903	Chamada local
România	021-203-2060	Apel local
Россия	Moscow (495) 961-1111 Outside Moscow 8-800-200-0880	Местный звонок
Србија	+381 114 440 841	Lokalni poziv
Slovensko	0800 004537	Bezplatný hovor
Slovenija	01 280 95 22	lokalni klic
España	902 888 784	€0.10 Por minuto
Sverige	08 5792 9100	Lokalsamtal
Suisse/Schweiz/Svizzera	0844 800 544	Appel local/Ortsgespräch/Chiamata locale
Türkiye	0800 261 3302	Şehirçi arama
United Kingdom	0845-6010354	local
Україна	8-800-500-69-70	Місцевий виклик

This information is correct at the time of press. For updated information, see www.philips.com/support.

Contents

1	Notice	2
2	Important	4
3	TV overview	6
	Side controls and indicators	6
	Guest remote control	6
4	Use your product	8
	Switch your TV on/off or to standby	8
	Switch channels	8
	Watch connected devices	9
	Adjust TV volume	9
	Use Teletext	9
5	Use more of your product	10
	Access TV menus	10
	Remove devices from the home menu	10
	Change picture and sound settings	10
	Use advanced Teletext features	13
	Use the Electronic Programme Guide	14
	Use Timers	14
	Use subtitles	15
	Use the TV clock	16
	View photos and play music from a USB storage device	17
	Listen to digital radio channels	18
	Update the TV software	18
	Change TV preferences	19
	Access decoder channel	19
	Start a TV DEMO	20
	Reset the TV to factory settings	20
6	Install channels	21
	Automatically install channels	21
	Manually install channels	22
	Rename channels	23
	Reorder channels	23
	Test digital reception	23

7	Professional mode instruction	24
	Introduction	24
	Benefits of Professional mode	24
	Professional Setup Remote control (2573 optional)	24
	Activating the Professional mode setup menu	25
	Professional mode options	26
8	Connect devices	34
	Back connector for 22 inch TV	34
	Back connector for 26 inch TV and larger	36
	Side connector	37
	Connect a computer	38
	Use a Conditional Access Module	39
	Use Philips EasyLink	40
	Use a Kensington lock	40
9	Product information	41
	Supported display resolutions	41
	Multimedia	41
	Tuner/Reception/Transmission	41
	Remote control	41
	Power	41
	Supported TV mounts	41
10	Troubleshooting	42
	General TV issues	42
	TV channel issues	42
	Picture issues	42
	Sound issues	43
	HDMI connection issues	43
	Computer connection issues	43
	Contact us	43

1 Notice

2009 © Koninklijke Philips Electronics N.V. All rights reserved.

Specifications are subject to change without notice. Trademarks are the property of Koninklijke Philips Electronics N.V or their respective owners. Philips reserves the right to change products at any time without being obliged to adjust earlier supplies accordingly. The material in this manual is believed adequate for the intended use of the system. If the product, or its individual modules or procedures, are used for purposes other than those specified herein, confirmation of their validity and suitability must be obtained. Philips warrants that the material itself does not infringe any United States patents. No further warranty is expressed or implied.

Warranty

- Risk of injury, damage to TV or void of warranty! Never attempt to repair the TV yourself.
- Use the TV and accessories only as intended by the manufacturer.
- The caution sign printed on the back of the TV indicates risk of electric shock. Never remove the TV cover. Always contact Philips Customer Support for service or repairs.



Any operation expressly prohibited in this manual, or any adjustments and assembly procedures not recommended or authorised in this manual shall void the warranty.

Pixel characteristics

This LCD product has a high number of colour pixels. Although it has effective

pixels of 99.999% or more, black dots or bright points of light (red, green or blue) may appear constantly on the screen.

This is a structural property of the display (within common industry standards) and is not a malfunction.

Open source software

This television contains open source software. Philips hereby offers to deliver or make available, upon request, for a charge no more than the cost of physically performing source distribution, a complete machine-readable copy of the corresponding source code on a medium customarily used for software interchange. This offer is valid for a period of 3 years after the date of purchase of this product. To obtain the source code, write to:

GBU Customer Care Manager
Customer Care department
Philips Lighting
GBU Hospitality
Hurksestraat 2c
5652 AJ Eindhoven
The Netherlands

Compliance with EMF

Koninklijke Philips Electronics N.V. manufactures and sells many products targeted at consumers which, like any electronic apparatus, in general have the ability to emit and receive electromagnetic signals.

One of Philips' leading Business Principles is to take all necessary health and safety measures for our products, to comply with all applicable legal requirements and to stay well within the EMF standards applicable at the time of producing the products.

Philips is committed to develop, produce and market products that cause no adverse health effects. Philips confirms that if its products are handled properly for their intended use, they are safe to use according to scientific evidence available today.

Philips plays an active role in the development of international EMF and safety standards, enabling Philips to anticipate further developments in standardisation for early integration in its products.

Mains fuse (UK only)

This TV is fitted with an approved moulded plug. Should it become necessary to replace the mains fuse, this must be replaced with a fuse of the same value as indicated on the plug (example 10A).

- 1 Remove fuse cover and fuse.
- 2 The replacement fuse must comply with BS 1362 and have the ASTA approval mark. If the fuse is lost, contact your dealer in order to verify the correct type.
- 3 Refit the fuse cover.

In order to maintain conformity to the EMC directive, the mains plug on this product must not be detached from the mains cord cable.

Copyright



VESA, FDMI and the VESA Mounting Compliant logo are trademarks of the Video Electronics Standards Association.

® Kensington and Micro Saver are registered US trademarks of ACCO World Corporation with issued registrations and pending applications in other countries throughout the world.



Manufactured under licence from Dolby Laboratories. Dolby and the double-D symbol are trademarks of Dolby Laboratories.

Note

- Only applicable to TVs supporting MPEG4-HD standard

All other registered and unregistered trademarks are the property of their respective owners.

2 Important

Read and understand all instructions before you use your TV. If damage is caused by failure to follow instructions, the warranty does not apply.

Safety

- Risk of electric shock or fire!
 - Never expose the TV to rain or water. Never place liquid containers, such as vases, near the TV. If liquids are spilt on or into the TV, disconnect the TV from the power outlet immediately. Contact Philips Consumer Care to have the TV checked before use.
 - Never place the TV, remote control or batteries near naked flames or other heat sources, including direct sunlight.
To prevent the spread of fire, keep candles or other flames away from the TV, remote control and batteries at all times.
- 
- Never insert objects into the ventilation slots or other openings on the TV.
 - When the TV is swivelled ensure that no strain is exerted on the power cord. Strain on the power cord can loosen connections and cause arcing.
 - Risk of short circuit or fire!
 - Never expose the remote control or batteries to rain, water or excessive heat.
 - Avoid force coming onto power plugs. Loose power plugs can cause arcing or fire.
 - Risk of injury or damage to the TV!
 - Two people are required to lift and carry a TV that weighs more than 25 kg.
 - When stand mounting the TV, use only the supplied stand. Secure the stand to the TV tightly. Place the TV on a flat, level surface that can support the combined weight of the TV and the stand.
 - When wall mounting the TV, use only a wall mount that can support the weight of the TV. Secure the wall mount to a wall that can support the combined weight of the TV and wall mount. Koninklijke Philips Electronics N.V. bears no responsibility for improper wall mounting that result in accident, injury or damage.
 - Risk of injury to children! Follow these precautions to prevent the TV from toppling over and causing injury to children:
 - Never place the TV on a surface covered by a cloth or other material that can be pulled away.
 - Ensure that no part of the TV hangs over the edge of the surface.
 - Never place the TV on tall furniture (such as a bookcase) without anchoring both the furniture and TV to the wall or a suitable support.
 - Educate children about the dangers of climbing on furniture to reach the TV.
 - Risk of overheating! Never install the TV in a confined space. Always leave a space of at least 4 inches or 10 cm around the TV for ventilation. Ensure curtains or other objects never cover the ventilation slots on the TV.
 - Risk of damage to the TV! Before you connect the TV to the power outlet, ensure that the power voltage matches the value printed on the back of the TV. Never connect the TV to the power outlet if the voltage is different.

- Risk of injury, fire or power cord damage! Never place the TV or any objects on the power cord.
- To easily disconnect the TV power cord from the power outlet, ensure that you have full access to the power cord at all times.
- When you disconnect the power cord, always pull the plug, never the cable.
- Disconnect the TV from the power outlet and aerial before lightning storms. During lightning storms, never touch any part of the TV, power cord or aerial cable.
- Risk of hearing damage! Avoid using earphones or headphones at high volumes or for prolonged periods of time.
- If the TV is transported in temperatures below 5°C, unpack the TV and wait until the TV temperature matches room temperature before connecting the TV to the power outlet.

Screen care

- Avoid stationary images as much as possible. Stationary images are images that remain on-screen for extended periods of time. Examples include: on-screen menus, black bars and time displays. If you must use stationary images, reduce screen contrast and brightness to avoid screen damage.
- Unplug the TV before cleaning.
- Clean the TV and frame with a soft, damp cloth. Never use substances such as alcohol, chemicals or household cleaners on the TV.
- Risk of damage to the TV screen! Never touch, push, rub or strike the screen with any object.
- To avoid deformations and colour fading, wipe off water drops as soon as possible.

Disposal of your old product and batteries



Your product is designed and manufactured with high quality materials and components, which can be recycled and reused.



When this crossed-out wheeled bin symbol is attached to a product it means that the product is covered by the European Directive 2002/96/EC. Please inform yourself about the local separate collection system for electrical and electronic products.

Please act according to your local rules and do not dispose of your old products with your normal household waste.

Correct disposal of your old product helps to prevent potential negative consequences for the environment and human health.



Your product contains batteries covered by the European Directive 2006/66/EC, which cannot be disposed with normal household waste.

Please inform yourself about the local rules on separate collection of batteries because correct disposal helps to prevent negative consequences for the environmental and human health.

3 TV overview

This section gives you an overview of commonly used TV controls and functions.

Please read section 3 to 6 to set the basic consumer menu first, then follow the instructions in section 7 to set the Professional mode menu.

Side controls and indicators

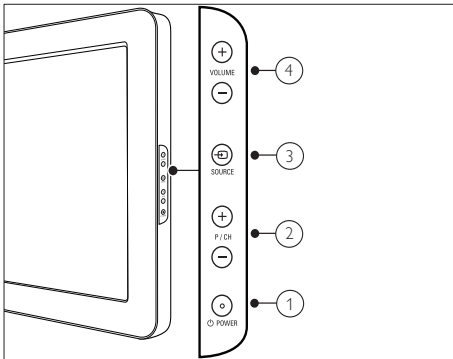

- ① **POWER:** Switches the product on or off. The product is not powered off completely unless it is physically unplugged.
- ② **P/CH +/-:** Switches to the next or previous channel.
- ③ **SOURCE:** Selects connected devices.
- ④ **VOLUME +/-:** Increases or decreases volume.

Guest remote control

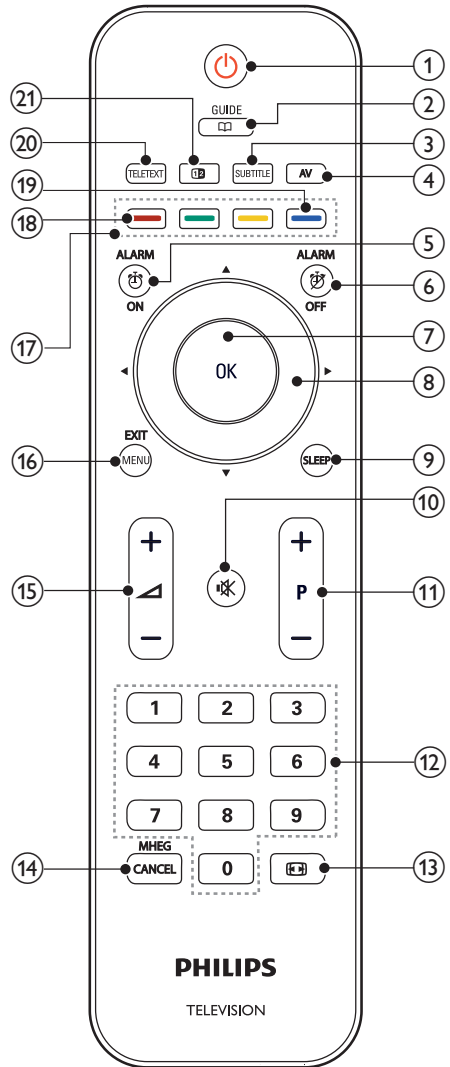

- ① **⏻ (Standby-On)**
- Switches the TV to standby if the TV is on.
 - Switches the TV on if the TV is in standby
- ② **📖 GUIDE**
Switches between channel grid and programme list.
- ③ **SUBTITLE**
Launches the subtitle menu.
- ④ **AV**
Selects connected devices.
- ⑤ **🔔 ALARM ON**
Launches [Alarm time] menu. (Only applicable in [Hospitality] mode and in some models.)
- ⑥ **🔕 ALARM OFF**
Press to disable the alarm. (Only applicable in [Hospitality] mode and in some models.)
- ⑦ **OK**
- Confirms an entry or selection.
 - Press to display the channel grid, when watching TV.
- ⑧ **▲▼◀▶ (Navigation buttons)**
Navigates through the menus.
- ⑨ **SLEEP**
Displays the sleep timer menu.
- ⑩ **🔇 (MUTE)**
Mutes or restores audio output.
- ⑪ **P+/- (Programme +/-)**
Switches to the next or previous channel. When the TV menu is on, this functions as Page Up/Down.
- ⑫ **0-9 (Numeric buttons)**
Selects a channel or setting.
- ⑬ **🖼️ (Picture format)**
Launches the picture format menu.
- ⑭ **MHEG / CANCEL**
UK only: Enables audio commentary for the visually handicapped.
- ⑮ **↔ +/- (Volume +/-)**
Increases or decreases volume.
- ⑯ **MENU / EXIT**
Toggles the main menu on or off.
- ⑰ **Colour buttons**
- Selects tasks or options.
 - When Professional mode is On, press to operate Multi remote control function. (See page 33 “Multi remote control”).
- ⑱ **Red button (DEMO)**
Toggles the demonstration menu on or off. (Only applicable in [Signage] mode, or Professional mode is set to Off).
- ⑲ **Blue button (Audio Descriptor) (For RF Digital TV only)**
UK only: Enables audio commentary for the visually handicapped.
- ⑳ **TELETEXT**
Toggles Teletext on or off.
- ㉑ **12 (OPTION)**
Accesses options relating to the current activity or selection.

 Note

- Channel grid is not available in some specific modes.

4 Use your product

This section helps you perform basic operations

Switch your TV on/off or to standby

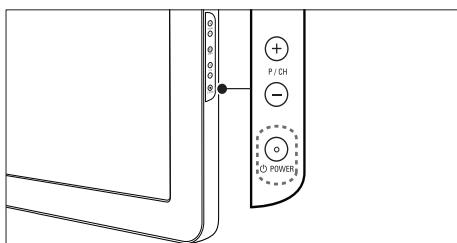

To switch on

- If the standby indicator is off, press **POWER** at the side of the TV.
- If the standby indicator is red, press **Standby-On** on the remote control.

To switch to standby

- Press **Standby-On** on the remote control.
↳ The standby indicator switches to red.

To switch off

- Press **POWER** at the side of the TV.
↳ The standby indicator switches off.

Tip

- Though your TV consumes very little power when in standby, energy continues to be consumed. When not in use for an extended period of time, disconnect the TV power cable from the power outlet.

Note

- If you cannot locate your remote control and want to switch on the TV from standby, press **P/CH +/-** or **SOURCE** at the side of the TV.

Switch channels

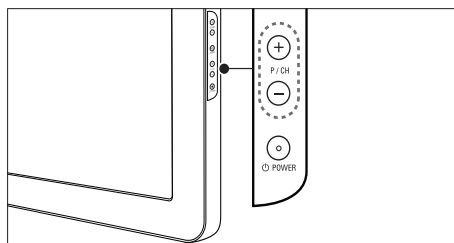
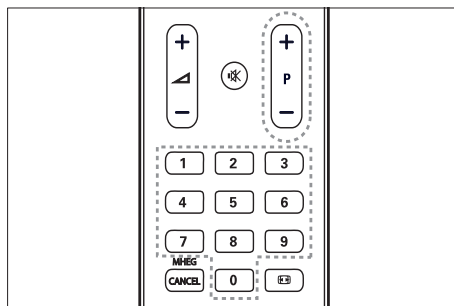

- Press **P +/-** on the remote control or **P / CH +/-** on the side of the TV.
- Enter a channel number using the **Numeric buttons**.
- Use the channel grid.

Note

- When you use a favourite list, you can only select those channels in the list.

Watch connected devices

Note

- Switch on the device before selecting it as a source on the TV.

Use the AV button

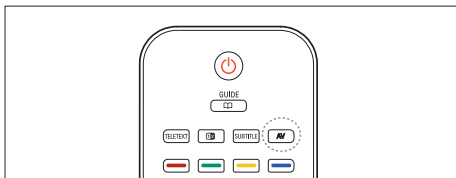

- 1 Press **AV**.
↳ The source list appears.
- 2 Press the **Navigation buttons** to select a device.
- 3 Press **OK** to confirm your choice.
↳ The TV switches to the selected device.

Adjust TV volume

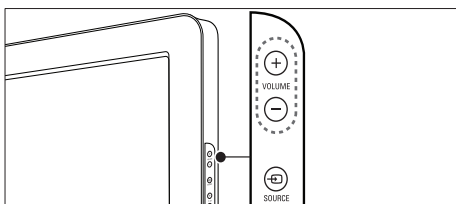
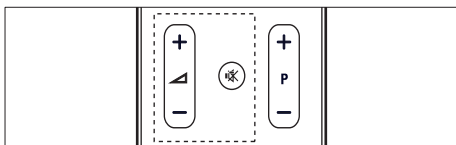

To increase or decrease volume

- Press **+**/-
- Press **VOLUME +/-** on the side of the TV.

To mute or unmute sound

- Press **MUTE** to mute the sound.
- Press **MUTE** again to restore the sound.

Use Teletext

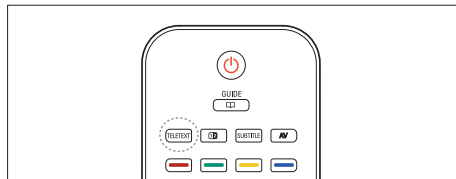

- 1 Press **TELETEXT**.
↳ The main index page appears.
- 2 Select a page as follows:
 - Press the **Numeric buttons** to enter a page number
 - Press **P +/-** or **▲▼** to view the next or previous page
 - Press the **Colour buttons** to select a colour coded item
- 3 Press **TELETEXT** to exit Teletext.

Note

- For UK users only: Some digital TV channels offer dedicated digital text services (for example, BBC1).v

5 Use more of your product

Access TV menus

Menus help you to install channels, change picture and sound settings and access other features.

- 1 Press **MENU**.
↳ The menu screen appears.

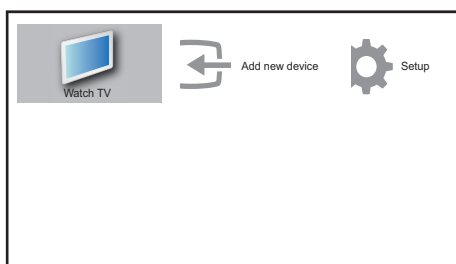

- 2 Press the **▲▼◀▶** to select and navigate through one of the following menus.
 - **[Watch TV]** Switches back to the aerial source if another source is selected.
 - **[Setup]** Accesses menus that allow you to change picture, sound and other TV settings.
 - **[Add new device]** Adds new devices to the home menu.
- 3 Press **OK** to confirm your choice.
- 4 Press **EXIT** to exit.

Tip

- After selecting **[Add new device]**, follow the on-screen instructions to select the correct device and connector.

Remove devices from the home menu

If a device is no longer connected to the TV, remove it from the home menu.

- 1 Press **MENU**
- 2 Press **▲▼◀▶** to select a device to remove.
- 3 Press **12** (**OPTIONS**).
↳ The **[Remove device]** list appears.
- 4 Press **OK** and select **[Remove]** to remove the device.
↳ The selected device is removed from the home menu.

Change picture and sound settings

Change picture and sound settings to suit your preferences. You can apply pre-defined settings or change settings manually.

Use Settings assistant

Use the Settings assistant to guide you through the best picture and sound settings.

- 1 Press **MENU**.
- 2 Press **▲▼◀▶** to select **[Setup]** > **[Picture]** > **[Settings assistant]**.
- 3 Press **OK**.
↳ The **[Settings assistant]** menu appears. Follow the on-screen instructions to choose your preferred picture settings.

Use Smart picture

Use Smart picture to apply pre-defined picture settings.

- 1 Press **MENU**.
- 2 Press **▲▼◀▶** to select **[Setup]** > **[Picture]** > **[Smart picture]**.

- 3 Press ▲▼ to select one of the following Smart picture settings.
- **[Personal]** Lists customised personal picture settings.
 - **[Vivid]** Maximises picture settings.
 - **[Standard]** Adjusts picture settings to suit most environments and types of video.
 - **[Movie]** Applies picture settings ideally suited for movie viewing.
 - **[Game]** Applies picture settings maximised for fast-moving games.
 - **[Energy saving]** Applies low-energy picture settings.
- 4 Press OK to confirm your choice.
 ↳ The selected Smart picture setting is applied.

Manually adjust Picture settings

- 1 Press MENU.
- 2 Press ▲▼◀▶ to select **[Setup]** > **[Picture]**.

Picture	Settings assist.	Action
	Smart picture	Personal
Sound	Contrast	
	Brightness	
Features	Colour	
	Hue	
Installation	Sharpness	
	Noise reduction	Off
Software update		

- 3 Press ▲▼◀▶ to select one of the following picture settings.
- **[Smart picture]** Accesses pre-defined smart picture settings.
 - **[Contrast]** Adjusts the intensity of bright areas, keeping dark areas unchanged.
 - **[Brightness]** Adjusts the intensity and details of dark areas.
 - **[Colour]** Adjusts colour saturation.
 - **[Hue]** Compensates colour variations in NTSC encoded transmissions.
 - **[Sharpness]** Adjusts the level of sharpness in image details.
 - **[Noise reduction]** Filters and reduces noise in an image.
 - **[Tint]** Adjusts the colour balance in an image.
 - **[Custom tint]** Make a customised tint setting. (Only available if **[Tint]** > **[Custom]** is selected)
 - **[Digital Crystal Clear]** Fine-tunes each pixel to match surrounding pixels. This produces a brilliant, high-definition image.
 - **[Dynamic contrast]** Automatically enhances contrast in an image. A **[Medium]** setting is recommended.
 - **[Dynamic backlight]** Adjusts the brightness of the TV backlight to match lighting conditions.
 - **[MPEG artifact reduction]** Smoothes out transitions on digital pictures. You can switch this feature on or off.
 - **[Colour enhancement]** Makes colours more vivid and improves the resolution of details in bright colours. You can switch this feature on or off.
 - **[PC mode]** Adjusts the picture when a PC is connected to the TV via HDMI or DVI.
 - **[Picture format]** Changes the picture format.
 - **[Horizontal shift]** Adjusts the picture horizontally for PC-VGA, DVI, HDMI or YPbPr.
 - **[Vertical shift]** Adjusts the picture vertically for PC-VGA, DVI, HDMI or YPbPr.

Change picture format

- 1 Press **[F4]**.
↳ A picture format bar appears.
- 2 Press **▲▼** or **[F4]** to select a picture format.
↳ The selected picture format is activated.
- 3 Press **OK** to confirm your choice.

Summary of picture formats

The following picture settings can be configured.

Note

- Depending on the format of the picture source, some picture settings are not available.

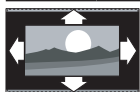

[Auto format](Not for PC mode.) Enlarges the picture automatically to best fit the screen. The subtitles remain visible.



[Super zoom](Not for HD and PC mode.) Removes the black bars on the side of 4:3 broadcasts. There is minimal distortion.



[4:3]Shows the classic 4:3 format.



[Subtitle zoom]Displays 4:3 pictures over the full area of the screen, with sub-titles visible. Part of the top of the picture is clipped off.



[Movie expand 14:9](Not for HD and PC mode.) Scales 4:3 format to 14:9.

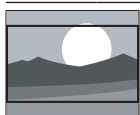

[Movie expand 16:9](Not for HD and PC mode.) Scales 4:3 format to 16:9.



[Wide screen]Stretches the classic 4:3 format to 16:9.



[Unscaled]For HD and PC mode only, and in selected models only. Allows maximum sharpness. Some distortion may be present due to the broadcaster's systems. Set your PC resolution to wide screen mode for best results.

Use Smart sound

Use Smart sound to apply pre-defined sound settings.

- 1 Press **MENU**.
- 2 Press **▲▼◀▶** to select **[Setup]** > **[Sound]** > **[Smart sound]**.
- 3 Press **▲▼** to select one of the following Smart sound settings.
 - **[Standard]** Adjusts sound settings to suit most environments and types of audio.
 - **[News]** Applies sound settings ideally suited for spoken audio, such as the news.
 - **[Movie]** Applies sound settings ideally suited for movies.
 - **[Personal]** Applies the settings that were customised in the sound menu.
- 4 Press **OK** to confirm your choice.
↳ The selected Smart sound setting is applied.

Adjust sound settings

- 1 Press **MENU**.
- 2 Press **▲▼◀▶** to select **[Setup]** > **[Sound]**.
↳ The **[Sound]** menu appears.

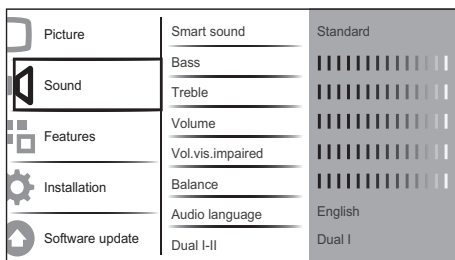

3 Press ▲▼◀▶ to select one of the following sound settings.

- **[Smart sound]** Accesses pre-defined smart sound settings.
- **[Bass]** Adjusts the bass level.
- **[Treble]** Adjusts the treble level.
- **[Volume]** Adjusts the volume.
- **[Vol.vis.impaired]** Adjusts the volume of visually impaired audio when your current channel supports visually impaired function. (Applies for UK only)

Note

- **[Vol.vis.impaired]** only appears if you select **[Setup] > [Installation] > [Language] > [Visually impaired] > [On]**.
- **[Visually impaired]** (Audio Descriptor): Sets the mix of visually impaired audio with regular audio. When available, visually impaired audio includes audio descriptions of on-screen action.

- **[Balance]** Adjusts the balance of the right and left speakers to best suit your listening position.
- **[Audio language]** Available for digital channels, when multiple languages are broadcast. Lists available audio languages.
- **[Dual I-II]** Selects between audio languages if dual sound is broadcast.
- **[Mono/Stereo]** Selects between mono or stereo if stereo is broadcast.
- **[TV speakers]** Turns TV speakers on or off.
- **[Surround]** Enables spatial sound.

- **[Headphone volume]** Adjusts headphone volume. (Only appears when Professional mode is **[Off]**)
- **[Auto volume]** Automatically reduces sudden volume changes, for example, when switching channels. When enabled, this produces a more consistent audio volume.
- **[Delta volume]** Levels out volume differences between channels or connected devices. Switch to the connected device before you change the delta volume.

Use advanced Teletext features

Access the Teletext options menu

Most of the advanced Teletext features are accessed via the Teletext options menu.

- 1 Press **TELETEXT**.
↳ The Teletext screen appears.
- 2 Press **12** (**OPTIONS**).
↳ The Teletext options menu appears.
- 3 Press **▲▼** to select one of the following options.
 - **[Freeze page]** Freezes the current page.
 - **[Dual/Full screen]** Enables and disables dual screen Teletext, which splits the current channel or source to the left of the screen, with Teletext on the right.
 - **[Reveal]** Hides or reveals hidden information on a page, such as solutions to riddles or puzzles.
 - **[Cycle subpage]** Cycles through subpages automatically if subpages are available.
 - **[Language]** Switches to a different language group to display a language correctly when that language uses a different character set.

- 4 Press **OK** to confirm your choice.
- 5 Press **TELETEXT** to exit the Teletext options menu.

Select Teletext subpages

A Teletext page can hold several subpages. Subpages are displayed on a bar next to the main page number.

- 1 Press **TELETEXT**.
↳ The Teletext screen appears.
- 2 Press **▲▼** to select a Teletext page.
- 3 Press **◀▶** to enter a subpage.

Use the Electronic Programme Guide

EPG is an on-screen guide available for digital channels. EPG allows you to:

- View a list of digital programmes being broadcast
- View upcoming programmes
- Group programmes by genre

Switch on EPG

- 1 When watching TV, press **GUIDE**.
↳ The EPG planner screen appears displaying information about the scheduled programmes.



Note

- EPG data is available only in selected countries and can take some time to load.



Tip

- Press **GUIDE** to switch between EPG and channel grid. (Channel grid will only appear in some specific modes).

Use EPG

- 1 When watching TV, press **GUIDE**.
↳ The EPG planner screen appears.
- 2 Press **MENU**.
↳ The program guide menu appears.
- 3 Press **▲▼◀▶** to select an option, and then press **OK** to confirm it.
- 4 Press **EXIT** to exit the EPG menu.

Use the EPG options menu

Use the EPG options menu to set or clear reminders, change day and access other useful EPG options.

- 1 Press **GUIDE**.
- 2 Press **12** (**OPTIONS**).
↳ The EPG menu appears.
- 3 Press **▲▼** to select one of the following options.
 - **[Show info]**
 - **[Search by genre]**
- 4 Press **OK** to enter or activate the option.
- 5 Press **EXIT** to exit the EPG menu.

Use Timers

You can set timers to switch the TV on or switch to standby at a specified time.

Automatically switch the TV to standby (Sleep timer)

Sleep timer switches the TV to standby after a pre-defined period of time.



Tip

- You can always switch off your TV earlier or reset the Sleep timer during the countdown.
- Press **SLEEP** on the Guest remote control to quick access the Sleep timer menu.

- 1 Press **MENU**.
- 2 Press **▲▼◀▶** to select **[Setup] > [Features] > [Sleep timer]**.
↳ The bar appears.
- 3 Press **◀▶** to set the sleep time.
↳ The Sleep timer can be up to 180 minutes in steps of five minutes. If set to zero minutes, the Sleep timer is switched off.
- 4 Press **OK** to activate the Sleep timer.
↳ The TV switches to standby after the pre-defined period of time.

Alarm (On timer)

You can switch the TV to a specified channel at a specified time, from standby or power-on mode.

- 1 Press **MENU**.
- 2 Press **▲▼◀▶** to select **[Setup] > [Features] > [On timer]**.
- 3 Press **OK** or **▶** to enter the **[On timer]** menu.
 - **[Activate]** Selects the frequency to **[Off]** or **[Once]** or **[Daily]**.
 - **[Time]** Sets the starting time to switch on the TV automatically.
 - **[Programme no.]** Selects the channel.
- 4 Press **EXIT** to exit.

Tip

- Select **[On timer] > [Activate] > [Off]** to disable **[On timer]**.
- Refer to page 32 "*How to set the TV alarm?*" for more details about TV alarm.

Use subtitles

You can enable subtitles for each TV channel. Subtitles are broadcast via Teletext or DVB-T digital broadcasts. With digital broadcasts, you have the additional option of selecting a preferred subtitle language.

Enable subtitles on analogue TV channels

- 1 Select an analogue TV channel.
- 2 Press **TELETEXT**.
- 3 Enter the three-digit page number of the subtitle page with the **Numeric buttons**.
- 4 Press **TELETEXT** to switch off Teletext.
- 5 Press **SUBTITLE**.
↳ The **[Subtitle mode]** menu appears.
- 6 Select **[On]** to display subtitles always or **[On during mute]** to display subtitles only when audio is muted.
- 7 Press **OK** to enable subtitles.

Note

- Repeat this procedure to enable subtitles on each analogue channel.

Tip

- Select **[Subtitle mode] > [Off]** to disable subtitles.

Enable subtitles on digital TV channels

- 1 When watching digital channels, press **SUBTITLE**.
↳ The **[Subtitle mode]** menu appears.
- 2 Select **[On]** to display subtitles always or **[On during mute]** to display subtitles only when audio is muted.
- 3 Press **OK** to enable subtitles.

Select a subtitle language on digital TV channels

Note

- When you select a subtitle language on a digital TV channel as described below, the preferred subtitle language set in the installation menu is temporarily overruled.

- 1 Press **MENU**.
- 2 Press **▲▼◀▶** to select **[Setup]** > **[Features]** > **[Subtitle language]**.
- 3 Press **OK** or **▶** to enter the list of available languages.
- 4 Press **▲▼** to select a subtitle language.
- 5 Press **OK** to enable your selection.

Tip

- You can also access **[Subtitle language]** menu while watching TV by pressing **12 (OPTIONS)** > **[Subtitle language]**.

Use the TV clock

You can display a clock on the TV screen. The clock displays the current time using time data received from your TV service operator.

Note

- Please refer to page 31 “*Clock setup*” for more details of Pro+ clock settings.

Display the TV clock

- 1 When watching TV, press **12 (OPTIONS)**
↳ The TV option menu appears.
- 2 Select **[Clock]**.
- 3 Press **OK**.

Note

- To disable the clock, repeat the above procedure.

Change the clock mode

- 1 Press **MENU**.
- 2 Press **▲▼◀▶** to select **[Setup]** > **[Installation]** > **[Clock]** > **[Auto clock]**.
- 3 Press **OK** or **▶** to enter the **[Auto clock]** menu.
- 4 Press **▲▼** to select **[Automatic]** or **[Manual]**.
- 5 Press **OK** to confirm.

Change the Time zone

- 1 Press **MENU**.
- 2 Press **▲▼◀▶** to select **[Setup]** > **[Installation]** > **[Clock]** > **[Time zone]**.
- 3 Press **▲▼** to select your Time zone.
- 4 Press **OK** to confirm.

Note

- This option is only available if you select **[Auto clock]** > **[Manual]** (In countries with clock transmission data).

Use Daylight saving

- 1 Press **MENU**.
- 2 Press **▲▼◀▶** to select **[Setup]** > **[Installation]** > **[Clock]** > **[Daylight saving]**.
- 3 Press **OK** or **▶** to enter **[Daylight saving]**.
- 4 Press **▲▼** to select **[Standard time]** or **[Daylight saving time]**.
- 5 Press **OK** to enable your selection.

Note

- This option is only available if you select **[Auto clock]** > **[Manual]**.

View photos and play music from a USB storage device

! Caution

- Philips is not responsible if the USB storage device is not supported nor is it responsible for damage or loss of data from the device.

Your TV is fitted with a USB connector that enables you to view photos or listen to music stored on a USB storage device.

- Turn on the TV.
- Connect the USB device to the USB port on the side of your TV.
 - The home menu appears.

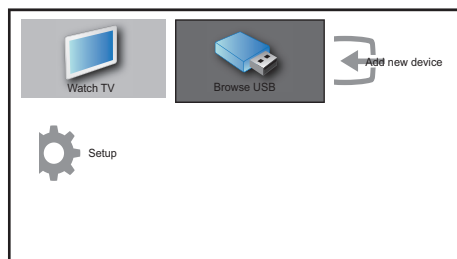

- Press **▲▼◀▶** to select **[Browse USB]**.
- Press **OK** to confirm.
 - The USB thumbnail browser appears.

* Tip

- Press **GUIDE** to switch between thumbnail and file browsing views.

View photos

- In the USB thumbnail browser, select **[Picture]** and press **▶** to enter.
- Press **GUIDE** to switch between thumbnail and file browsing views.
- Press **▲▼◀▶** to select a photo or a photo album.

- Press **OK** to view the selected photo in full screen mode.

* Tip

- When in full screen mode, press **◀▶** to move between photos.

View a slide show of your photos

- When a full screen image of a photo is displayed, press **OK**.
 - A slide show begins from the selected image.
- Press:
 - OK** to pause the slide show.
 - The **||** icon appears.
 - Press **◀▶** to go back or move forward to the next image.
 - EXIT** to stop the slide show.

Change slide show settings

- When viewing a slide show, press **123 (OPTIONS)**.
 - The slide show options menu appears.
- Press **▲▼** to select one of the following.
 - [Start/Stop slide.]** Starts or stops a slide show.
 - [Slideshow trans.]** Sets the transition from one picture to the next.
 - [Slideshow freq.]** Sets the amount of time that a picture is shown.
 - [Rotate image]** Rotates a picture.
 - [Show info]** Displays the picture name, date, size and next picture in the slide show.
- Press **OK** to confirm your setting.

≡ Note

- [Rotate image]** and **[Show info]** appear only when you press **OK** to pause the slideshow.

Listen to music

- 1 In the USB thumbnail browser view, select **[Music]** and press **▶** to enter.
- 2 Press **📖 GUIDE** to switch between thumbnail and file browsing views.
- 3 Press **▲▼◀▶** to select music or a music album.
- 4 Press **OK** to play the selected music.

Music settings

When listening to music, press **Ⓜ (OPTIONS)** to access one of the following music settings.

- **[Start/Stop play]**
- **[Repeat/Play once]**
- **[Shuffle on/off]**
- **[Show info]**
- **[TV speakers]**

Disconnect a USB storage device

Caution

- Follow this procedure to avoid damage to your USB storage device.

- 1 Press **EXIT** to exit the USB browser.
- 2 Wait for five seconds before you disconnect the USB storage device.

Listen to digital radio channels

If digital broadcasting is available, digital radio channels are installed automatically during installation.

- 1 When watching TV, press **OK** to display the channel grid.
- 2 Press **Ⓜ (OPTIONS)**.
- 3 Press **▲▼** to select **[Filter channels] > [Radio]**.
↳ The radio channel grid appears.

- 4 Press **▲▼◀▶** to select a radio channel and press **OK** to listen.

Note

- Select **[Filter channels] > [All]** to exit radio channels and view all channels.

Update the TV software

Philips continuously tries to improve its products and we recommend that you update the TV software when updates are available. Check www.philips.com/support for availability.

Check the current software version

- 1 Press **MENU**.
- 2 Press **▲▼◀▶** to select **[Setup] > [Software update] > [Current software]**.
↳ The TV displays the current software information.

Update software (digital broadcasts)

You can update the TV software via a USB device or OAD.

Update using a USB device

Connect your USB device to the USB port at the side of your TV.

- 1 If the software update screen does not appear automatically, select **[Setup] > [Software update] > [Local updates] > [USB]** to update the TV software manually.
- 2 Follow the on-screen instructions to complete the update.

Note

- The TV restarts after the software update is complete.

Update using OAD (On the Air software Download)

If Professional mode is **[On]**, your TV automatically receives software updates in semi-standby mode without notice on screen. The TV restarts after the software update is complete.

Change TV preferences

- 1 Press **MENU**.
- 2 Press **▲▼◀▶** to select **[Setup]** > **[Installation]** > **[Preferences]**.
- 3 Press **OK** or **▶** to enter **[Preferences]**.
 - **[Location]** Optimises TV settings for your location - home or shop.



Note

If **[Shop]** mode is selected:

- The **[Smart picture]** setting will be switched to **[Vivid]** automatically to display the brightest backlight on screen.
- E-sticker is applicable to display the TV selling features on screen.
 - **[Volume bar]** Displays the volume bar when adjusting the volume.
 - **[Channel info.]** Displays information about the TV channel every time you switch channels. Select **[Full]** to view channel information or **[Off]** to turn off the channel information.
 - **[EasyLink]** Enables one-touch play and one-touch standby between EasyLink compliant devices.
 - **[E-sticker]** For shop mode only. Sets the location of the e-sticker.

Access decoder channel

You can map channels provided through a decoder or descrambler to your TV channel selection. In this way, you can select these channels by using the RC of your TV. The decoder or a descrambler must be connected to EXT1 (SCART).

Set decoder channel

Map channels from a decoder or descrambler

- 1 Press **MENU**.
- 2 Press **▲▼◀▶** to select **[Setup]** > **[Installation]** > **[Preferences]** > **[Decoder]**.
- 3 Press **OK** or **▶** to enter **[Decoder]** menu.
- 4 Press **▲▼** to select **[Channel]** and press **OK** or **▶** to enter.
 - ↳ A list of analogue channels appears on the screen.
- 5 Press **▲▼** to select one channel to map to the decoder/descrambler channel and press **OK** to confirm.
- 6 Select **[Status]** and press **OK** or **▶** to enter.
- 7 Press **▲▼** to select **[EXT 1]** (SCART) the connector used by the decoder/descrambler.
- 8 Press **OK**.
- 9 Press **EXIT** to exit.

Start a TV DEMO



Note

Before starting DEMO, make sure to activate one of the following setting for TV DEMO to take effect:

1. [PBS settings] > [PBS mode] > [Off].
2. [PBS settings] > [Applications] > [Signage].

- 1 Press **Red button (DEMO)** on the remote control.
- 2 Press **▲▼** to select a demo and press **OK** to view it.
- 3 Press **Red button (DEMO)** to exit.

Reset the TV to factory settings

You can restore the default picture and sound settings of your TV. Channel installation settings remain the same.

- 1 Press **MENU**.
- 2 Press **▲▼◀▶** to select **[Setup]** > **[Installation]** > **[Factory settings]**.
- 3 Press **OK** or **▶** to enter the **[Factory settings]** menu.
↳ A factory setting message appears.
- 4 Select **[Reset]** to start resetting.
- 5 Press **EXIT** to exit.

6 Install channels

The first time you set up your TV, you are prompted to select a menu language and to install TV and digital radio channels (if available). This chapter provides instructions on how to re-install and fine tune channels.

Automatically install channels

This section describes how to search and store channels automatically.

Step 1 Select your menu language

- 1 Press **MENU**.
- 2 Press **▲▼◀▶** to select **[Setup] > [Installation] > [Language] > [Menu language]**.
- 3 Press **OK** or **▶** to enter **[Menu language]**.

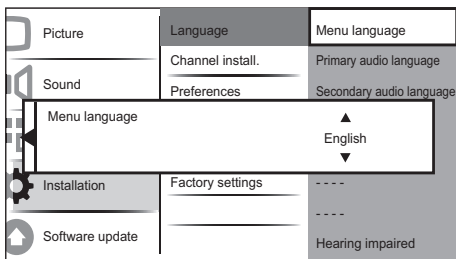

- 4 Press **▲▼** to select a language setting.
- 5 Press **OK** to confirm.
- 6 Press **◀** to return to **[Installation]** menu.

Step 2 Select your country

Select your country for proper channel installation.

- 1 Press **MENU**.
- 2 Press **▲▼◀▶** to select **[Setup] > [Installation] > [Channel install.] > [Channel assistant]**.

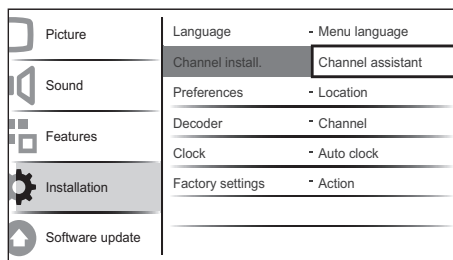

- 3 Press **OK** or **▶** to enter the menu.
↳ The country menu appears.

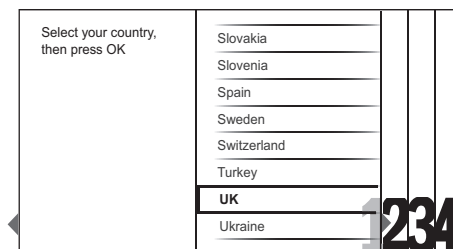

- 4 Press **▲▼** to select your country.
- 5 Press **OK** to confirm your choice.
↳ The channel installation guide appears on the screen.

Step 3 Install channels

Install the available analogue and digital TV channels and digital radio channels automatically.

- 1 From the channel installation guide screen, select **[Full installation]** to automatically install all TV channels and digital radio channels.

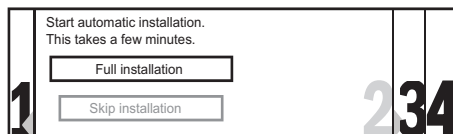

- 2 Press **OK** to confirm.
↳ The TV starts to search and store all the available channels.

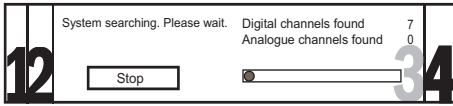

- 3 When installation is complete, press **OK** to return to **[Installation]** menu.

Step 4 Update the channel list

You can choose to enable standby mode auto update of channels. If you enable this feature, the new channels stored in your TV will be updated every morning according to the channel information in the broadcast.

- 1 Press **MENU**.
- 2 Press **▲▼◀▶** to select **[Setup]** > **[Installation]** > **[Channel install.]** > **[Standby update]**.
- 3 Select **[On]** to enable the automatic update or select **[Off]** to disable it.

Manually install channels

This section describes how to search and store analogue TV channels manually.

Step 1 Select your system

Note

- Skip this step if your system settings are correct.

- 1 Press **MENU**.
- 2 Press **▲▼◀▶** to select **[Setup]** > **[Installation]** > **[Channel install.]** > **[Analogue: Manual]**.
↳ The **[Analogue: Manual]** menu appears.

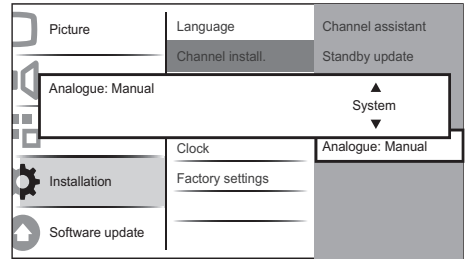

- 3 Press **OK** or **▶** to enter **[System]** menu.
- 4 Press **▲▼** to select your country or region.
- 5 Press **OK** to confirm.
- 6 Press **◀** to return to **[Channel install.]** menu.

Step 2 Search and store new TV channels

- 1 Press **MENU**.
- 2 Press **▲▼◀▶** to select **[Setup]** > **[Installation]** > **[Channel install.]** > **[Analogue: Manual]**.
↳ The **[Analogue: Manual]** menu appears.
- 3 Press **▲▼** to select **[Search]** and then **OK** or **▶** to enter **[Search]**.
- 4 Press **▲▼◀▶** to manually enter the three-digit frequency.
- 5 Press **OK** to begin search.
↳ If a channel is unavailable at the selected frequency, press **OK** to search for the next available channel.
- 6 Press **◀** when the new channel is found.
- 7 Press **▲▼** to select **[Store new channel]** to store the new channel under a new channel number.
- 8 Press **OK** or **▶** to enter **[Store new channel]** and press **OK**.
- 9 Press **◀** to return to the **[Analogue: Manual]** menu.

Step 3 Fine-tune analogue channels

- 1 Press **MENU**.
- 2 Press **▲▼◀▶** to select **[Setup]** > **[Installation]** > **[Channel install.]** > **[Analogue: Manual]**.
↳ The **[Analogue: Manual]** menu appears.
- 3 Press **▲▼** to select **[Fine-tune]** and then **OK** or **▶** to enter **[Fine-tune]**.
- 4 Press **▲▼** to adjust frequency.
- 5 Press **OK** when done.
- 6 Press **▲▼** to select **[Store current channel]** to store the fine-tuned channel under the current channel number.
- 7 Press **OK** or **▶** to enter **[Store curr. chan.]** and press **OK**.
- 8 Press **◀** to return to the **[Channel install.]** menu.

Rename channels

Channels can be renamed so that a name of your choice appears whenever the channel is selected.

- 1 When watching TV, press **OK** to display the channel grid.
- 2 Press **▲▼◀▶** to select the channel you want to rename.
- 3 Press **12** (**OPTIONS**).
↳ The channel options menu appears.
- 4 Press **▲▼** to select **[Rename channel]**.
↳ A text input box appears.
- 5 Press **▲▼◀▶** to select and change characters.
- 6 Select **[Done]** to finish renaming channels.



Tip

- Use **[Aa]** to change upper-case letter to lower-case letter and vice versa.

Reorder channels

After you install channels, you can rearrange the order in which they appear.

- 1 When watching TV, press **OK** to display the channel grid.
- 2 Press **12** (**OPTIONS**).
↳ The channel options menu appears.
- 3 Press **▲▼** to select **[Reorder]** and then **OK** to return to the channel grid.
- 4 Press **▲▼◀▶** to select the channel you want to reorder and press **OK**.
↳ The selected channel is highlighted.
- 5 Press **▲▼◀▶** to move the highlighted channel to your preferred position and press **OK**.
- 6 Press **12** (**OPTIONS**).
↳ **[Done reordering]** appears on the screen.
- 7 Press **OK** to finish reordering.

Test digital reception

If using digital broadcasts, you can check the quality and signal strength of digital channels. This allows you to reposition and test your antenna or satellite dish.

- 1 Press **MENU**.
- 2 Press **▲▼◀▶** to select **[Setup]** > **[Installation]** > **[Channel install.]** > **[Digital: test receipt]**.
- 3 Press **OK** or **▶** to enter the menu.
- 4 Press **▲▼◀▶** to enter the frequency of the channel you want to test.
- 5 Press **OK** to confirm the frequency and then press **OK** again to confirm **[Search]**.
- 6 When complete, select **[Store]** to store the frequency.



Note

- If the signal quality and strength is poor, reposition the antenna or satellite dish and retest.
- If you still have problems with the reception of your digital broadcast, contact a specialised installer.

7 Professional mode instruction

Introduction

Included in this TV is a special functional mode that allows the TV to be configured for Hospitality or Signage applications. This feature is called Professional mode.

This section has been designed to help install and operate this TV in Professional mode. Before reading this section, please read section 3 to 6 to set the basic functionality of this TV.

Benefits of Professional mode

This TV is specially designed to operate in Professional Mode. Professional Mode offers the following benefits:

- Access to the **[Consumer Menu]** can be blocked. This prevents users (e.g. guests) from deleting or changing channel settings and/or modifying picture and sound settings. This ensures that TVs are always set up correctly.
- A switch-on volume and channel can be selected. After switching on, the TV will always start on the specified volume level and channel.
- The maximum volume level of the TV can be limited in order to prevent disturbance to other guest.
- Channels can be blanked (Video only).
- The TV local buttons **VOLUME +/-**, **P/CH+/-** and **SOURCE** can be locked
- Screen information can be suppressed.

Professional Setup Remote control (2573 optional)

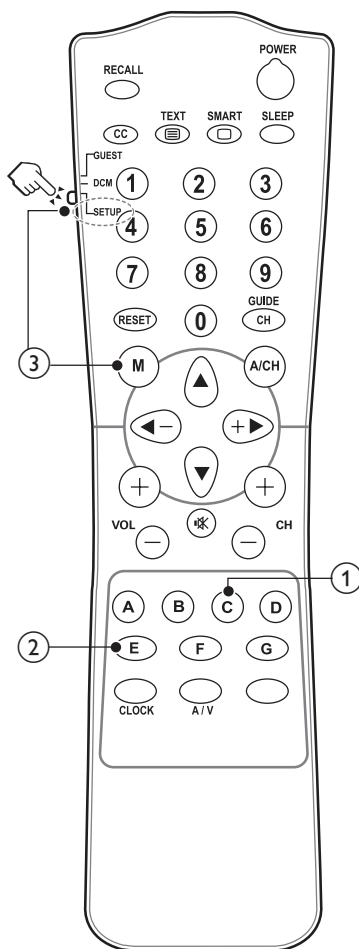

- ① **C button (OPTIONS)**
Accesses options relating to the current activity or selection. (Equals to the function of **12** (OPTIONS) on Guest remote control).
- ② **E button (OK)**
Confirms an entry or selection.
- ③ **(Enters Professional setup menu)**
 - Selects **SETUP** mode first.
 - Press **M button** to enter the Professional setup menu.

Note

- **SETUP** mode should be selected for hotel installer.

Activating the Professional mode setup menu

- 1 Switch on the TV and select a TV channel.
- 2 Press the following buttons to access Professional mode setup menu:
 - **[3, 1, 9, 7, 5, 3+MUTE]** on Guest remote control.
 - **M button** on Professional setup remote control. (When **SETUP** mode is selected on the Professional setup remote control.)
- 3 Press **▲▼◀▶** on the remote control to select and change any of the settings.
- 4 Select **[PBS settings] > [Store]** and select **[Confirm]** to save the setting. Press **MENU / EXIT** to exit Professional mode menu without saving.
- 5 For Professional mode settings to take effect, you must restart the TV mains power.

Professional mode options

This paragraph describes the functionality of each item in the Professional mode setup menu.

Layer 1	Layer 2	Layer 3
PBS settings	PBS mode	Off / On
	Application	Hospitality / Signage
	Consumer setup	Action
	Smartloader / USB to TV	Action
	TV to Smartloader / USB	Action
	Store	Action
	Reset	0~60
Switch on settings	Maximum volume	0 ~ 60
	Switch on picture format	Auto format / Super zoom / 4:3 / Subtitle Zoom / Movie expand 14:9 / Movie expand 16:9 / Wide screen / Unscaled
	Low power standby (Green / Fast)	Fast / Green
	Power on	On / Standby / Last status
	Smart power	Off / Low / Medium / High
	Display message	Off / On
	Set ID (Only available in Signage mode)	Serial Xpress Adress ID range:0~63
Switch on volume	Last status	Off / On
	User defined	0 ~ 60
Switch on channel	Last status	Off / On
	User defined	[List of channels]
Welcome message	Line 1	Edit
	Line 2	Edit
	Clear	Action
	Message Time-out	20 sec / 25 sec / 30 sec
Control settings	Local KB block	Off / On / All
	RC lock	Off / On
	OSD display	Off / On
	High security mode	Off / On
	Auto scart	Off / On (EXT 1 / EXT 2 / Power scart)
	HDMI-CEC in	Off / On
	USB break in	Off / On
	Monitor out	Off / On

Layer 1	Layer 2		Layer 3
	Enable teletext	For Prison	Off / On
	Enable MHEG		Off / On
	Enable EPG		Off / On
	Enable subtitle		Off / On
Clock setup (Only available for some models)	Display standby		Off > 1 > 2 > 3 > 4 > 5
	Display on		Off > 1 > 2 > 3 > 4 > 5
	Time setting		Time setup table
	Time download		On / Off
	Download program		List of Analogue / Digital channels.
	Time offset		GMT: -12 > ... > 0 > ... > 12
	Buzzer volume		Off / Low / High
Speaker settings	TV speaker enable		On / Off
	Independent main speaker mute		On / Off
	Default main speaker volume		0 ~ Max
Installation	Blank channel		All available channels.
	Disable auto updating		Software / Channels / Both / Off
	Skip scrambled signals		Off / On
	Smart RC		Off / On
	Multi remote control		Blue / Green / Yellow / Red / Off
Add current channel to PayTV ring	R0		All available channels.
	R1		Pay TV channel list.
	R2		Pay TV channel list

PBS settings

[PBS mode]

Enables / disables the Professional mode.

- **[On]**: All settings in the Professional mode Setup menu are in effect.
- **[Off]**: The TV operates as a normal (consumer) TV.

[Application]

1 When application is **[Hospitality]**, the following are activated.

- Last status is disabled.
- Limited Consumer menu: When in Professional mode, the guest can display the Consumer menu to adjust TV parameters. However, these settings will not be stored in TV memory.
- TV lock and parental ratings (except Sleep timer) are disabled.
- Entry into service mode is disabled in order to prevent the guest from changing service settings.

2 When application is **[Signage]**, the below functions behave as per normal consumer:

- Last status is enabled.
- The full TV menu can be accessed and changes are stored in TV memory.
- TV lock and parental ratings are enabled.
- Entry into service mode is enabled.

Note

- The default application for TV should be **[Hospitality]**, while that for monitor should be **[Signage]**.

[Consumer setup]

A shortcut to enter the full TV menu. This allows the installers to do all the TV setup settings.

Note

- Selects **[PBS settings]** > **[Store]** to save the changes in the **[Consumer setup menu]**.

[Smartloader / USB to TV]

Loads the TV configuration data (including the video, audio, channel Table, and Professional mode settings) from a Smartloader / USB device to the TV set.

[TV to Smartloader / USB]

Loads the TV configuration data (including the video, audio, channel Table, and Professional mode settings) from the TV set to a Smartloader / USB device.

[Store]

Selects **[Confirm]** to store Professional mode settings.

Note

After storing the settings, refer to page 29 “**Low power standby (Green / Fast)**”:

- When **[Fast]** is selected, you need to restart the TV mains power for the changes in Professional mode to take effect.
- When **[Green]** is selected, you need to switch the TV from standby to on again for the changes in Professional mode to take effect.

[Reset]

Selects **[Yes]** to reset all settings in Professional mode to factory default.

Switch on settings

[Maximum volume]

This option specifies the maximum allowable volume level of the TV.

[Switch on picture format]

Sets available picture format when the TV is switched on.

Note

- If the picture format is not supported with the activated source, **[Auto format]** detection is applied.

[Low power standby (Green / Fast)]

Defines the power mode when TV enters to standby by pressing remote control power button or TV local power button.

- **[Fast]:** When set, the TV will enter semi-standby mode to achieve fast powering up.
- **[Green]:** When set, the TV will enter low standby power mode to achieve minimum power consumption.

[Power on]

The power on function allows the TV to enter a specific mode (**[On]**, **[Standby]**, or **[Last status]**) of operation after the mains power is activated.

- **[On]:** When set, the TV will always turn on after the mains power is activated.
- **[Standby]:** When set, the TV will always turn to standby after the mains power is activated.
- **[Last status]:** When set, the TV will always turn to the last status (either On or Standby) whenever the mains power is activated.

[Smart power]

Adjusts the picture backlight to achieve the following power saving mode.

- **[Off]:** Smart power is disabled. (Vivid mode is applied).
- **[Low]:** The picture backlight is at low power saving mode. (Movie mode is applied).
- **[Medium]:** The picture backlight is at medium power saving mode. (Standard mode is applied).
- **[High]:** The picture backlight is at high power savings (Energy saving mode is applied).

[Display message]

- **[Off]:** Disables the display of the welcome message.
- **[On]:** Enables the display of the welcome message for a pre-defined time after the TV turns on from standby or off.

Note

- Selects **[Welcome message]** > **[Message time-out]** to set the period of time to display the welcome message.

[Set ID]

(Only available in **[Signage]** mode). This function allows installer to designate a serial ID number for each TV. Through the ID number, the installer can control each TV by using RS232-device-chaining.

Switch on volume

When the guest switches the TV on, it will play at the specified volume level.

- **[Last status]:** If **[On]** is selected, the TV will be automatically switched to the last volume status whenever the mains power is turned on. (The volume level can not exceed the **[Maximum volume]** level).
- **[User defined]:** (Only appears when you select **[Last status]** > **[Off]**.) The guest can adjust his/her preferred switch on volume level.

Switch on channel

When the guest switches the TV on, it will play at the specified channel.

- **[Last status]:** If **[On]** is selected, the TV will be automatically switched to the last channel status whenever the mains power is turned on.
- **[User defined]:** (Only appears when you select **[Last status]** > **[Off]**.) The guest can choose his/her preferred switch on channel.

Welcome message

The Welcome message function allows the TV to show a customized greeting to the hotel guest whenever the TV is switched on. This helps to personalize the hotel experience for guests. The Welcome message can consist of 2 lines of text, with each line containing a maximum of 20 alphanumeric characters. Use ▲ ▼ ◀ ▶ on the remote control to compose the Welcome message.

Note

- To activate the Welcome message, the **[Display message]** option must be **[On]**.
- Welcome message is always disabled if you select **[Control settings] > [OSD display] > [Off.]**

- **[Line 1]:** Sets the characters of the first line message.
- **[Line 2]:** Sets the characters of the second line message.
- **[Clear]:** Clear the settings in Line 1 and Line 2.
- **[Message Time-out]:** Sets the period of time to display the welcome message on the screen when TV is turned on from standby / Off.

Control settings

[Local KB lock]

- **[Off]:** The TV local buttons **VOLUME +/-**, **P/CH +/-** and **SOURCE** will function normally.
- **[On]:** The TV local buttons **VOLUME +/-**, **P/CH +/-** and **SOURCE** are locked.
- **[All]:** All TV local buttons are locked, including  **POWER** button.

[RC lock]

Disables the operation of the Guest remote control.

- **[Off]:** All buttons on Guest remote control will function normally.

- **[On]:** All buttons on the Guest remote control are disabled. (It is still possible to enter the Professional setup menu by pressing **[3, 1, 9, 7, 5, 3+MUTE]**).

[OSD display]

Sets this function to show or hide screen information.

- **[Off]:** Screen information is suppressed.
- **[On]:** Normal screen information is displayed.

[High security mode]

- **[Off]:** Professional mode setup menu can be accessed by both Guest remote control (Press **[3, 1, 9, 7, 5, 3 + MUTE]**) and the Professional setup remote control (Press **M** button)
- **[On]:** Professional mode setup menu can only be accessed by the Professional setup remote control.

[Auto scart]

Enables auto scart switching or break-in Professional mode.

- **[Off]:** Disables auto scart switching or break-in Professional mode.
- **[On]:** Enables auto scart switching or break-in Professional mode.
- **[EXT 1]:** (SCART 1)(Only available if EXT 1 source is connected to the TV). Selects EXT 1 as the auto switching source when TV restarts from standby / Off, or when EXT 1 signal is detected.
- **[EXT 2]:**(SCART 2)(Only available if EXT 2 source is connected to the TV). Selects EXT 2 as the auto switching source when TV restarts from standby / Off, or when EXT 2 signal is detected.
- **[Power scart]:** Sets scart source as power on / off button. When the connected scart source is turned on / off, the TV enters to on / standby mode simultaneously.

[HDMI-CEC in]

HDMI-CEC (Philips EasyLink) enables one-touch play and one touch standby between HDMI-CEC compliant devices.

 **Note**

- Before activating HDMI-CEC in function, make sure the HDMI-CEC compliant devices are turned to on.
- Selects **[EasyLink]** > **[On]** first before enabling **[HDMI-CEC in]** in Professional mode.
- Refer to page 40 on “*Use Philips EasyLink*” for more details about HDMI-CEC function.

- **[Off]**: Disables HDMI-CEC feature in Professional mode.
- **[On]**: Enables HDMI-CEC feature in Professional mode.

[USB break-in]

Enables or disables USB break-in feature in Professional mode.

- **[Off]**: When USB is plugged in, the **[Multimedia]** menu will not appear automatically, but users can access **[Multimedia]** menu from the **[Consumer setup]** menu.
- **[On]**: When USB is plugged in, the **[Multimedia]** menu appears automatically.

[Monitor out]

Refer to the blanking and muting of the video and audio out to prevent illegal copying of TV channels.

- **[Off]**: Disables monitor out.
- **[On]**: Enables monitor out.

 **Note**

- If SCART 1 is selected as TV input source, monitor out function will be disabled through SCART 2.

[Enable teletext]

- **[Off]**: Disables teletext in Professional mode.
- **[On]**: Enables teletext in Professional mode.

[Enable MHEG] (For UK only)

- **[Off]**: Disables MHEG in Professional mode.
- **[On]**: Enables MHEG in Professional mode.

[Enable EPG]

- **[Off]**: Disables EPG in Professional mode.
- **[On]**: Enables EPG in Professional mode.

[Enable subtitle]

- **[Off]**: Closes subtitles in Professional mode.
- **[On]**: Displays subtitles in Professional mode.

Clock setup
 **Note**

- Only applicable for the models with clock display.

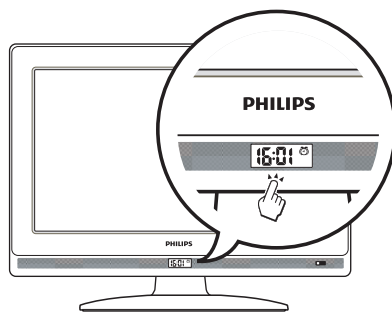
**[Display standby]**

Adjusts the brightness of clock display when the TV is in standby mode.

[Display on]

Adjusts the brightness of clock display when the TV is on.

[Time setting]

(Appears if you select **[Clock setup]** > **[Time download]** > **[Off]**) Sets the time manually.

[Time downloading]

- **[Off]:** Sets the time manually from the **[Time setting]** menu.
- **[On]:** Sets the time by downloading from the signal system in the **[Download program]** menu.

[Download program]

(Appears if you select **[Clock setup]** > **[Time download]** > **[On]**). Selects the programme where time downloading must be performed.

[Time offset]

(Appears if you select **[Clock setup]** > **[Time download]** > **[On]**) Selects the correct time zone which is downloaded from **[Download program]**.

[Buzzer volume]



Selects the volume of the clock buzzer.

How to set the TV alarm?

- 1 Selects **[Hospitality]** in the **[Application]** menu.
- 2 Sets the time either from **[Time setting]** or **[Download program]**. When set, the time will be shown on the clock display.
- 3 Press  **ALARM ON** on the Guest remote control to access the **[Alarm]** menu.
 - **[Alarm time]:** Sets the alarm time.
 - **[Alarm status]:** Displays current alarm status.
 - **[Alarm off]:** Selects **[Yes]** to cancel the alarm or **[No]** to keep the alarm enabled.



Note

- When the alarm is enabled,  icon appears on the clock display.
- Press  **ALARM OFF** on the Guest remote control to cancel the alarm,  icon disappears from the clock display simultaneously.



Speaker settings

[TV speaker enable]

- **[Off]:** Disables the TV speaker. The headphone volume functions normally.
- **[On]:** The TV speaker is enabled. (Default setting).

[Independent main speaker mute]

This option only appears when you select **[TV speaker enable]** > **[On]**.

- **[Off]:** Press  (**MUTE**) or  on the Guest remote control will affect both the TV speaker and the headphone volume (Default setting)
- **[On]:** Press  (**MUTE**) on the Guest remote control will affect the TV speaker volume only. The headphone volume functions normally.



Note

- If the TV speaker is muted independently, press  on the Guest remote control will only affect the headphone volume.

[Default main speaker volume]

Only appears when you select **[Independent main speaker mute]** > **[On]**. Users can set the TV speaker and headphone volume to a certain level as the default setting. This option can avoid sudden high-volume when TV speaker is turned on again from independently mute.

Installation

[Blank channel]

The Blank channel function disables the display of video on the TV, but does not affect the audio output. This function can be used for audio applications (example: music-only channels, and so on) which do not necessarily require the display of video.

- 1 Enters the **[Blank channel]**, the list of all channels appear.
- 2 Selects one or more channels and press **OK** to mark.
- 3 The channels marked with **[X]** will not display video on the TV.

[Disable auto updating]

- **[Software]:** Disables automatic TV software update via OAD (On the air software download).
- **[Channel]:** Disables automatic channel installation when new channels are detected.
- **[Both]:** Disables automatic update of the TV software and the channel installation.
- **[Off]:** Enables automatic update of the TV software and the channel installation.

[Skip scrambled signals]

- **[Off]:** Allows scrambled channels in the channel list.
- **[On]:** Skips the scrambled channels in the channel list.

[Smart RC]

- **[Off]:** PayTV channels are accessible via the Guest remote control.
- **[On]:** PayTV channels are only accessible via the Smoovie remote control.

[Multi remote control]

Guest remote control supports up to four televisions operating in one room without interference from each other's remote controls. Each TV and the Guest remote control can be set to match each others.

- 1 Enter **[Multi remote control]** and designate one colour (**Blue / Green / Yellow / Red**) to the TV. Select **[Off]** to disable **[Multi remote control]** function.
- 2 Set the Guest remote control to the corresponding colour by pressing **MENU** and one of the **colour button** simultaneously for more than 4 seconds.
- 3 The Guest remote control can operate the TV with the corresponding colour.

Note

- **EXAMPLE:** Press **MENU** and **Red button** simultaneously on the Guest remote control for more than 4 seconds to operate the TV with **[Red]** colour selected in **[Multi remote control]** menu.
- Guest remote control will be set to default **Blue colour** after replacing batteries.

Add current channel to PayTV ring:

This function allows you to customized PayTV channel list.

- 1 Switch to the channel you prefer to add into the PayTV ring.
- 2 Enter **[Add current channel to PayTV ring]** menu.
- 3 Select one of the PayTV ring below to mark current channel to:
 - **[R1]:** If **[Smart RC]** is **[On]**, R1 channels marked with **[X]** are only accessible via the Smoovie remote control 1.
 - **[R2]:** If **[Smart RC]** is **[On]**, R2 channels marked with **[X]** are only accessible via the Smoovie remote control 2.
- 4 Enter **[R0]** (all available channels) to unmark the channels you have marked in **[R1]** and **[R2]** to prevent users from watching full PayTV channels via Guest remote control.

Note

- All non-PayTV channels are listed in **[R0]**.

8 Connect devices

This section describes how to connect various devices with different connectors and supplements examples provided in the Quick Start.

Note

- Different types of connectors may be used to connect a device to your TV, depending on availability and your needs.

Back connector for 22 inch TV

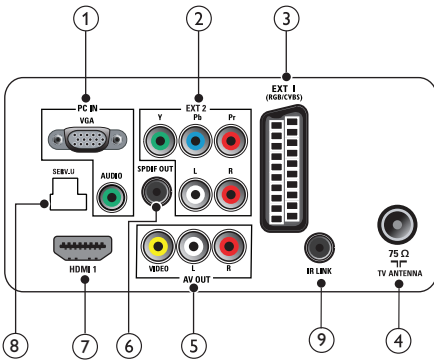

- ① PC IN (VGA and AUDIO IN)
Audio and video input from a computer.

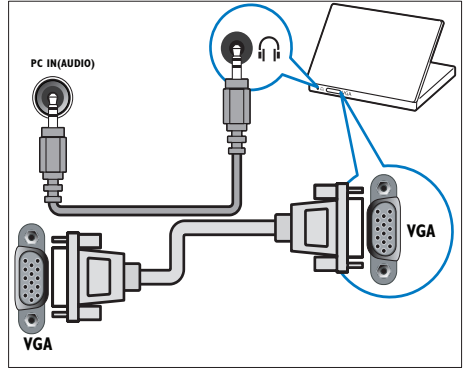

- ② EXT 2 (Y Pb Pr and AUDIO L/R)
Analogue audio and component video input from analogue or digital devices such as DVD players or game consoles.

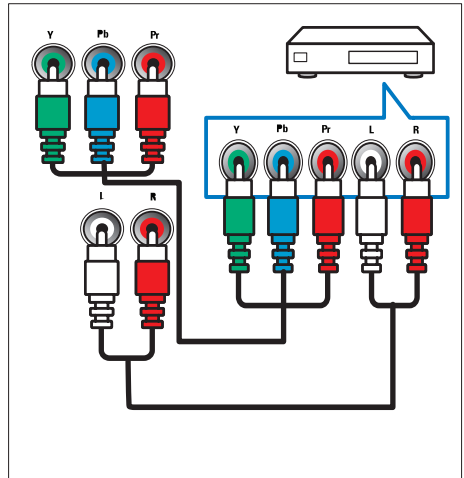

③ EXT 1 (CVBS and RGB)

Analogue audio and video input from analogue or digital devices such as DVD players or game consoles.

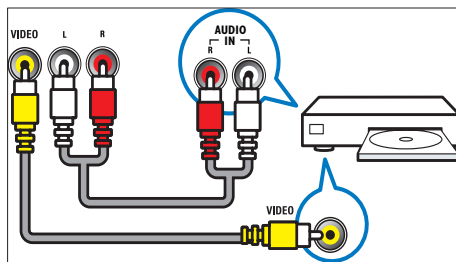
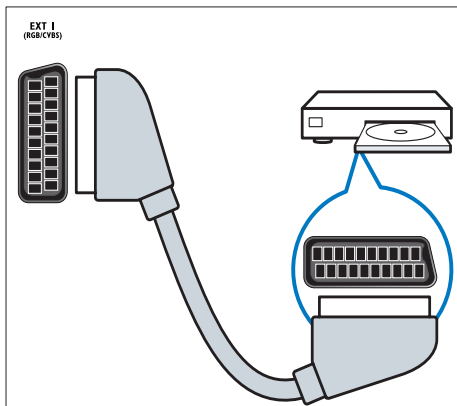

⑥ SPDIF OUT

Digital audio output to home theatres and other digital audio systems.

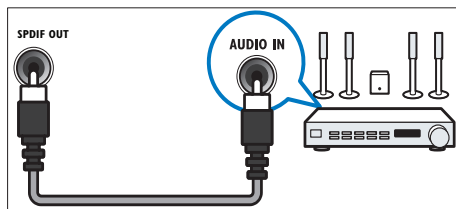

④ TV ANTENNA

Signal input from an antenna, cable or satellite.

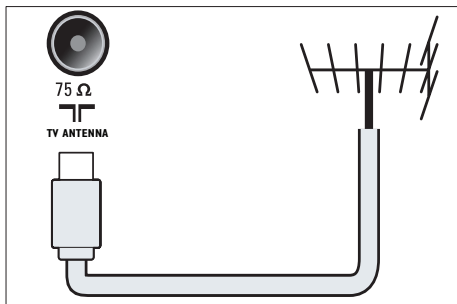

⑦ HDMI 1

Digital audio and video input from high-definition digital devices such as Blu-ray players.

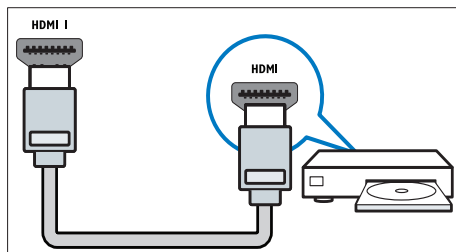

Connections via DVI or VGA require an additional audio cable.

⑤ AV OUT (VIDEO OUT and AUDIO OUT L/R)

Audio and video output to analogue devices such as another TV or a recording device.

⑧ SERV. U (For Pro+ 3v3 signal level Serial Xpress)

For technical application only.

- ⑨ **IR LINK (Only in some models)**
Connector for an IR Link compliant device. (e.g. set-up box).

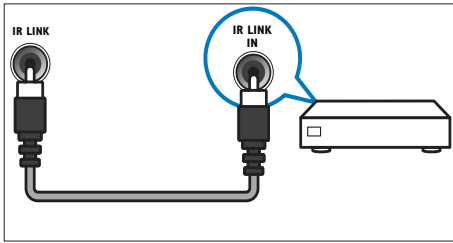

Back connector for 26 inch TV and larger

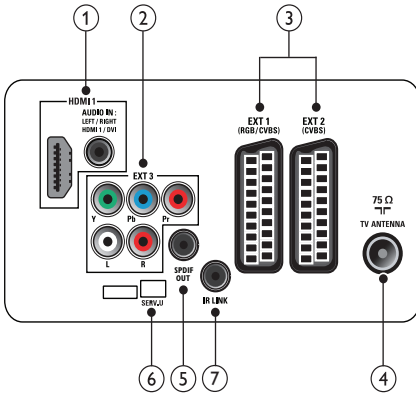

- ① **HDMI 1 (HDMI and AUDIO IN)**
Digital audio and video input from high-definition digital devices such as Blu-ray players.

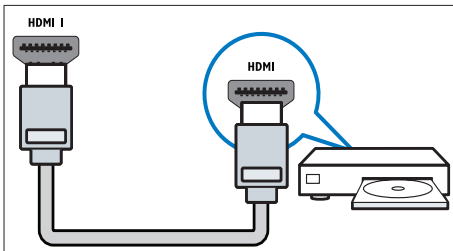

Audio input from devices that require a separate audio connection, such as a computer.
Connections via DVI or VGA require an additional audio cable.

- ② **EXT 3 (Y Pb Pr and AUDIO L/R)**
Analogue audio and component video input from analogue or digital devices such as DVD players or game consoles.

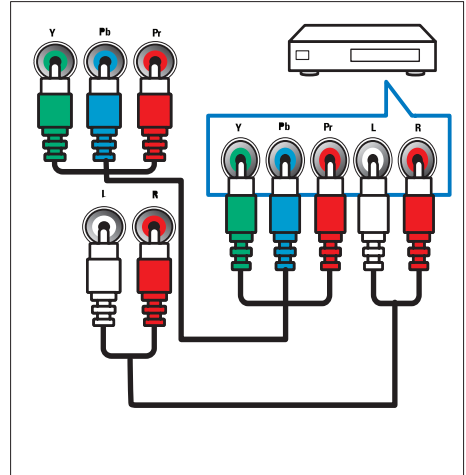

- ③ **EXT 1 (RGB and CVBS)/EXT 2 (CVBS)**
Analogue audio and video input from analogue or digital devices such as DVD players or game consoles. EXT 2 supports S-Video.

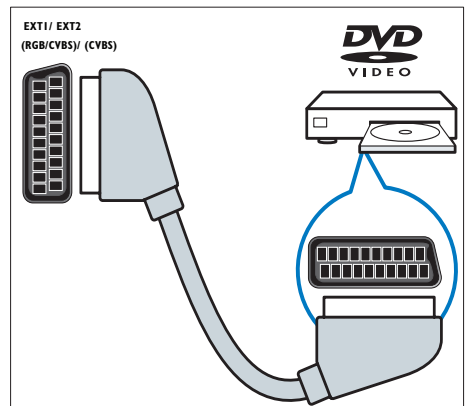

4 TV ANTENNA

Signal input from an antenna, cable or satellite.

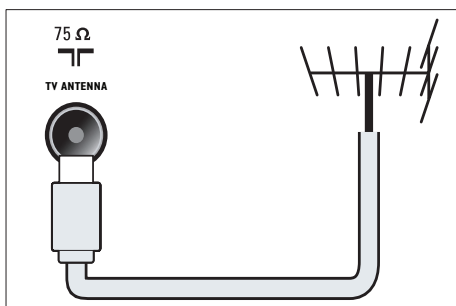

5 SPDIF OUT

Digital audio output to home theatres and other digital audio systems.

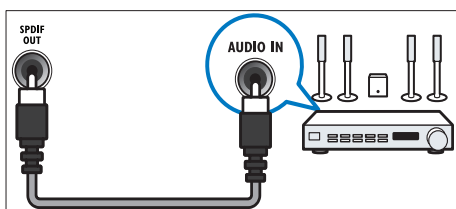

6 SERV. U (For Pro+ 3v3 signal level Serial Xpress)

For technical application only.

7 IR LINK (Only in some models)

Connector for an IR Link compliant device. (e.g. set-up box).

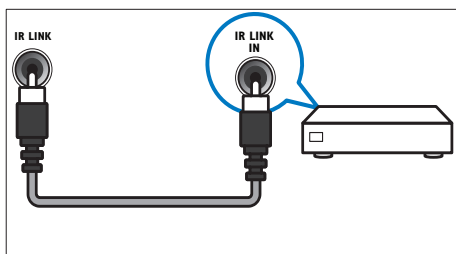

Side connector

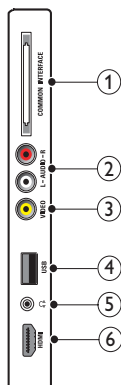

1 COMMON INTERFACE

Slot for a Conditional Access Module (CAM).

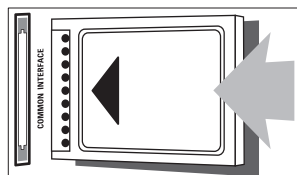

2 AUDIO L/R

Audio input from analogue devices connected to VIDEO.

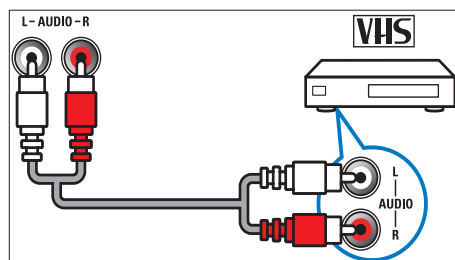

3 VIDEO

Composite video input from analogue devices such as VCRs.

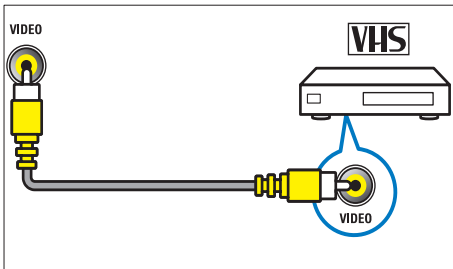

4 USB

Data input from USB storage devices.

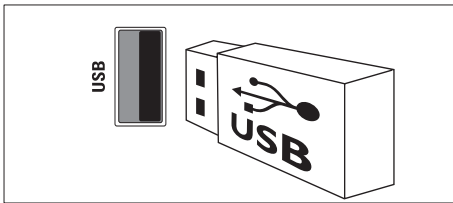

5 (Headphone)

Stereo audio output to headphones or earphones.

6 HDMI (Only for TVs 26 inches and larger)

Digital audio and video input from high-definition digital devices such as Blu-ray players.

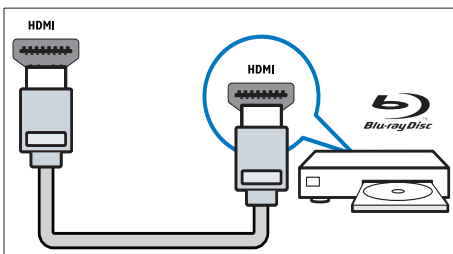

Connect a computer

Before you connect a computer to the TV

- Set the screen refresh rate on your computer to 60Hz.
- Select a supported screen resolution on your computer.

Connect a computer with one of the following connectors:

Note

- Connections via DVI or VGA require an additional audio cable.

• HDMI cable

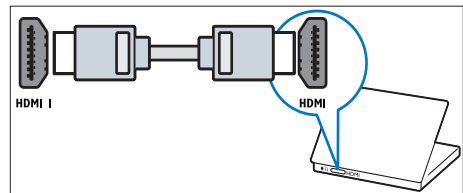

• DVI-HDMI cable

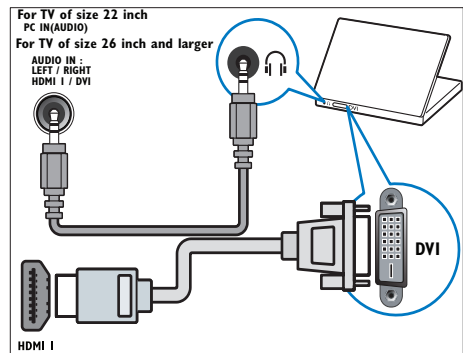

• HDMI cable and HDMI-DVI adaptor

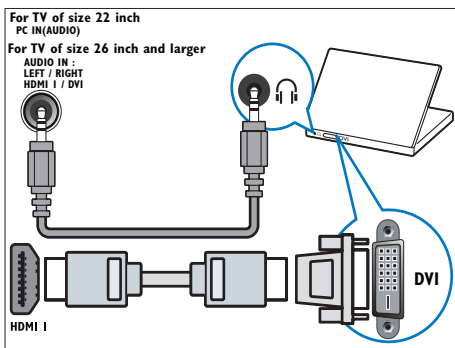

• VGA cable

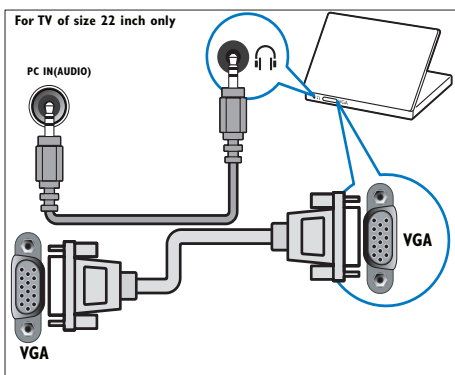

Use a Conditional Access Module

A Conditional Access Module (CAM) is provided by digital TV service operators to decode digital TV channels.

Note

- If required, refer to documentation from your operator on how to insert a smart card into the Conditional Access Module.

Insert and activate a CAM

! Caution

- Be sure to follow the instructions described below. Wrong insertion of a CAM may damage both the CAM and your TV.

- 1 Switch off the TV.
- 2 Following the directions printed on the CAM, gently insert the CAM into the **COMMON INTERFACE** at the side of the TV.

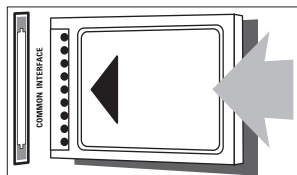

- 3 Push the CAM in as far as it will go.
- 4 Turn on the TV and wait for the CAM to be activated. This may take several minutes. Do not remove the CAM from the slot when in use — removing the CAM will deactivate digital services.

Access CAM services

- 1 After inserting and activating the CAM, press **MENU**.
- 2 Press **▲▼◀▶** to select **[Setup] > [Features] > [Common interface]**.
 - ↳ Applications provided by the digital TV service operator appear on the screen.

≡ Note

- This menu option is available only if the CAM is inserted and activated correctly.

Use Philips EasyLink

Your TV supports Philips EasyLink, which enables one-touch play and one-touch standby between EasyLink-compliant devices.

Note

- Compliant devices must be connected to your TV via HDMI.

Enable or disable EasyLink

Note

- Do not enable Philips EasyLink if you do not intend to use it.

- 1 Press **MENU**.
- 2 Press **▲▼◀▶** to select **[Setup] > [Installation] > [Preferences] > [EasyLink]**.
- 3 Select **[On]** or **[Off]**.

Use one-touch play

- 1 After enabling EasyLink, press play on your device.
 - ↳ The TV automatically switches to the correct source.

Use one-touch standby

- 1 Press and hold **⏻Standby** on the TV's or device's remote control for at least three seconds.
 - ↳ The TV and all connected HDMI devices switch to standby.

Use a Kensington lock

There is a Kensington security slot at the back of the TV. Prevent theft by looping a Kensington lock between the slot and a permanent object, such as a heavy table.

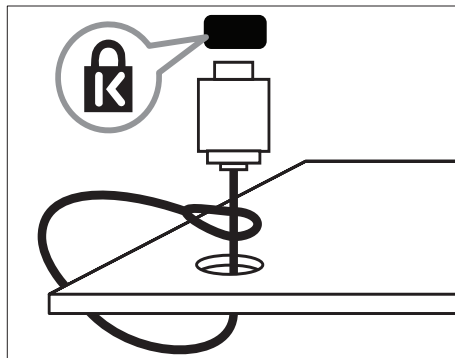

9 Product information

Product information is subject to change without notice. For detailed product information, go to www.philips.com/support.

Supported display resolutions

Computer formats

- **Resolution** - refresh rate:
 - 640 × 480 - 60Hz
 - 800 × 600 - 60Hz
 - 1024 × 768 - 60Hz
 - 1280 × 720 - 60Hz
 - 1280 × 768 - 60Hz
 - 1280 × 1024 - 60 Hz
 - 1360 × 768 - 60 Hz
 - 1440 × 900 - 60Hz (For Full HD only)
 - 1680 × 1050 - 60Hz (For Full HD only)
 - Via HDMI/DVI input

Video formats

- **Resolution** - refresh rate:
 - 480i - 60Hz
 - 480p - 60Hz
 - 576i - 50Hz
 - 576p - 50Hz
 - 720p - 50Hz, 60Hz
 - 1080i - 50Hz, 60Hz
 - 1080p - 24Hz, 25Hz, 30Hz, 50Hz, 60Hz.

Multimedia

- **Supported** storage device: USB (Only FAT or FAT 32 USB storage devices are supported)
- **Supported** multimedia file formats:
 - **Images:** JPEG
 - **Audio:** MP3



Note

- Multimedia file names must not exceed 128 characters.

Tuner/Reception/Transmission

- **Aerial** input: 75ohm coaxial (IEC75)
- **DVB:** DVB Terrestrial, DVB-T MPEG4 (only in some models)
- **TV system:** DVB COFDM 2K/8K; PAL I, B/G, D/K; SECAM B/G, D/K, L/L'
- **Video** playback: NTSC, SECAM, PAL
- **Tuner** Bands: Hyperband, S-channel, UHF, VHF

Remote control

- **Type:** RC-6
- **Batteries:** 2 × AAA (LR03 type)

Power

- **Mains** power: 220-240V, 50Hz ~ 60Hz
- **Standby** power: < 0.3W
- **Ambient** temperature: 5 to 40 degrees Celsius

Supported TV mounts

To mount the TV, purchase a Philips TV mount or a VESA-compatible TV mount. To prevent damage to cables and connectors, be sure to leave a clearance of at least 2.2 inches or 5.5cm from the back of the TV.



Warning

- Follow all instructions provided with the TV mount. Koninklijke Philips Electronics N.V. bears no responsibility for improper TV mounting that results in accident, injury or damage.

TV screen size (inches)	Required pitch (mm)	Required mounting bolts
22	100 × 100	4 × M4
26	100 × 200	6 × M4
32	200 × 200	4 × M6

10 Troubleshooting

This section describes commonly encountered issues and accompanying solutions.

General TV issues

The TV does not switch on:

- Disconnect the power cable from the power outlet. Wait for one minute then reconnect it.
- Check that the power cable is securely connected.

The remote control is not working properly:

- Check that the remote control are correctly inserted according to the +/- orientation.
- Replace the remote control batteries if they are flat or weak.
- Clean the remote control and TV sensor lens.

The standby light on the TV blinks red:

- Disconnect the power cable from the power outlet. Wait until the TV cools down before reconnecting the power cable. If the blinking reoccurs, contact Philips Consumer Care.

You forgot the code to unlock the TV lock feature

- Enter '8888'.

The TV menu is in the wrong language.

- Change the TV menu to your preferred language.

When turning the TV on/off to standby, you hear a creaking sound from the TV chassis:

- No action is required. The creaking sound is normal expansion and contraction of the TV as it cools down and warms up. This does not impact performance.

When TV start-up time is slow:

- Select **[Fast]** mode in **[Low power standby]** menu.

TV channel issues

Previously installed channels do not appear in the channel list:

- Check that the correct channel list is selected.

No digital channels were found during the installation:

- Check that the TV supports DVB-T or DVB-C in your country. See the listed countries on the back of the TV.

Picture issues

The TV is on, but there is no picture:

- Check that the antenna is properly connected to the TV.
- Check that the correct device is selected as the TV source.

There is sound but no picture:

- Check that the picture settings are correctly set.

There is poor TV reception from an antenna connection:

- Check that the antenna is properly connected to the TV.
- Loudspeakers, unearthed audio devices, neon lights, high buildings and other large objects can influence reception quality. If possible, try to improve the reception quality by changing the antenna direction or moving devices away from the TV.
- If reception on only one channel is poor, fine tune this channel.

There is poor picture quality from connected devices:

- Check that the devices are connected properly.
- Check that the picture settings are correctly set.

The TV did not save your picture settings:

- Check that the TV location is set to the home setting. This mode offers you the flexibility to change and save settings.

The picture does not fit the screen; it is too big or too small:

- Try using a different picture format.

The picture position is incorrect:

- Picture signals from some devices may not fit the screen correctly. Check the signal output of the device.

Sound issues

There is a picture but sound quality is poor:

Note

- If no audio signal is detected, the TV automatically mutes the audio output — this does not indicate malfunction.

- Check that all cables are properly connected.
- Check that the volume is not set to 0.
- Check that the sound is not muted.

There is a picture but the sound quality is poor:

- Check that the sound settings are correctly set.

There is a picture but sound comes from one speaker only:

- Verify that sound balance is set to the centre.

HDMI connection issues

There are problems with HDMI devices:

- Note that HDCP support can delay the time taken for a TV to display content from a HDMI device.
- If the TV does not recognize the HDMI device and no picture is displayed, try switching the source from one device to another and back again.
- If there are intermittent sound disruptions, check that output settings from the HDMI device are correct.

- If a HDMI-to-DVI adaptor or HDMI to DVI cable is used, check that an additional audio cable is connected to **AUDIO L/R** or **AUDIO IN** (mini-jack only).

Computer connection issues

The computer display on the TV is not stable:

- Check that a supported resolution and refresh rate is selected on the computer.
- Set the TV picture format to unscaled.

Contact us

If you cannot resolve your problem, refer to the FAQs for this product at www.philips.com/support.

If the problem remains unresolved, contact Philips Consumer Care in your country as listed in the warranty leaflet.



Warning

- Do not attempt to repair the product yourself. This may cause severe injury, irreparable damage to your product or void your warranty.



Note

- Make a note of your TV model and serial number before you contact Philips. These numbers are printed on the back of the TV and on the packaging.

Index

A	
ALARM	7, 32
Application	
Hospitality	28
Signage	28

B	
Batteries	41

C	
Channel list	
install	
Automatic	21
Manual	22
PayTV ring	33
Test digital reception	23
Troubleshooting	42
Update	22
clock	16
setup	31
Computer	
Connect	38
display resolutions	41
Troubleshooting	43

D	
DEMO	20
Digital channels	
CAM	39
Test digital reception	23
Display resolutions	41

E	
EasyLink	
disable	40
Enable	40
one-touch play	40
one-touch standby	40
EPG	14
Professional mode EPG	31

F	
factory settings	20

H	
HDMI	
HDMI-CEC in	31
Troubleshooting	43
Hospitality	28

I	
Installation	
Automatic	21
Manual	22

K	
Kensington lock	40

L	
Language	
Audio language	13
menu language	21
subtitle language	16
Troubleshooting	42
Lock	
Kensington lock	40
Local KB lock	30
Low power standby	29

M	
MENU	
Main menu	10
Troubleshooting	42
Monitor out	31
Multimedia	
Technical specifications	41
USB	17
Multi remote control	33
Music	18

O	
One-touch play	40
One-touch standby	40

P		
Photo		
Slide show	17	
USB	17	
Picture format	12	
Picture settings	10	
POWER	8	
Low power standby	29	
Power on	29	
Smart power	29	
Technical specifications	41	
Professional mode		
Activat	25	
Options	26	
PBS mode	28	
Settings	28	
R		
Remote control		
Professional Setup Remote control	24	
RC lock	30	
Technical specifications	41	
Troubleshooting	42	
S		
Signage	28	
Smart card	39	
Smart settings	12	
Software version	18	
Sound settings	12	
Subtitles		
On analogue channels	15	
On digital channels	16	
Professional mode subtitle	31	
T		
Technical specifications	41	
Teletext	9, 13	
Troubleshooting	42	
TV overview	6	
U		
USB		
Listen to music	18	
USB break-in	31	
View photos	17	
V		
Video formats	41	
Volum	9	
Volume	7	
W		
Wall mounts	41	
Welcome message	30	

Information about how to re-tune your TV during the digital TV switchover.

Keep this user manual safe – you'll need it.

.....

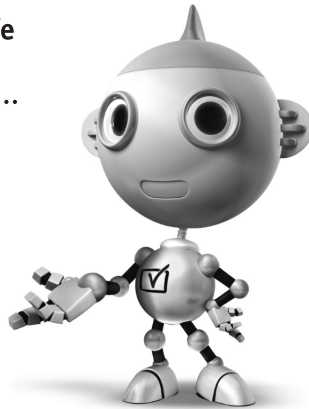

Television in the UK is going digital, bringing us all more choice and new services. Starting in late 2007 and ending in 2012, television services in the UK will go completely digital, TV region by TV region.

Please see the next page to find out when your area switches to digital.

Digital UK is the independent, non-profit organisation leading the process of digital TV switchover in the UK. Digital UK provides impartial information on what people need to do to prepare for the move to digital, and when they need to do it.

How the switchover affects your TV equipment:

Your new TV has a digital tuner built in, which means it is ready to receive the Freeview signal by simply plugging it into your aerial socket (check if you can get digital TV through your aerial now, or whether you'll have to wait until switchover, at www.digitaluk.co.uk).

When the TV switchover happens in your area, there are at least two occasions when you will need to re-tune your TV in order to continue receiving your existing TV channels, and also to pick up new ones.

get set for digital 

Digital UK, the body leading the digital TV switchover, will advise you when you need to re-tune during the switchover.

If you choose to connect your TV to satellite or cable with a digital box then it will not be affected by switchover, and you won't need to re-tune.

If you have any questions, please contact your equipment supplier or call Digital UK on ... 0845 6 50 50 50 or visit www.digitaluk.co.uk

How to re-tune:

To find out how to re-tune your TV, check this user manual for details.

Go to section **6 Install channels**.

If you do not re-tune your channels when advised to do so by Digital UK, you may lose some or all of your channels until you do re-tune. You should re-tune your TV every few months to check for any new channels.

If you are missing any channels, it may be that they are not available in your area, or that your aerial needs upgrading.

When does switchover happen?

*Copeland switches on October 17, 2007

The exact date you switch depends on the transmitter you are served by. To check when you switch, go to Digital UK's postcode checker on www.digitaluk.co.uk

Check your ITV news service or look at Teletext page 106 to see what TV region you're in.

Visit us at digitaluk.co.uk
Call us on **0845 6 50 50 50†**

† Calls charged at BT rate of 3p per minute daytime and 1p per minute evenings and weekends. Rates may vary for calls from non-BT lines.

