



www.philips.com/welcome

EN User manual	1
Customer care and warranty	37
Troubleshooting & FAQs	52

Table of Contents

1. Important	1
1.1 Safety precautions and maintenance.....	1
1.2 Notational Descriptions.....	2
1.3 Disposal of product and packing material....	3
2. Setting up the monitor	4
2.1 Installation.....	4
2.2 Operating the monitor.....	5
2.3 Remove the Base.....	8
3. Image Optimization	9
3.1 SmartImage.....	9
3.2 SmartContrast.....	10
3.3 SmartSaturate.....	11
3.4 SmartSharpness.....	11
3.5 Philips SmartControl Premium.....	12
3.6 SmartDesktop Guide.....	20
4. Technical Specifications	25
4.1 Resolution & Preset Modes.....	29
5. Power Management	30
5.1 Automatic PowerSaving.....	30
6. Regulatory Information	31
7. Customer care and warranty	37
7.1 Philips' Flat Panel Monitors Pixel Defect Policy.....	37
7.2 Customer Care & Warranty.....	39
8. Troubleshooting & FAQs	52

1. Important

This electronic user's guide is intended for anyone who uses the Philips monitor. Take time to read this user manual before you use your monitor. It contains important information and notes regarding operating your monitor.

The Philips guarantee applies provided the product is handled properly for its intended use, in accordance with its operating instructions and upon presentation of the original invoice or cash receipt, indicating the date of purchase, dealer's name and model and production number of the product.

1.1 Safety precautions and maintenance

Warnings

Use of controls, adjustments or procedures other than those specified in this documentation may result in exposure to shock, electrical hazards and/or mechanical hazards.

Read and follow these instructions when connecting and using your computer monitor:

Operation

- Keep the monitor out of direct sunlight and away from stoves or any other heat source.
- Remove any object that could fall into ventilation holes or prevent proper cooling of the monitor's electronics.
- Do not block the ventilation holes on the cabinet.
- When positioning the monitor, make sure the power plug and outlet are easily accessible.
- If turning off the monitor by detaching the power cable or DC power cord, wait for 6 seconds before attaching the power cable or DC power cord for normal operation.
- Please use approved power cord provided by Philips all the time. If your power cord is missing, please contact with your local service center. (Please refer to Customer Care Consumer Information Center)

- Do not subject the monitor to severe vibration or high impact conditions during operation.
- Do not knock or drop the monitor during operation or transportation.

Maintenance

- To protect your monitor from possible damage, do not put excessive pressure on the monitor panel. When moving your monitor, grasp the frame to lift; do not lift the monitor by placing your hand or fingers on the monitor panel.
- Unplug the monitor if you are not going to use it for an extensive period of time.
- Unplug the monitor if you need to clean it with a slightly damp cloth. The screen may be wiped with a dry cloth when the power is off. However, never use organic solvent, such as, alcohol, or ammonia-based liquids to clean your monitor:
- To avoid the risk of shock or permanent damage to the set, do not expose the monitor to dust, rain, water, or excessive moisture environment.
- If your monitor gets wet, wipe it with dry cloth as soon as possible.
- If foreign substance or water gets in your monitor, please turn the power off immediately and disconnect the power cord. Then, remove the foreign substance or water; and send it to the maintenance center.
- Do not store or use the monitor in locations exposed to heat, direct sunlight or extreme cold.
- In order to maintain the best performance of your monitor and use it for a longer lifetime, please use the monitor in a location that falls within the following temperature and humidity ranges.
 - Temperature: 0-40°C 32-95°F
 - Humidity: 20-80% RH

- **IMPORTANT:** Always activate a moving screen saver program when you leave your monitor unattended. Always activate a periodic screen refresh application if your monitor will display unchanging static content. Uninterrupted display of still or static images over an extended period may cause "burn in", also known as "after-imaging" or "ghost imaging", on your screen.
- "Burn-in", "after-imaging", or "ghost imaging" is a well-known phenomenon in monitor panel technology. In most cases, the "burned in" or "after-imaging" or "ghost imaging" will disappear gradually over a period of time after the power has been switched off.

Warning

Severe "burn-in" or "after-image" or "ghost image" symptoms will not disappear and cannot be repaired. The damage mentioned above is not covered under your warranty.

Service

- The casing cover should be opened only by qualified service personnel.
- If there is any need for any document for repair or integration, please contact with your local service center. (please refer to the chapter of "Consumer Information Center")
- For transportation information, please refer to "Technical Specifications".
- Do not leave your monitor in a car/trunk under direct sun light.

Note

Consult a service technician if the monitor does not operate normally, or you are not sure what procedure to take when the operating instructions given in this manual have been followed.

1.2 Notational Descriptions

The following subsections describe notational conventions used in this document.

Notes, Cautions and Warnings

Throughout this guide, blocks of text may be accompanied by an icon and printed in bold or italic type. These blocks contain notes, cautions or warnings. They are used as follows:

Note

This icon indicates important information and tips that help you make better use of your computer system.

Caution

This icon indicates information that tells you how to avoid either potential damage to hardware or loss of data.

Warning

This icon indicates the potential for bodily harm and tells you how to avoid the problem.

Some warnings may appear in alternate formats and may not be accompanied by an icon. In such cases, the specific presentation of the warning is mandated by the relevant regulatory authority.

1.3 Disposal of product and packing material

Waste Electrical and Electronic Equipment- WEEE



This marking on the product or on its packaging illustrates that, under European Directive 2002/96/EC governing used electrical and electronic appliances, this product may not be disposed of with normal household waste. You are responsible for disposal of this equipment through a designated waste electrical and electronic equipment collection. To determine the locations for dropping off such waste electrical and electronic, contact your local government office, the waste disposal organization that serves your household or the store at which you purchased the product.

Your new monitor contains materials that can be recycled and reused. Specialized companies can recycle your product to increase the amount of reusable materials and to minimize the amount to be disposed of.

All redundant packing material has been omitted. We have done our utmost to make the packaging easily separable into mono materials.

Please find out about the local regulations on how to dispose of your old monitor and packing from your sales representative.

Recycling Information for Customers

Your display is manufactured with high quality materials and components which can be recycled and reused.

To learn more about our recycling program please visit www.philips.com/about/sustainability/recycling.

2. Setting up the monitor

2.1 Installation

1 Package contents

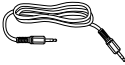
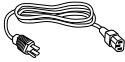
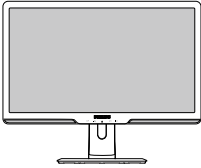

VGA signal cable (optional)



DVI cable (optional)

2 Connecting to your PC

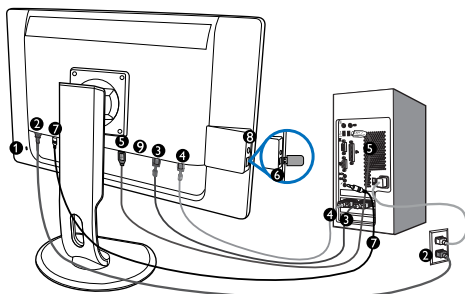

- ❶ Kensington anti-theft lock
- ❷ AC power input
- ❸ DVI-D input (available for selecting model)
- ❹ VGA input
- ❺ USB upstream
- ❻ USB downstream
- ❼ Audio input
- ❽ Earphone jack
- ❾ Display port (241P3Y/241P3LY)

Connect to PC

1. Connect the power cord to the back of the monitor firmly.
2. Turn off your computer and unplug its power cable.
3. Connect the monitor signal cable to the video connector on the back of your computer.
4. Connect the PC audio cable to the audio connector on the back of your computer.
5. Plug the power cord of your computer and your monitor into a nearby outlet.
6. Connect the USB upstream port on the monitor and the USB port on your computer with a USB cable. The USB downstream port is now ready for any USB device to plug in.
7. Turn on your computer and monitor. If the monitor displays an image, installation is complete.

2.2 Operating the monitor

1 Front view product description

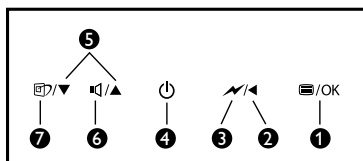
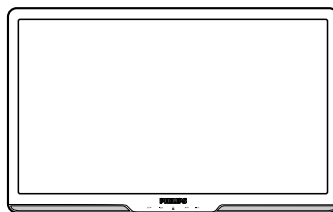

- ❶ : To access OSD menu.
- ❷ : Return to previous OSD level.
- ❸ : Dim down up to 50% of brightness level by one touch.
- ❹ : To switch monitor's power on and off.
- ❺ : To adjust the OSD menu.
- ❻ : To adjust volume of the display.
- ❼ : SmartImage. There are 6 modes to be selected: Office, Photo, Movie, Game, Economy and Off.

2 Description of the On Screen Display

What is On-Screen Display (OSD)?

On-Screen Display (OSD) is a feature in all Philips monitors. It allows an end user to adjust screen performance or select functions of the monitors directly through an on-screen instruction window. A user friendly on screen display interface is shown as below:

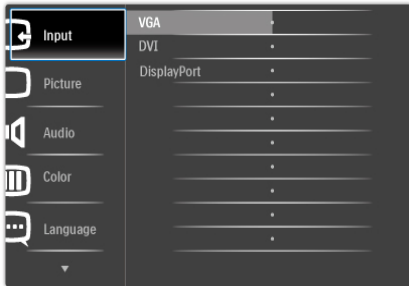

Basic and simple instruction on the control keys

In the OSD shown above users can press ▼▲ buttons at the front bezel of the monitor to move the cursor; **OK** to confirm the choice or change.

The OSD Menu

Below is an overall view of the structure of the On-Screen Display. You can use this as a reference when you want to work your way around the different adjustments later on.

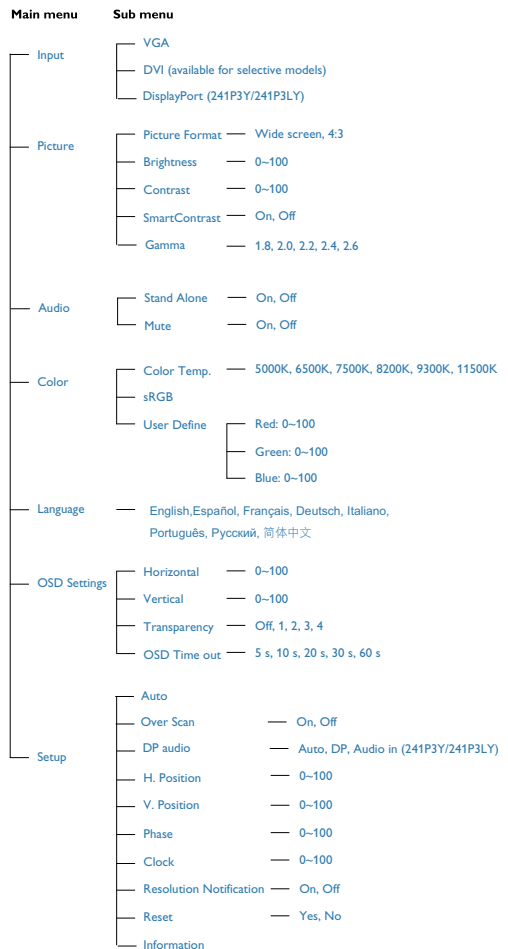

3 Resolution notification

This monitor is designed for optimal performance at its native resolution, 1920x1080@60Hz.

When the monitor is powered on at a different resolution, an alert is displayed on screen: Use 1920x1080@60Hz for best results.

Display of the native resolution alert can be switched off from Setup in the OSD (On Screen Display) menu.

4 Physical Function

Tilt

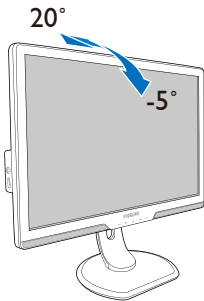

Swivel

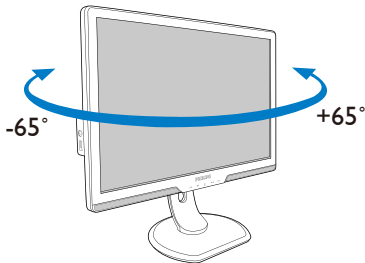

Height adjustment

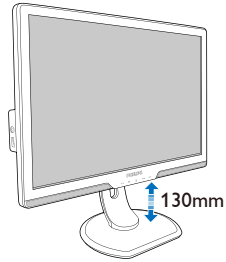

Pivot

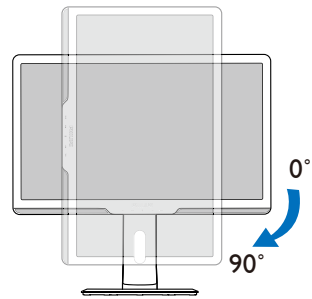

2.3 Remove the Base

Condition:

- For VESA standard mounting applications

Before you start disassembling the monitor base, please follow the instructions below to avoid damage or injury.

1. Remove the 4 screw covers.

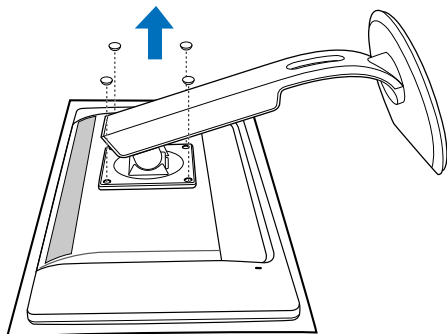

2. Remove the 4 screws and then remove the base from the monitor.

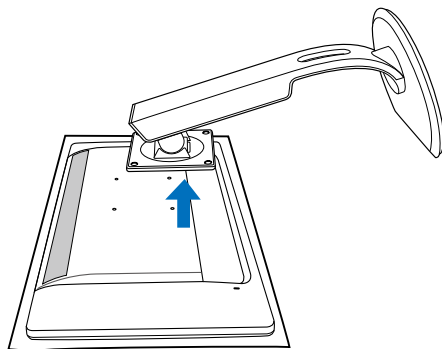
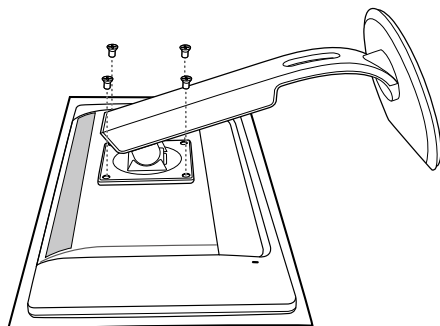
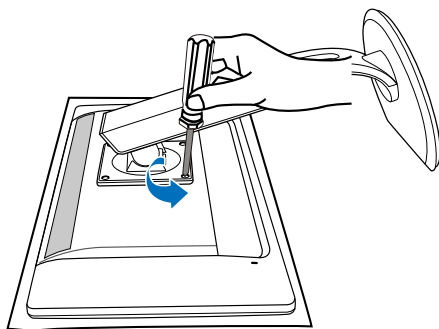

Note

This monitor accepts a 100mm x 100mm VESA-Compliant mounting interface.

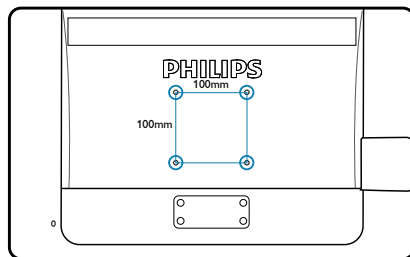

3. Image Optimization

3.1 SmartImage

1 What is it?

SmartImage provides presets that optimize display for different types of content, dynamically adjusting brightness, contrast, color and sharpness in real time. Whether you're working with text applications, displaying images or watching a video, Philips SmartImage delivers great optimized monitor performance.

2 Why do I need it?



You want a monitor that delivers optimized display all your favorite types of content, SmartImage software dynamically adjust brightness, contrast, color and sharpness in real time to enhance your monitor viewing experience.

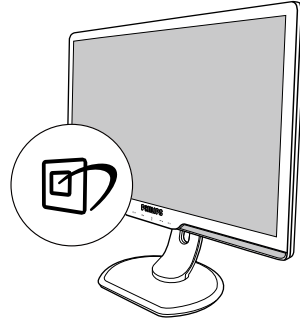

3 How does it work?

SmartImage is an exclusive, leading edge Philips technology that analyzes the content displayed on your screen. Based on a scenario you select, SmartImage dynamically enhances the contrast, color saturation and sharpness of images to enhance the contents being displayed - all in real time with the press of a single button.

4 How to enable SmartImage?



1. Press  to launch the SmartImage on screen display;
2. Keep pressing  to toggle between Office, Photo, Movie, Game, Economy and Off;
3. The SmartImage on screen display will remain on screen for 5 seconds or you can also press "OK" to make confirmation.
4. When SmartImage is enabled, the sRGB scheme is disabled automatically. To use sRGB you need to disable SmartImage with the  button at the front bezel of your monitor.

Except using  key to scroll down, you can also press   buttons to choose and press "OK" to confirm selection and close the SmartImage OSD.

There are six modes to be selected: Office, Photo, Movie, Game, Economy and Off.

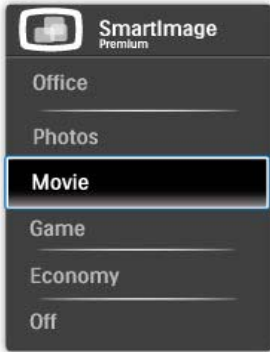

- **Office:** Enhances text and dampens brightness to increase readability and reduce eye strain. This mode significantly enhances readability and productivity when you're working with spreadsheets, PDF files, scanned articles or other general office applications.
- **Photo:** This profile combines color saturation, dynamic contrast and sharpness enhancement to display photos and other images with outstanding clarity in vibrant colors - all without artifacts and faded colors.
- **Movie:** Ramped up luminance, deepened color saturation, dynamic contrast and razor sharpness displays every details in darker areas of your videos without color washout in brighter areas maintaining a dynamic natural values for the ultimate video display
- **Game:** Turn on over drive circuit for best response time, reduce jaggy edges for fast moving objects on screen, enhance contrast ratio for bright and dark scheme, this profile delivers the best gaming experience for gamers.
- **Economy:** Under this profile, brightness, contrast are adjusted and backlighting fine-tuned for just right display of everyday office applications and lower power consumption.
- **Off:** No optimization by SmartImage.

3.2 SmartContrast

1 What is it?

Unique technology that dynamically analyzes displayed content and automatically optimizes a monitor's contrast ratio for maximum visual clarity and viewing enjoyment, stepping up backlighting for clearer, crisper and brighter images or dimming backlighting for clear display of images on dark backgrounds.

2 Why do I need it?

You want the very best visual clarity and viewing comfort for every type of content. SmartContrast dynamically controls contrast and adjusts backlighting for clear, crisp, bright gaming and video images or displays clear, readable text for office work. By reducing your monitor's power consumption, you save on energy costs and extend the lifetime of your monitor.

3 How does it work?

When you activate SmartContrast, it will analyse the content you are displaying in real time to adjust colors and control backlight intensity. This function will dynamically enhance contrast for a great entertainment experience when viewing videos or playing games.

3.3 SmartSaturate

1 What is it?

Smart technology that controls color saturation, the degree to which one on screen color is blended in neighboring colors, to deliver rich and vibrant images for more entertainment fun when you are viewing videos.

2 Why do I need it?

You want rich, vibrant images for more entertainment fun when viewing photos or videos.

3 How does it work?

SmartSaturate dynamically controls color saturation, the degree to which on-screen color is blended in neighboring colors, to deliver rich, vibrant display for more entertainment fun when you are viewing images or videos in your display's Movie or Game mode. It is turned off for top quality display of office application and in the Economy mode to reduce power consumption.

3.4 SmartSharpness

1 What is it?

Smart technology that enhances sharpness when you need it for ultimate display performance and more entertainment fun when you are viewing videos or photos.

2 Why do I need it?

You want the ultimate in sharpness for more entertainment fun when viewing photos or videos.

3 How does it work?

Smart technology enhances sharpness when you need it for ultimate display performance and more entertainment fun when you are viewing videos or photos in the Movie or Game mode. It is turned off for top quality display of office applications and in the Economy mode to reduce power consumption.

3.5 Philips SmartControl Premium

The new SmartControl Premium software by Phillips allows you to control your monitor via an easy to use on-screen graphic interface. Complicated adjustments are a thing of the past as this user friendly software guides you through fine-tuning resolution, Color calibration, Clock/Phase adjustments, RGB White point adjustment, etc.

Equipped with latest technology in core algorithm for fast processing and response, this Windows 7 compliant eye catching animated Icon based software is ready to enhance your experience with Philips monitors!

1 Installation

- Follow the instruction and complete the installation.
- You can launch after installation is completed.
- If you want to launch later, you can either click the shortcut on desktop or toolbar:



First launch -Wizard

- The first time after installation of SmartControl Premium, it will automatically go to Wizard for first time launch.
- The wizard will guide you through adjustment your monitor performance step by step.
- You can go to Plug-in menu to launch wizard later on as well.
- You can adjust more options without wizard by Standard pane.



2 Start with Standard pane:

Adjust menu:

- Adjust Menu allow you to adjust Brightness, Contrast, Focus, Position and Resolution.
- You can follow the instruction and do the adjustment.
- Cancel prompts user if you want to cancel installation.

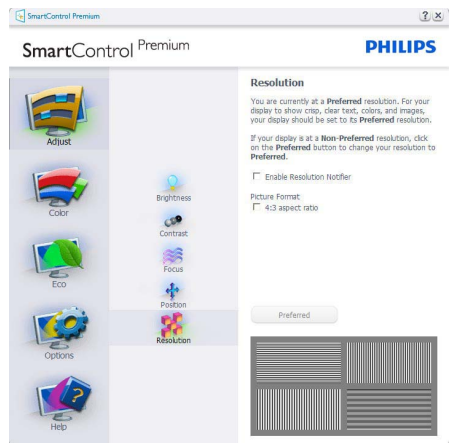
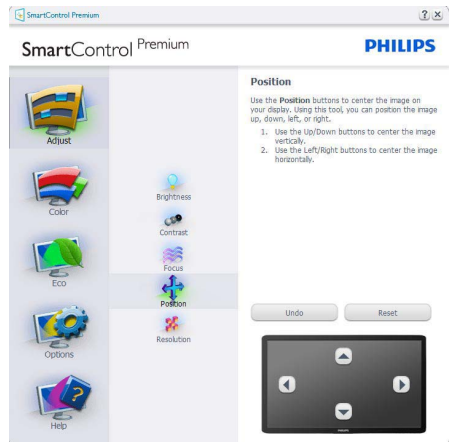
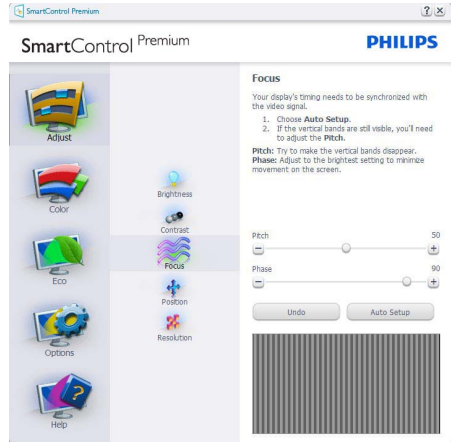
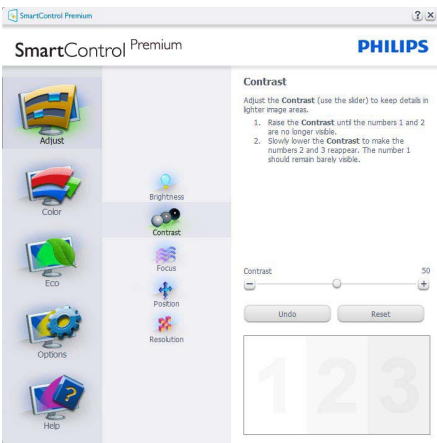
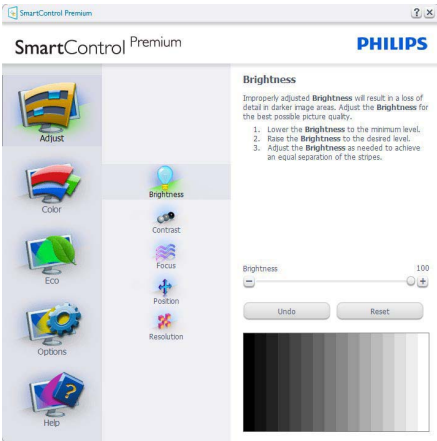

Color menu:

- Color Menu allow you to adjust RGB, Black Level, White Point, Color Calibration, and SmartImage (Please refer to SmartImage section).
- You can follow the instruction and do the adjustment.
- Refer to below table for sub-menu item base on your input.
- Example for Color Calibration

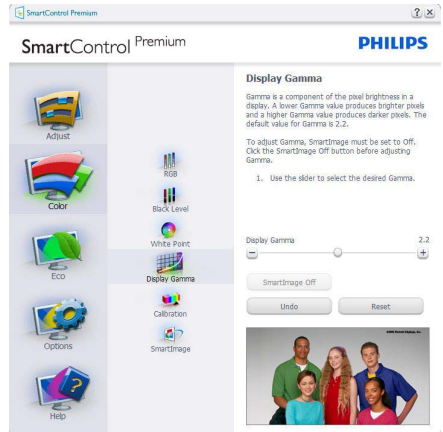
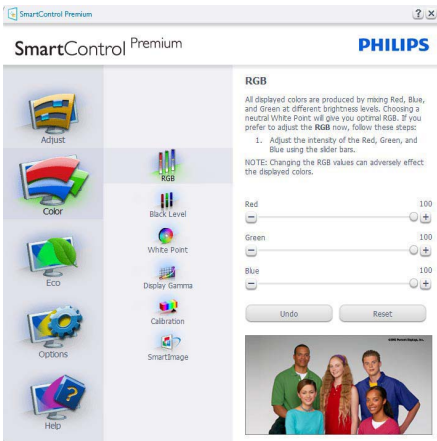

1. "Show Me" starts color calibration tutorial.
2. Start - starts the 6-step color calibration sequence.
3. QuickView loads the before/after images.
4. To return to Color home pane, click the Cancel button.
5. Enable color calibration - by default is on. If unchecked, does not allow for color calibration to happen, dims out start and quick view buttons.
6. Must have patent info in calibration screen.

First color Calibration Screen:



- Previous button is disabled until the second color screen.
- Next goes to the succeeding target (6-targets).
- Final next goes File>Presets pane.
- Cancel closes the UI and returns to the plug in page.

SmartImage

Allows user to change setting for better display setting based on content.

When Entertainment is set, SmartContrast and SmartResponse are enabled.

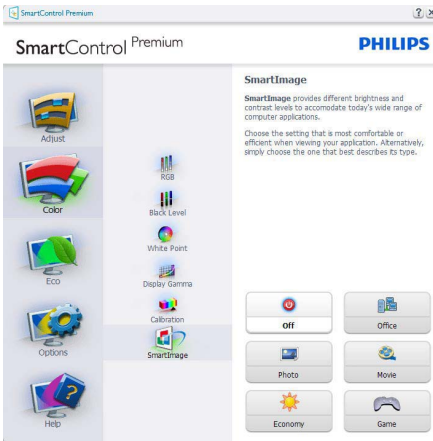

ECO

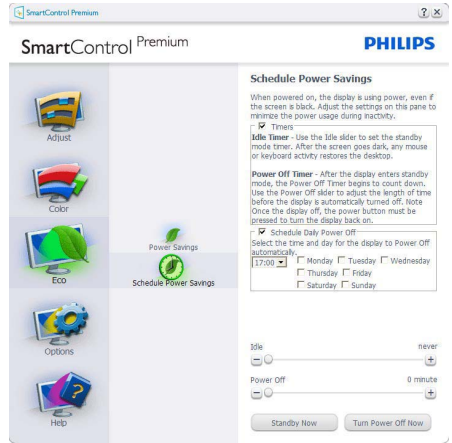

Theft Deterrence Pane will only be active when selecting Theft Deterrence Mode from the drop-down Plug Ins menu.

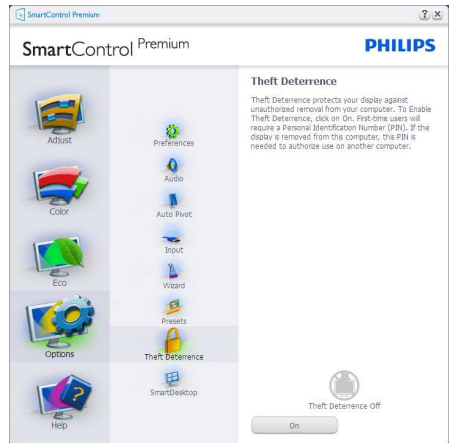

3. Image Optimization

To enable Theft Deterrence, clicking Enable Theft Deterrence Mode button brings up the following screen:

- User can enter PIN between 4 and 9 digits numbers only.
- After entering PIN, Accept button takes user to the pop-up dialog box on the following page.
- Minimum minutes set to 5. Slider set to 5 by default.
- Does not require the display be attached to a different host to go into Theft Deterrence mode.

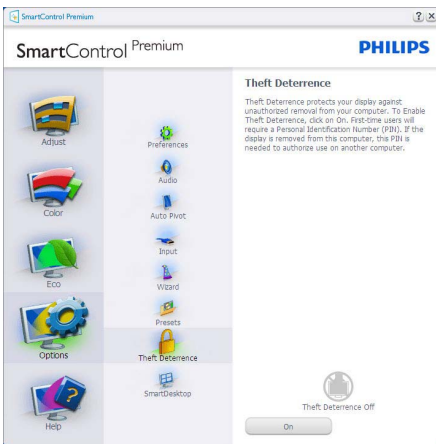

After creating PIN, the Theft Deterrence pane will indicate Theft Deterrence Enabled and provide PIN Options button:

- Theft Deterrence Enabled is displayed.
- Disable Theft Deterrence Mode opens pane screen on next page.
- PIN Options button only available after user creates PIN, button opens secure PIN web site.

Options>Preferences - Will only be active when selecting Preferences from the drop-down Options menu. On a non-supported display capable of DDC/CI, only the Help and Options tabs are available.



- Displays current preference settings.
- A checked box enables the feature. The check box is a toggle.
- Enable Context Menu on desktop is checked (On) by default. Enable Context menu displays SmartControl Premium selections for Select Preset and Tune Display in the desktop right-click context menu. Disabled removes SmartControl Premium from the right click context menu.
- Enable Task Tray icon is checked (On) by default. Enable context menu shows the task tray menu for SmartControl Premium. A right click on the task tray icon displays the menu options for Help, Technical Support. Check for Upgrade, About, and Exit. When Enable task tray menu is disabled, the task tray icon will only display EXIT.
- Run at Startup is checked (On) by default. When disabled, SmartControl Premium will not launch at start or be in the task tray. The only way to launch SmartControl Premium is either from the desktop short cut or from the program file. Any preset set to run at startup will not load when this box is unchecked (Disabled).
- Enable transparency mode (Windows 7, Vista, XP). Default is 0% Opaque.

Options>Input - Will only be active when selecting Input from the drop-down Options menu. On a non-supported display capable of DDC/CI, only the Help and Options tabs are available. All other SmartControl Premium tabs are not available.



Options>Audio - Will only be active when selecting Volume from the drop-down Options menu. On a non-supported display capable of DDC/CI, only the Help and Options tabs are available.

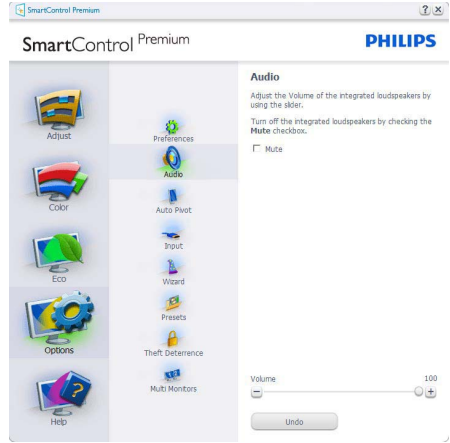

- Display the Source instruction pane and current input source setting.
- On single input displays, this pane will not be visible.

Option>Auto Pivot



Help>User Manual - Will only be active when selecting User Manual from the drop-down Help menu. On a non-supported display capable of DDC/CI, only the Help and Options tabs are available.



Help>Version - Will only be active when selecting Version from the drop-down Help menu. On a non-supported display capable of DDC/CI, only the Help and Options tabs are available.



Context Sensitive menu

The Context Sensitive menu is Enabled by default. If Enable Context Menu has been checked in the Options>Preferences pane, then the menu will be visible.



The Context Menu has four entries:

- SmartControl Premium - When selected the About Screen is displayed.
- Select Preset - Provides a hierarchical menu of saved presets for immediate use. A check mark shows the currently selected preset. Factory Preset can also be called from the drop down menu.
- Tune Display - Opens the SmartControl Premium control panel.
- SmartImage - Check current settings, Office, Photo, Movie, Game, Economy, Off.

Task Tray Menu Enabled

The task tray menu can be displayed by right-clicking on the SmartControl Premium icon from the task tray. Left Click will launch the application.



The task tray has five entries:

- Help - Access to User Manual file: Open User Manual file using the default browser window.
- Technical Support - displays the tech support page.
- Check for Update - takes the user to PDI Landing and checks the user's version against the most current available.
- About - Displays detailed reference information: product version, release information, and product name.
- Exit - Close SmartControl Premium
To run SmartControl Premium again either select SmartControl Premium from Program menu, double-click the desktop PC icon or restart the system.

Task Tray Menu Disabled

When the Task Tray is disabled in the preference folder, only the EXIT selection is available. To completely remove SmartControl Premium from the task tray, disable Run at Startup in Options>Preferences.



3.6 SmartDesktop Guide

1 SmartDesktop

SmartDesktop is in SmartControl Premium. Install SmartControl Premium and select SmartDesktop from Options.

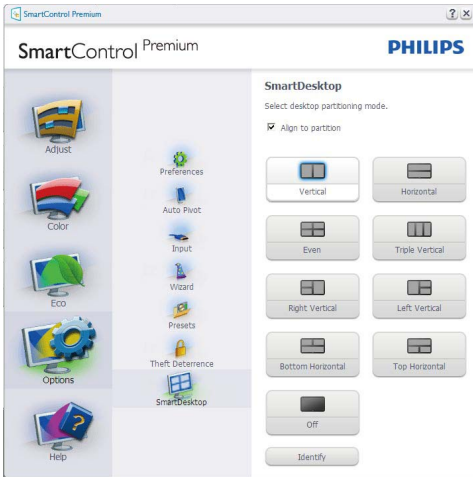

- Align to partition check box will enable automatic alignment for the window when dragged into the defined partition.
- Select the desired partition by clicking on the icon. The partition will be applied to the desktop and the icon will be highlighted.
- Identify provides a quick way to view the grid.

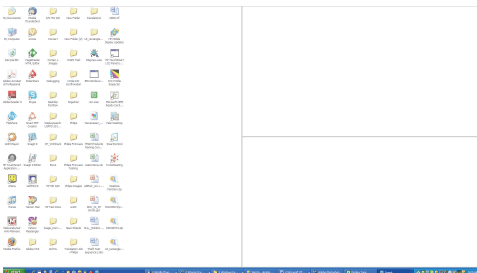

2 Drag and Drop Windows

Once the partitions are configured and Align to partition is selected a window can be dragged into the region and it will automatically align. When the window and mouse cursor are within the region, the region will become highlighted.

Note

If the outline of the region is not visible when dragging the window, "Show windows contents while dragging" is disabled. To enable:

1. In Control Panel, click System.
2. Click Advanced system settings (For Vista & Win7 OS, this is located on the left sidebar)
3. In Performance section, click Settings.
4. In the box, check Show window contents while dragging, and click OK.

Other alternative path:

Vista

Control Panel > Personalization > Window Color and Appearance > Click "Open Classic appearance properties for more color options" > Click "Effects" button > check Show window contents while dragging

XP:

Display Properties>Appearance>Effects...> check Show window contents while dragging

Win 7:

No other alternative path available.

3 Title Bar Options

Desktop partition can be accessed from the title bar of the active window. This provides a quick and easy way to manage the desktop as well as sending any window to any partition without having to drag and drop. Move the cursor into the active window's title bar to access the drop down menu.



4 Right Click Menu

Right click on the Desktop Partition icon to view the drop down menu.

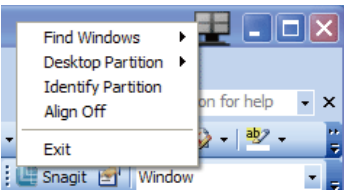

1. **Find Windows** – In some cases, the user may have sent multiple windows to the same partition. Find Window will show all open windows and move the selected window to the forefront.

2. **Desktop Partition** – Desktop Partition shows the current selected partition and allows the user to quickly change to any of the partitions shown in the drop down.

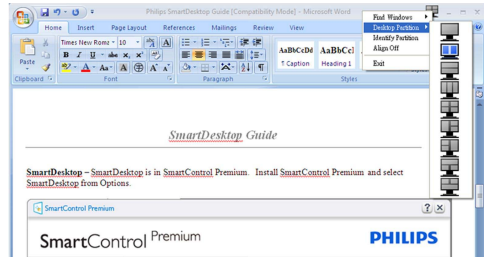

Note

If more than one display is attached, the user can select the targeted display to change the partition. The highlighted icon represents the current active partition.

3. **Identify Partition** – Displays the outline grid on the desktop for the current partition.

4. **Align On/Align Off** – Enables/disables the drag and drop auto align feature.

5. **Exit** – Closes Desktop Partition and Display Tune. To re-initialize, launch Display Tune from the start menu or short cut on the desktop.

5 Left Click Menu

Left click on the Desktop Partition icon to quickly send the active window to any partition without having to drag and drop. Releasing the mouse will send the window to the highlighted partition.

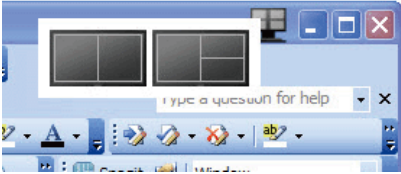





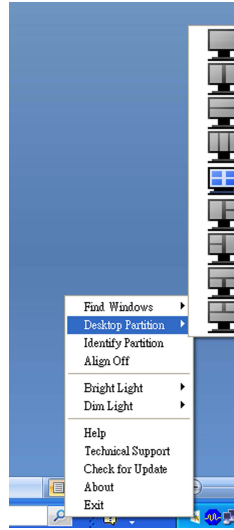

6 Task Tray Right Click

The task tray also contains most of the features supported in the title bar (with the exception of automatically sending a window to any partition).



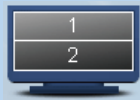

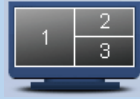

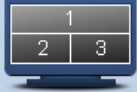
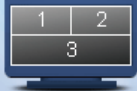
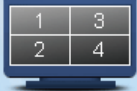

- **Find Windows** – In some cases, the user may have sent multiple windows to the same partition. Find Window will show all open windows and move the selected window to the forefront.
- **Desktop Partition** – Desktop Partition shows the current selected partition and allows the user to quickly change to any of the partitions shown in the drop down.
- **Identify Partition** – Displays the outline grid on the desktop for the current partition.
- **Align On/Align Off** – Enables/disables the drag and drop auto align feature.

7 SmartDesktop Partition Definitions

Name	Description	Image
Full Desktop	Applies all settings to the entire desktop.	
Vertical	<p>Assesses the screen resolution and divides the display into two evenly sized vertical regions.</p> <p>For 90/270 maintain vertical configuration.</p>	
Horizontal	<p>Assesses the screen resolution and divides the display into two evenly sized horizontal regions.</p> <p>For 90/270 maintain horizontal configuration.</p>	
Vertical Triple	<p>Assesses the screen resolution and divides the display into three evenly sized vertical regions.</p> <p>For 90 Partition 1 horizontal top Partition 2 horizontal center Partition 3 horizontal bottom.</p> <p>For 270 Partition 3 horizontal top Partition 2 horizontal center Partition 1 horizontal bottom.</p>	
Vertical Split Left	<p>Assesses the screen resolution and divides the display into two vertical regions, the left hand side is a single region, the right hand side is split into two evenly sized regions</p> <p>For 90 Partition 1 on top Partition 2&3 on bottom For 270 Partition 1 on bottom Partition 2&3 on top.</p>	
Vertical Split Right	<p>Assesses the screen resolution and divides the display into two vertical regions, the right hand side is a single region, the left hand side is split into two evenly sized regions</p> <p>For 90 Partition 1&2 on top Partition 3 on bottom. For 270 Partition 3 on top Partition 1&2 on bottom.</p>	

Name	Description	Image
Horizontal Split Top	<p>Assesses the screen resolution and divides the display into two evenly sized horizontal regions, the top region is single, the bottom region is split into two evenly sized regions</p> <p>For 90 Partition 1 on right side Vertical Partition 2&3 on left side Vertical. For 270 Partition 1 on left side Vertical Partition 2&3 on right side Vertical.</p>	
Horizontal Split Bottom	<p>Assesses the screen resolution and divides the display into two evenly sized horizontal regions, the bottom region is single, the top region is split into two evenly sized regions</p> <p>For 90 Partition 1&2 on right side Vertical Partition 3 on left side Vertical. For 270 Partition 1&2 on left side Vertical Partition 3 on right side Vertical.</p>	
Even Split	<p>Assesses the screen resolution and divides the display into four evenly sized regions.</p>	

4 Technical Specifications

Picture/Display	
Monitor panel type	TFT-LCD
Backlight	CCFL (241P3/241P3Y), LED (241P3L/241P3LY)
Panel size	24" W (61.0 cm)
Aspect ratio	16:9
Pixel Pitch	0.277 x 0.277 mm
Brightness	300 cd/m ² (241P3/241P3Y); 250 cd/m ² (241P3L/241P3LY)
SmartContrast	500,000:1 (241P3/241P3Y); 20,000,000:1 (241P3L/241P3LY)
Contrast ratio (typical)	1000:1
Response time (typical)	5 ms
Optimum Resolution	1920 x 1080 @ 60Hz
Viewing angle	170° (H) / 160° (V) @ C/R > 10
Picture Enhancement	SmartImage
Display colors	16.7 M
Vertical refresh rate	56Hz -76Hz
Horizontal Frequency	30kHz - 83kHz
sRGB	YES
Connectivity	
Signal input (241P3, 241P3L)	DVI-D (Digital),VGA (Analog)
Signal input (241P3Y, 241P3LY)	DVI-D (Digital),VGA (Analog), Display port
USB	USB 2.0 x 1
Input Signal	Separate Sync, Sync on Green
Audio In/Out	Stereo Audio
Convenience	
Build-in Audio	1.5W x 2
User Convenience	     
OSD Languages	English, French, German, Italian, Russian, Spanish, Simplified Chinese, Portuguese
Other convenience	VESA mount (100 x 100mm), Kensington lock
Plug & Play Compatibility	DDC/CI, sRGB, Windows 7/Vista/XP, Mac OSX, Linux
Stand	
Tilt	-5/+20
Swivel	-65/+65
Height adjustment	130mm

Power (241P3)			
On mode	40.6W (typ.), 46W(max.) (with audio and USB x 1)		
On mode (ECO mode) (typical)	21W		
Energy Consumption (EnergyStar 5.0 test method)	AC Input Voltage at 100VAC +/-5VAC, 50Hz +/- 3Hz	AC Input Voltage at 115VAC +/-5VAC, 60Hz +/- 3Hz	AC Input Voltage at 230VAC +/-5VAC, 50Hz +/- -3Hz
Normal Operation (typical)	28W	27.45W	27.37W
Sleep (typical)	0.1W	0.1W	0.1W
Off	0.1W	0.1W	0.1W
Heat Dissipation*	AC Input Voltage at 100VAC +/-5VAC, 50Hz +/- -3Hz	AC Input Voltage at 115VAC +/-5VAC, 60Hz +/- -3Hz	AC Input Voltage at 230VAC +/-5VAC, 50Hz +/- -3Hz
Normal Operation	95.56BTU	93.69BTU	93.40BTU
Sleep (typical)	0.34BTU	0.34BTU	0.34BTU
Off	0.34BTU	0.34BTU	0.34BTU
Power (241P3L)			
On mode	24.5W (typ.), 35W(max) (with audio and USB x 1)		
On mode (ECO mode) (typical)	12W		
Energy Consumption (EnergyStar 5.0 test method)	AC Input Voltage at 100VAC +/-5VAC, 50Hz +/- 3Hz	AC Input Voltage at 115VAC +/-5VAC, 60Hz +/- 3Hz	AC Input Voltage at 230VAC +/-5VAC, 50Hz +/- -3Hz
Normal Operation (typical)	19.04W	18.9W	18.96W
Sleep (typical)	0.1W	0.1W	0.1W
Off	0.1W	0.1W	0.1W
Heat Dissipation*	AC Input Voltage at 100VAC +/-5VAC, 50Hz +/- -3Hz	AC Input Voltage at 115VAC +/-5VAC, 60Hz +/- -3Hz	AC Input Voltage at 230VAC +/-5VAC, 50Hz +/- -3Hz
Normal Operation	64.97BTU	64.47BTU	64.7BTU
Sleep (typical)	0.34BTU	0.34BTU	0.34BTU
Off	0.34BTU	0.34BTU	0.34BTU
Power (241P3Y)			
On mode	42W (typ.), 47W(max.) (with audio and USB x 1)		
On mode (ECO mode) (typical)	23W		
Energy Consumption (EnergyStar 5.0 test method)	AC Input Voltage at 100VAC +/-5VAC, 50Hz +/- 3Hz	AC Input Voltage at 115VAC +/-5VAC, 60Hz +/- 3Hz	AC Input Voltage at 230VAC +/-5VAC, 50Hz +/- -3Hz
Normal Operation (typical)	29.22W	29W	29.55W
Sleep (typical)	0.5W	0.5W	0.5W
Off	0.3W	0.3W	0.3W
Heat Dissipation*	AC Input Voltage at 100VAC +/-5VAC, 50Hz +/- -3Hz	AC Input Voltage at 115VAC +/-5VAC, 60Hz +/- -3Hz	AC Input Voltage at 230VAC +/-5VAC, 50Hz +/- -3Hz
Normal Operation	99.71BTU	99.22BTU	100.8BTU
Sleep (typical)	1.706BTU	1.706BTU	1.706BTU
Off	1.024BTU	1.024BTU	1.024BTU

Power (241P3LY)			
On mode	26W (typ.), 36W(max) (with audio and USB x 1)		
On mode (ECO mode) (typical)	14W		
Energy Consumption (EnergyStar 5.0 test method)	AC Input Voltage at 100VAC +/-5VAC, 50Hz +/- 3Hz	AC Input Voltage at 115VAC +/-5VAC, 60Hz +/- 3Hz	AC Input Voltage at 230VAC +/-5VAC, 50Hz +/- -3Hz
Normal Operation (typical)	19.32W	19.16W	18.9W
Sleep (typical)	0.5W	0.5W	0.5W
Off	0.3W	0.3W	0.3W
Heat Dissipation*	AC Input Voltage at 100VAC +/-5VAC, 50Hz +/- -3Hz	AC Input Voltage at 115VAC +/-5VAC, 60Hz +/- -3Hz	AC Input Voltage at 230VAC +/-5VAC, 50Hz +/- -3Hz
Normal Operation	65.94BTU	65.38BTU	61.51BTU
Sleep (typical)	1.71BTU	1.71BTU	1.71BTU
Off	1.024BTU	1.024BTU	1.024BTU
Power LED indicator			
Power LED indicator	On mode: White, Standby/Sleep mode: White (blinking)		
Power Supply			
Power Supply	Build-in, 100-240VAC, 50/60Hz		
Dimension			
Product with stand (WxHxD)	570 x 507 x 220mm		
Product without stand (WxHxD)	570 x 353 x 62mm		
Box dimension (WxHxD)	670 x 268 x 413mm		
Weight			
Product with stand	6.6kg (241P3/241P3Y), 6.0kg (241P3L/241P3LY)		
Product without stand	4.4kg (241P3/241P3Y), 3.8kg (241P3L/241P3LY)		
Product with packaging	9.3kg (241P3/241P3Y), 8.7kg (241P3L/241P3LY)		
Operating Condition			
Temperature range	Storage: -20°C to 60°C		
	operation: 0°C to 40 °C		
Relative humidity	20% to 80%		
Altitude	Non-operation: + 40,000 ft (12,192 m)		
	operation: + 12,000 ft (3,658 m)		
MTBF	50,000 hrs (241P3/241P3Y), 30,000 hrs (241P3L/241P3LY)		

Environmental	
ROHS	YES
EPEAT	Gold. (www.epeat.net)
Packaging	100% recyclable
Compliance and standards	
Regulatory Approvals	BSMI, CE Mark, FCC Class B, GOST, SEMKO, TCO5.1, UL/cUL,, ISO9241-307, TUV-GS, TUV-Ergo
Cabinet	
Color	Black/Silver
Finish	Texture

 **Note**

1. EPEAT Gold or Silver is valid only where Philips registers the product. Please visit www.epeat.net for registration status in your country.
2. This data is subject to change without notice. Go to www.philips.com/support to download the latest version of leaflet.

4.1 Resolution & Preset Modes

1 Maximum Resolution

For 241P3/241P3L/241P3Y/241P3LY
 1920 x 1080 at 60 Hz (analog input)
 1920 x 1080 at 60 Hz (digital input)

2 Recommended Resolution

For 241P3/241P3L/241P3Y/241P3LY
 1920 x 1080 at 60 Hz (digital input)

H. freq (kHz)	Resolution	V. freq (Hz)
31.47	640x480	59.94
37.88	800x600	60.32
48.36	1024x768	60.00
54.00	1152x864	60.00
44.77	1280x720	59.86
47.78	1280x768	59.87
49.70	1280x800	59.81
60.00	1280x960	60.00
63.89	1280x1024	60.02
47.71	1360x768	60.02
55.47	1440x900	59.90
55.94	1440x900	59.89
75.00	1600x1200	60.00
64.67	1680x1050	59.88
65.29	1680x1050	59.95
66.59	1920x1080	59.93
74.04	1920x1200	59.95
67.50	1920x1080	60.00

Note

Please notice that your display works best at native resolution of 1920 X 1080@60Hz. For best display quality, please follow this resolution recommendation.

5. Power Management

5.1 Automatic PowerSaving

If you have VESA DPM compliance display card or software installed in your PC, the monitor can automatically reduce its power consumption when not in use. If an input from a keyboard, mouse or other input device is detected, the monitor will 'wake up' automatically. The following table shows the power consumption and signaling of this automatic power saving feature:

Power Management Definition (241P3)					
VESA Mode	Video	H-sync	V-sync	Power Used	LED color
Active	ON	Yes	Yes	40.6W (typ.), 46W (max.) (with audio and USB x 1)	White
Sleep (typ.)	OFF	No	No	0.1W	White (Blinking)
Switch Off	OFF	-	-	0.1W	OFF

Power Management Definition (241P3L)					
VESA Mode	Video	H-sync	V-sync	Power Used	LED color
Active	ON	Yes	Yes	24.5W (typ.), 35W (max.) (with audio and USB x 1)	White
Sleep (typ.)	OFF	No	No	0.1W	White (Blinking)
Switch Off	OFF	-	-	0.1W	OFF

Power Management Definition (241P3Y)					
VESA Mode	Video	H-sync	V-sync	Power Used	LED color
Active	ON	Yes	Yes	42.W (typ.), 47W (max.) (with audio and USB x 1)	White
Sleep (typ.)	OFF	No	No	0.5W	White (Blinking)
Switch Off	OFF	-	-	0.3W	OFF

Power Management Definition (241P3LY)					
VESA Mode	Video	H-sync	V-sync	Power Used	LED color
Active	ON	Yes	Yes	26W (typ.), 36W (max.) (with audio and USB x 1)	White
Sleep (typ.)	OFF	No	No	0.5W	White (Blinking)
Switch Off	OFF	-	-	0.3W	OFF

The following setup is used to measure power consumption on this monitor:

Native resolution: 1920x1080.

Contrast: 50%

Brightness: 300 nits (241P3/241P3Y); 250 nits (241P3L/241P3LY)

Color temperature: 6500k with full white pattern

Audio and USB Inactive (Off)

Note

This data is subject to change without notice.

6 Regulatory Information

Lead-free Product



Lead free display promotes environmentally sound recovery and disposal of waste from electrical and electronic equipment. Toxic substances

like Lead has been eliminated and compliance with European community's stringent RoHs directive mandating restrictions on hazardous substances in electrical and electronic equipment have been adhered to in order to make Philips monitors safe to use throughout its life cycle.

TCO Displays 5.1 Information



**Congratulations,
Your display is designed for both
you and the planet!**

The display you have just purchased carries the TCO Certified label. This ensures that your display is designed, manufactured and tested according to some of the strictest quality and environmental requirements in the world. This makes for a high performance product, designed with the user in focus that also minimizes the impact on the climate and our natural environment. TCO Certified is a third party verified program, where every product model is tested by an accredited impartial test laboratory. TCO Certified represents one of the toughest certifications for displays worldwide.

Some of the Usability features of the TCO Certified for displays:

- Visual ergonomics for good image quality is tested to ensure top performance and reduce sight and strain problems. Important parameters are luminance, contrast, resolution, black level, gamma curve, colour and luminance uniformity and colour rendering

- Products are tested according to rigorous safety standards at impartial laboratories
- Electric and magnetic fields emissions as low as normal household background levels
- Low acoustic noise emissions (when applicable)

Some of the Environmental features of the TCO Certified for displays:

- The brand owner demonstrates corporate social responsibility and has a certified environmental management system (EMAS or ISO 14001)
- Very low energy consumption both in on- and standby mode minimize climate impact
- Restrictions on chlorinated and brominated flame retardants, plasticizers, plastics and heavy metals such as cadmium, mercury and lead (RoHS compliance)
- Both product and product packaging is prepared for recycling
- The brand owner offers take-back options

The requirements can be downloaded from our web site. The requirements included in this label have been developed by TCO Development in co-operation with scientists, experts, users as well as manufacturers all over the world. Since the end of the 1980s TCO has been involved in influencing the development of IT equipment in a more user-friendly direction. Our labeling system started with displays in 1992 and is now requested by users and IT manufacturers all over the world. About 50% of all displays worldwide are TCO certified.

For more information, please visit
www.tcodevelopment.com

EPEAT

(www.epeat.net)



"The EPEAT (Electronic Product Environmental Assessment Tool) program evaluates computer desktops, laptops, and monitors based on 51 environmental criteria

developed through an extensive stakeholder consensus process supported by US EPA. EPEAT system helps purchasers in the public and private sectors evaluate, compare and select desktop computers, notebooks and monitors based on their environmental attributes. EPEAT also provides a clear and consistent set of performance criteria for the design of products, and provides an opportunity for manufacturers to secure market recognition for efforts to reduce the environmental impact of its products."

Benefits of EPEAT

Reduce use of primary materials

Reduce use of toxic materials

Avoid the disposal of hazardous waste EPEAT'S requirement that all registered products meet ENERGY STAR's energy efficiency specifications, means that these products will consume less energy throughout their life.

CE Declaration of Conformity

This product is in conformity with the following standards

- EN60950-1:2006 (Safety requirement of Information Technology Equipment)
- EN55022:2006 (Radio Disturbance requirement of Information Technology Equipment)
- EN55024:1998+A1:2001+A2:2003 (Immunity requirement of Information Technology Equipment)
- EN61000-3-2:2006 (Limits for Harmonic Current Emission)
- EN61000-3-3:1995+A1:2001+A2:2005 (Limitation of Voltage Fluctuation and Flicker) following provisions of directives applicable
- 2006/95/EC (Low Voltage Directive)
- 2004/108/EC (EMC Directive)

- 2005/32/EC (EuP Directive, EC No. 1275/2008 implementing Directive for Standby and Off mode power consumption) and is produced by a manufacturing organization on ISO9000 level.

The product also comply with the following standards

- ISO9241-307:2008 (Ergonomic requirement, Analysis and compliance test methods for electronic visual displays)
- GS EK1-2000:2009 (GS mark requirement)
- prEN50279:1998 (Low Frequency Electric and Magnetic fields for Visual Display)
- MPR-II (MPR:1990:8/1990:10 Low Frequency Electric and Magnetic fields)
- TCO Displays 5.1 (Requirement for Environment Labeling of Ergonomics, Energy, Ecology and Emission, TCO: Swedish Confederation of Professional Employees) for TCO versions

Energy Star Declaration

(www.energystar.gov)



As an ENERGY STAR® Partner, we have determined that this product meets the ENERGY STAR® guidelines for energy efficiency.

Note

We recommend you switch off the monitor when it is not in use for a long time.

Federal Communications Commission (FCC) Notice (U.S. Only)

 This equipment has been tested and found to comply with the limits for a Class B digital device, pursuant to Part 15 of the FCC Rules. These limits are designed to provide reasonable protection against harmful interference in a residential installation. This equipment generates, uses and can radiate radio frequency energy and, if not installed and used in accordance with the instructions, may cause harmful interference to radio communications. However, there is no guarantee that interference will not occur in a particular installation. If this equipment does cause harmful interference to radio or television reception, which can be determined by turning the equipment off and on, the user is encouraged to try to correct the interference by one or more of the following measures:

- Reorient or relocate the receiving antenna.
- Increase the separation between the equipment and receiver.
- Connect the equipment into an outlet on a circuit different from that to which the receiver is connected.
- Consult the dealer or an experienced radio/TV technician for help.

 Changes or modifications not expressly approved by the party responsible for compliance could void the user's authority to operate the equipment.

Use only RF shielded cable that was supplied with the monitor when connecting this monitor to a computer device.

To prevent damage which may result in fire or shock hazard, do not expose this appliance to rain or excessive moisture.

THIS CLASS B DIGITAL APPARATUS MEETS ALL REQUIREMENTS OF THE CANADIAN INTERFERENCE-CAUSING EQUIPMENT REGULATIONS.

FCC Declaration of Conformity

Declaration of Conformity for Products Marked with FCC Logo,

United States Only



This device complies with Part 15 of the FCC Rules. Operation is subject to the following two conditions: (1) this device may not cause harmful interference, and (2) this device must accept any interference received, including interference that may cause undesired operation.

Commission Federale de la Communication (FCC Declaration)

 Cet équipement a été testé et déclaré conforme aux limites des appareils numériques de class B, aux termes de l'article 15 Des règles de la FCC. Ces limites sont conçues de façon à fournir une protection raisonnable contre les interférences nuisibles dans le cadre d'une installation résidentielle.

CET appareil produit, utilise et peut émettre des hyperfréquences qui, si l'appareil n'est pas installé et utilisé selon les consignes données, peuvent causer des interférences nuisibles aux communications radio.

Cependant, rien ne peut garantir l'absence d'interférences dans le cadre d'une installation particulière. Si cet appareil est la cause d'interférences nuisibles pour la réception des signaux de radio ou de télévision, ce qui peut être décelé en fermant l'équipement, puis en le remettant en fonction, l'utilisateur pourrait essayer de corriger la situation en prenant les mesures suivantes:

- Réorienter ou déplacer l'antenne de réception.
- Augmenter la distance entre l'équipement et le récepteur.
- Brancher l'équipement sur un autre circuit que celui utilisé par le récepteur.
- Demander l'aide du marchand ou d'un technicien chevronné en radio/télévision.

 Toutes modifications n'ayant pas reçu l'approbation des services compétents en matière de conformité est susceptible d'interdire à l'utilisateur l'usage du présent équipement.

N'utiliser que des câbles RF armés pour les connections avec des ordinateurs ou périphériques.

CET APPAREIL NUMERIQUE DE LA CLASSE B RESPECTE TOUTES LES EXIGENCES DU REGLEMENT SUR LE MATERIEL BROUILLEUR DU CANADA.

EN 55022 Compliance (Czech Republic Only)

This device belongs to category B devices as described in EN 55022, unless it is specifically stated that it is a Class A device on the specification label. The following applies to devices in Class A of EN 55022 (radius of protection up to 30 meters). The user of the device is obliged to take all steps necessary to remove sources of interference to telecommunication or other devices.

Pokud není na typovém štítku počítače uvedeno, že spadá do do třídy A podle EN 55022, spadá automaticky do třídy B podle EN 55022. Pro zařízení zařazená do třídy A (chranné pásmo 30m) podle EN 55022 platí následující. Dojde-li k rušení telekomunikačních nebo jiných zařízení je uživatel povinen provést taková opatření, aby rušení odstranil.

Polish Center for Testing and Certification Notice

The equipment should draw power from a socket with an attached protection circuit (a three-prong socket). All equipment that works together (computer; monitor; printer; and so on) should have the same power supply source.

The phasing conductor of the room's electrical installation should have a reserve short-circuit protection device in the form of a fuse with a nominal value no larger than 16 amperes (A).

To completely switch off the equipment, the power supply cable must be removed from the power supply socket, which should be located near the equipment and easily accessible.

A protection mark "B" confirms that the equipment is in compliance with the protection usage requirements of standards PN-93/T-42107 and PN-89/E-06251.

Wymagania Polskiego Centrum Badań i Certyfikacji

Urządzenie powinno być zasilane z gniazda z przyłączonym obwodem ochronnym (gniazdo z kołkiem). Współpracujące ze sobą urządzenia (komputer, monitor, drukarka) powinny być zasilane z tego samego źródła.

Instalacja elektryczna pomieszczenia powinna zawierać w przewodzie fazowym rezerwową ochronę przed zwarciami, w postaci bezpiecznika o wartości znamionowej nie większej niż 16A (amperów).

W celu całkowitego wyłączenia urządzenia z sieci zasilania, należy wyjąć wtyczkę kabla zasilającego z gniazda, które powinno znajdować się w pobliżu urządzenia i być łatwo dostępne.

Znak bezpieczeństwa "B" potwierdza zgodność urządzenia z wymaganiami bezpieczeństwa użytkowania zawartymi w PN-93/T-42107 i PN-89/E-06251.

Pozostałe instrukcje bezpieczeństwa

- Nie należy używać wtyczek adapterowych lub usuwać końka obwodu ochronnego z wtyczki. Jeżeli konieczne jest użycie przedłużacza to należy użyć przedłużacza 3-żyłowego z prawidłowo połączonym przewodem ochronnym.
- System komputerowy należy zabezpieczyć przed nagłymi, chwilowymi wzrostami lub spadkami napięcia, używając eliminatora przepięć, urządzenia depasującego lub bezzakłócenowego źródła zasilania.
- Należy upewnić się, aby nic nie leżało na kablach systemu komputerowego, oraz aby kable nie były umieszczone w miejscu, gdzie można byłoby na nie nadeptywać lub potykać się o nie.
- Nie należy rozlewać napojów ani innych płynów na system komputerowy.
- Nie należy wyciągać żadnych przedmiotów do otworów systemu komputerowego, gdyż może to spowodować pożar lub porażenie prądem, poprzez zwarcie elementów wewnętrznych.
- System komputerowy powinien znajdować się z dala od grzejników i źródeł ciepła. Ponadto, nie należy blokować otworów wentylacyjnych. Należy unikać kładzenia luznych papierów pod komputer oraz umieszczania komputera w ciasnym miejscu bez możliwości cyrkulacji powietrza wokół niego.

North Europe (Nordic Countries) Information

Placering/Ventilation VARNING: FÖRSÄKRA DIG OM ATT HUVUDBRYTARE OCH UTTAG ÄR LÅTÅTKOMLIGA, NÄR DU STÄLLER DIN UTRUSTNING PÅPLATS.
Placering/Ventilation ADVARSEL: SØRG VED PLACERINGEN FOR, AT NETLEDNINGENS STIK OG STIKKONTAKT ER NEMT TILGÆNGELIGE.
Paikka/Ilmankierto VAROITUS: SIIJOITA LAITE SITEN, ETTÄ VERKKOJOHTO VOIDAAN TARVITTAESSA HELPOSTI IRROTTAA PISTORASIASTA.
Plassering/Ventilasjon ADVARSEL: NÅR DETTE UTSTYRET PLASSERES, MÅ DU PASSE PÅ AT KONTAKTENE FOR STØMTILFØRSEL ER LETTE Å NÅ.

BSMI Notice (Taiwan Only)

符合乙類資訊產品之標準

Ergonomie Hinweis (nur Deutschland)

Der von uns gelieferte Farbmonitor entspricht den in der "Verordnung über den Schutz vor Schäden durch Röntgenstrahlen" festgelegten Vorschriften.

Auf der Rückwand des Gerätes befindet sich ein Aufkleber, der auf die Unbedenklichkeit der Inbetriebnahme hinweist, da die Vorschriften über die Bauart von Störstrahlern nach Anlage III α 5 Abs. 4 der Röntgenverordnung erfüllt sind.

Damit Ihr Monitor immer den in der Zulassung geforderten Werten entspricht, ist darauf zu achten, daß

1. Reparaturen nur durch Fachpersonal durchgeführt werden.
2. nur original-Ersatzteile verwendet werden.
3. bei Ersatz der Bildröhre nur eine bauartgleiche eingebaut wird.

Aus ergonomischen Gründen wird empfohlen, die Grundfarben Blau und Rot nicht auf dunklem Untergrund zu verwenden (schlechte Lesbarkeit und erhöhte Augenbelastung bei zu geringem Zeichenkontrast wären die Folge).

Der arbeitsplatzbezogene Schalldruckpegel nach DIN 45 635 beträgt 70dB (A) oder weniger.

ACHTUNG: BEIM AUFSTELLEN DIESES GERÄTES DARAUFGAHTEN, DAß NETZSTECKER UND NETZKABELANSCHLÜßE LEICHT ZUGÄNGLICH SIND.

China RoHS

The People's Republic of China released a regulation called "Management Methods for Controlling Pollution by Electronic Information Products" or commonly referred to as China RoHS. All products are produced and sold for China market have to meet China RoHS request.

中国大陆RoHS

根据中国大陆《电子信息产品污染控制管理办法》(也称为中国大陆RoHS), 以下部分列出了本产品中可能包含的有毒有害物质或元素名称和含量

本表适用之产品

显示器(液晶及CRT)

有毒有害物质或元素

部件名称	有毒有害物质或元素					
	铅 (Pb)	汞 (Hg)	镉 (Cd)	六价铬 (Cr6+)	多溴联苯 (PBB)	多溴二苯醚 (PBDE)
外壳	○	○	○	○	○	○
CRT显示屏	×	○	○	○	○	○
液晶显示屏/灯管	×	×	○	○	○	○
电路板组件*	×	○	○	○	○	○
电源适配器	×	○	○	○	○	○
电源线/连接线	×	○	○	○	○	○

*: 电路板组件包括印刷电路板及其构成的零部件, 如电阻、电容、集成电路、连接器等
 ○: 表示该有毒有害物质在该部件所有均质材料中的含量均在《电子信息产品中有毒有害物质的限量要求标准》规定的限量要求以下
 ×: 表示该有毒有害物质至少在该部件的某一均质材料中的含量超出《电子信息产品中有毒有害物质的限量要求标准》规定的限量要求; 但是上表中打“×”的部件, 符合欧盟RoHS法规要求(属于豁免的部分)



环保使用期限

此标识指期限(十年), 电子信息产品中含有的有毒有害物质或元素在正常使用的条件下不会发生外泄或突变, 电子信息产品用户使用该电子信息产品不会对环境造成严重污染或对其人身、财产造成严重损害的期限。

中国能源效率标识

根据中国大陆《能源效率标识管理办法》本显示器符合以下要求:

能源效率(cd/W)	> 1.05
能效等级	1级
能效标准	GB 21520-2008

详细有关信息请查阅中国能效标识网: <http://www.energylabel.gov.cn/>

7 Customer care and warranty

7.1 Philips' Flat Panel Monitors Pixel Defect Policy

Philips strives to deliver the highest quality products. We use some of the industry's most advanced manufacturing processes and practice stringent quality control. However, pixel or sub pixel defects on the TFT monitor panels used in flat panel monitors are sometimes unavoidable. No manufacturer can guarantee that all panels will be free from pixel defects, but Philips guarantees that any monitor with an unacceptable number of defects will be repaired or replaced under warranty. This notice explains the different types of pixel defects and defines acceptable defect levels for each type. In order to qualify for repair or replacement under warranty, the number of pixel defects on a TFT monitor panel must exceed these acceptable levels. For example, no more than 0.0004% of the sub pixels on a 19" XGA monitor may be defective. Furthermore, Philips sets even higher quality standards for certain types or combinations of pixel defects that are more noticeable than others. This policy is valid worldwide.

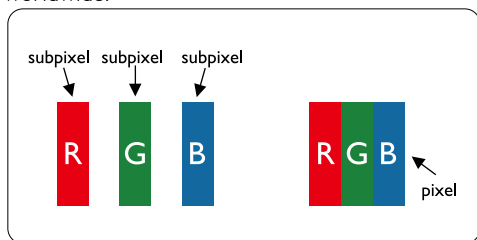

Pixels and Sub pixels

A pixel, or picture element, is composed of three sub pixels in the primary colors of red, green and blue. Many pixels together form an image. When all sub pixels of a pixel are lit, the three colored sub pixels together appear as a single white pixel. When all are dark, the three colored sub pixels together appear as a single black pixel. Other combinations of lit and dark sub pixels appear as single pixels of other colors.

Types of Pixel Defects

Pixel and sub pixel defects appear on the screen in different ways. There are two categories of pixel defects and several types of sub pixel defects within each category.

Bright Dot Defects

Bright dot defects appear as pixels or sub pixels that are always lit or 'on'. That is, a bright dot is a sub-pixel that stands out on the screen when the monitor displays a dark pattern. There are the types of bright dot defects:

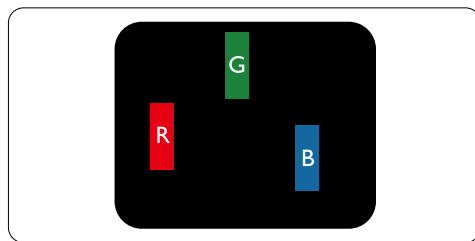

One lit red, green or blue sub pixel

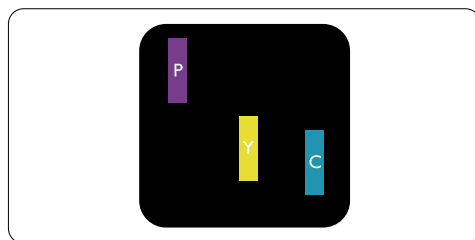

Two adjacent lit sub pixels:

- Red + Blue = Purple
- Red + Green = Yellow
- Green + Blue = Cyan (Light Blue)

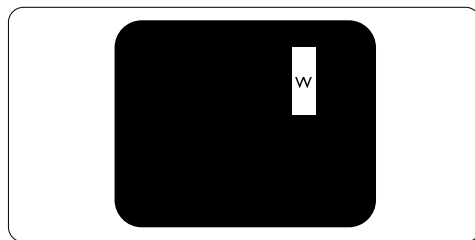

Three adjacent lit sub pixels (one white pixel)

Note

A red or blue bright dot must be more than 50 percent brighter than neighboring dots while a green bright dot is 30 percent brighter than neighboring dots.

Black Dot Defects

Black dot defects appear as pixels or sub pixels that are always dark or 'off'. That is, a dark dot is a sub-pixel that stands out on the screen when the monitor displays a light pattern. These are the types of black dot defects.

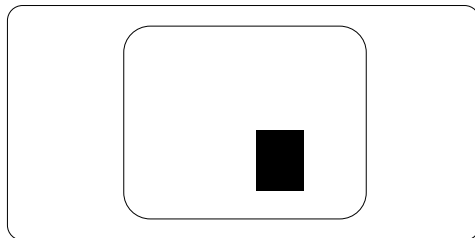
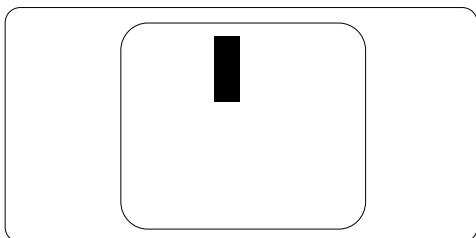
**Proximity of Pixel Defects**

Because pixel and sub pixels defects of the same type that are near to one another may be more noticeable, Philips also specifies tolerances for the proximity of pixel defects.

Pixel Defect Tolerances

In order to qualify for repair or replacement due to pixel defects during the warranty period, a TFT monitor panel in a Philips flat panel monitor must have pixel or sub pixel defects exceeding the tolerances listed in the following tables.

BRIGHT DOT DEFECTS	ACCEPTABLE LEVEL
1 lit subpixel	3
2 adjacent lit subpixels	1
3 adjacent lit subpixels (one white pixel)	0
Distance between two bright dot defects*	>15mm
Total bright dot defects of all types	3

BLACK DOT DEFECTS	ACCEPTABLE LEVEL
1 dark subpixel	5 or fewer
2 adjacent dark subpixels	2 or fewer
3 adjacent dark subpixels	0
Distance between two black dot defects*	>15mm
Total black dot defects of all types	5 or fewer

TOTAL DOT DEFECTS	ACCEPTABLE LEVEL
Total bright or black dot defects of all types	5 or fewer

Note

1 or 2 adjacent sub pixel defects = 1 dot defect

This monitor is ISO9241-307 compliant. (ISO9241-307: Ergonomic requirement, analysis and compliance test methods for electronic visual displays)

7.2 Customer Care & Warranty

Customer Care & Warranty

PLEASE SELECT YOUR COUNTRY/AREA TO REVIEW DETAILS OF YOUR WARRANTY COVERAGE

WESTERN EUROPE

Austria / Belgium / Denmark / France / Germany / Greece / Finland / Ireland / Italy / Luxembourg / the Netherlands / Norway / Portugal / Sweden / Switzerland / Spain / United Kingdom / Poland

CENTRAL AND EASTERN EUROPE region

Czech Republic / Hungary / Russia / Slovakia / Slovenia / Turkey/ Romania/ Bulgaria/ Ukraine/ Baltic's/Belarus/ Croatia/ Estonia/ Latvia/ Lithuania/ Serbia & Montenegro

LATIN AMERICA

Argentina / Brasil

NORTH AMERICA

Canada / USA

PACIFIC

Australia / New Zealand

ASIA

China / Hong Kong / Macau/ India / Indonesia / Korea / Malaysia / Pakistan / Philippines / Singapore / Taiwan / Thailand / Vietnam

AFRICA

South Africa

MIDDLE EAST

United Arab Emirates/ Israel

Your Philips Warranty conditions for Western Europe per 1st of January 2011



Dear Customer,

Thank you for purchasing this Philips monitor:

All Philips monitors are designed and manufactured to high standards and deliver high-quality performance, ease of use and ease of installation. Should you encounter any difficulties while installing or using this product, please contact the Philips helpdesk directly to benefit from your Philips Warranty conditions. This service warranty entitles you to get a solution depending on the model you purchased when your monitor turns out to be faulty or defective.

What is covered?

The Philips West European Warranty applies within Andorra, Austria, Belgium, Cyprus, Denmark, France, Germany, Greece, Finland, Ireland, Italy, Liechtenstein, Luxembourg, Monaco, the Netherlands, Norway, Poland, Portugal, Sweden, Switzerland, Spain and the United Kingdom and only for monitors originally designed, manufactured, approved and/or authorized for usage within these countries.

Warranty coverage begins as from the day you buy your monitor and be serviced in case of defects provided for under the warranty coverage for a warranty period of 24 months for Philips C, E,T,V, and X models and for models B, P and S we give 36 months. Your original purchase document is your proof for the purchase day, so keep this carefully stored and available when a warranty service is requested.

For the C,E,T,V and X models, your monitor will be picked-up at your address, repaired in our Certified Service Center and Return back to your address within 7 working days after it's picked up. If no Repair can be fulfilled within 10 working days after the unit is picked up then a replacement monitor of at least an equivalent monitor will be shipped to you.

The swap monitor remains yours and Philips keeps the defective/original monitor. For the swap monitor the warranty period remains equal to that of your original monitor, being 24 months as from the purchase date of your original monitor.

For the B, P and S models, your monitor will be swapped by at least an equivalent monitor in case of defects provided for under the warranty coverage. Its Philips aim to exchange the swap unit within 48 hours after the request for service however for remote areas like Island or other geographically difficult to reach area, its Philips aim to have an exchange time within 72 hours.

The swap monitor remains yours and Philips keeps the defective/original monitor. For the swap monitor the warranty period remains equal to that of your original monitor, being 36 months as from the purchase date of your original monitor.

What is excluded?

The Philips Warranty applies provided the product is handled properly for its intended use, in accordance with its operating instructions and upon presentation of the original invoice or cash receipt, indicating the date of purchase, dealer's name and model and production number of the product.

The Philips Warranty may not apply if:

- The documents have been altered in any way or made illegible;
- The model or production number on the product has been altered, deleted, removed or made illegible;
- Repairs or product modifications and alterations have been executed by

unauthorized service organizations or persons;

- Damage is caused by accidents including but not limited to lightning, water or fire, misuse or neglect;
- Reception problems caused by signal conditions or cable or antenna systems outside the unit;
- Defects caused by abuse or misuse of the monitor;
- Product requires modification or adaptation to enable it to comply with local or national technical standards, which apply in countries for which the product was not originally designed, manufactured, approved and/or authorized. Therefore always check whether a product can be used in a specific country.
- Note that products that are not originally designed, manufactured, approved and/or authorized for usage within the Philips countries, do not apply to the Philips First Choice Warranty. In these cases the Philips global warranty terms are valid.

Just a click away

In case of any problems, we advise you to read the operating instructions carefully or go to the <http://www.philips.com/support> website for additional support.

Just a phone call away

In order to avoid unnecessary inconvenience, we advise you to read the operating instructions carefully or go to the <http://www.philips.com/support> website for additional support before contacting the Philips helpdesk.

To solve your problem quickly, please prepare the following details before contacting the Philips helpdesk:

- Philips type number
- Philips serial number
- Purchase date (copy of purchase may be required)
- PC environment Processor:

7. Customer care and warranty

- CUP and Graphic card name and driver version
- Operating system
- Application being used
- Other cards installed

Having the following information available will also help speed up the process:

- Your proof of purchase indicating: date of purchase, dealer name, model and product serial number.
- The full address to which the faulty monitor has to be collected and the good model should be delivered.

Philips' customer help desks are located worldwide.

Or you can reach us via:

Website: <http://www.philips.com/support>

Contact Information for West European region:

Germany	+49	01803 386 853	€0,09
United Kingdom	+44	0207 949 0069	Local call tariff
Ireland	+353	01 601 1161	Local call tariff
Spain	+34	902 888 785	€0,10
Finland	+358	09 2290 1908	Local call tariff
France	+33	082161 1658	€0,09
Greece	+30	00800 3122 1223	Free Of Charge
Italy	+39	840 320 041	€0,08
Netherlands	+31	0900 0400 063	€0,10
Denmark	+45	3525 8761	Local call tariff
Norway	+47	2270 8250	Local call tariff
Sweden	+46	08 632 0016	Local call tariff
Poland	+48	0223491505	Local call tariff
Austria	+43	0810 000206	€0,07
Belgium	+32	078 250851	€0,06
Luxembourg	+352	26 84 30 00	Local call tariff
Portugal	+351	2 1359 1440	Local call tariff
Switzerland	+41	02 2310 2116	Local call tariff

Your Guarantee in Central and Eastern Europe

Dear Customer,

Thank you for purchasing this Philips monitor:

All Philips monitors are designed and manufactured to high standards and deliver high-quality performance, ease of use and ease of installation. Should you encounter any difficulties while installing or using this product, please contact the Philips helpdesk directly to benefit from your Philips Warranty conditions. This service warranty entitles you to get a solution depending on the model you purchased when your monitor turns out to be faulty or defective.

What is covered?

This Philips Guarantee in Central and Eastern Europe applies within Czech Republic, Hungary, Russia, Slovakia, Slovenia, Turkey, Romania, Bulgaria, Ukraine, Baltic states, Serbia & Montenegro and Croatia and only for monitors originally designed, manufactured, approved and/or authorized for usage within these countries.

Warranty coverage begins as from the day you buy your monitor and be serviced in case of defects provided for under the warranty coverage, for a warranty period of 24 months for Philips C, E, T, V, and X models and for models B, P and S we give 36 months. Your original purchase document is your proof for the purchase day, so keep this carefully stored and available when a warranty service is requested.

Depending on your region you can deliver your monitor to the address of our Certified Service Center or your monitor will be picked-up at your address. After the monitor is repaired you can pick him up or it will be returned back to your address within 10 working days started when the defect units arrived in our service center.

If no Repair can be fulfilled within 10 working days after the unit is picked up then a replacement monitor of at least an equivalent monitor will be given to you.

The replacement monitor remains yours and Philips keeps the defective/original monitor. For the replacement monitor the warranty period remains equal to that of your original monitor.

What is excluded?

The Philips guarantee applies provided the product is handled properly for its intended use, in accordance with its operating instructions and upon presentation of the original invoice or cash receipt, indicating the date of purchase, dealer's name and model and production number of the product.

The Philips guarantee may not apply if:

- The documents have been altered in any way or made illegible;
- The model or production number on the product has been altered, deleted, removed or made illegible;
- Repairs or product modifications and alterations have been executed by unauthorized service organizations or persons;
- Damage is caused by accidents including but not limited to lightning, water or fire, misuse or neglect.
- Reception problems caused by signal conditions or cable or antenna systems outside the unit;
- Defects caused by abuse or misuse of the monitor;
- Product requires modification or adaptation to enable it to comply with local or national technical standards, which apply in countries for which the product was not originally designed, manufactured, approved and/or authorized. Therefore always check whether a product can be used in a specific country.

Please note that the product is not defective under this guarantee in the case where modifications become necessary in order for the product to comply with local or national technical standards which apply in countries for which the product was not originally designed and/or manufactured. Therefore always check whether a product can be used in a specific country.

Just a click away

In case of any problems, we advise you to read the operating instructions manual or your warranty card carefully or go to the www.philips.com/support website for additional support.

Just a phone call away

You need to check your official warranty card delivered to you at your day of purchase for the nearest contact details of your authorized service contact.

In case not available please check your country contact showing below.

In order to avoid unnecessary inconvenience, we advise you to read the operating instructions carefully before contacting our dealers or Information Centers.

In case your Philips product is not working correctly or is defective, please contact your Philips dealer or directly the Philips Service and Consumer Information Centers.

Website: <http://www.philips.com/support>

Eastern Europe

BELARUS

IBA
Technical Center of JV IBA
M. Bogdanovich str. 155
BY - 220040 Minsk
Tel: +375 17 217 33 86

Service.BY

Petrus Brovky st. 19 – 101-B
220072, Minsk
Belarus

BULGARIA

LAN Service
140, Mimi Balkanska Str.
Office center Translog
1540 Sofia, Bulgaria
Tel: +359 2 960 2360
www.lan-service.bg

CZECH REPUBLIC

A-Support
General Consumer Information Center
800 100 697

CROATIA

Renoprom d.o.o.
Ljubljanska 4,
Sv. Nedjelja, 10431
Croatia
Tel: +385 1 333 0974

ESTONIA

FUJITSU SERVICES OU
Akadeemia tee 21G
EE-12618 Tallinn
Tel: +372 6519900
www.ee.invia.fujitsu.com

HUNGARY

Serware Szerviz
Vizimolnár u. 2-4
HU - 1031 Budapest
Tel: +36 1 2426331
Email: inbox@serware.hu
www.serware.hu

Profi Service Center Ltd.
123 Kulso-Vaci Street,
H-1044 Budapest (Europe Center)
Hungary
Tel: +36 1 814 8080
m.andras@psc.hu

LATVIA

ServiceNet LV
Jelgavas iela 36
LV - 1055 Riga,
Tel: +371 7460399
Email: serviss@servicenet.lv

LITHUANIA

ServiceNet LT
Gaiziunu G. 3
LT - 3009 KAUNAS
Tel: +370 7400088
Email: servisas@servicenet.lt
www.servicenet.lt

ROMANIA

Blue Ridge Int'l Computers SRL
115, Mihai Eminescu St., Sector 2
RO - 020074 Bucharest
Tel: +40 21 2101969

SERBIA & MONTENEGRO

Kim Tec d.o.o.
Viline vode bb, Slobodna zona
Beograd L12/3
11000 Belgrade
Serbia
Tel. +381 11 20 70 684

SLOVAKIA

General Consumer Information Center
0800004551
Datalan Servisne Stredisko
Puchovska 8
SK - 831 06 Bratislava
Tel: +421 2 49207155
Email: servis@datalan.sk

SLOVENIA

PC HAND
Brezovce 10
SI - 1236 Trzin
Tel: +386 1 530 08 24
Email: servis@pchand.si

RUSSIA

CPS
18, Shelepihinskaya nab.
123290 Moscow
Russia
Tel. +7(495)797 3434

TURKEY

See warranty card for local support
Central Turkey:
Tecpro
Telsizler Mah. 10
Kagithana, Istanbul, Turkey
Tel: +90 212 444 4 832

UKRAINE

Comel
Shevchenko street 32
UA - 49030 Dnepropetrovsk
Tel: +380 562320045
www.csp-comel.com LLC Topaz Company

Topaz-Service Company,
Mishina str. 3,
Kiev
Ukraine-03151
Tel: +38 044 245 73 31

In order to avoid unnecessary inconvenience, we advise you to read the operating instructions carefully before contacting your dealer. If you have questions which your dealer cannot answer or any related question please contact the Philips Consumer Information Centers or via:
Website: <http://www.philips.com>

Latin America

TO GET WARRANTY SERVICE IN ARGENTINA and BRAZIL.

Please contact Philips at:

Brazil :

Consumer care number : 0800-7254101
E-mail address : CIC.monitores@Philips.com
Monday to Friday:
8:00am - 8:00pm

Argentina :

Consumer care number : 0800 3330 856
E-mail address : CIC.monitores@Philips.com
Monday to Friday:
8:00am - 8:00pm

BRAZIL

Company : See ASP-BRZ
Address : Rod. Anhanguera, Km 49 Pista Sul -
Bairro: Terra Nova - Jundiaí/SP
CEP 13210-877 – Brasil
Tel: 55 11 4531-8438
Email: moacir:minozzo@aoc.com.br

ARGENTINA

Company : See ASP-ARG
Address : Azopardo 1480
(C1107ADZ) Cdad. de Buenos Aires
Tel: 54 11 4103-4113
Email: hlew@megatech.la

Pacific: Three Years Free Labor / Three Years Free Service on Parts

Australia:

Company: AGOS NETWORK PTY LTD
Address: 4/5 Dursley Road, Yennora, NSW 2161,
Australia
Tel: 1300 360 386
Fax: +61-2-80808147
Email: philips@agos.com.au
Service hours: Mon.~Fri. 8:00am-7:30pm

New Zealand:

Company: Visual Group Ltd.
Address: 28 Walls Rd Penrose Auckland
Phone: 0800 657447
Fax: 09 5809607
E-mail: vai.ravindran@visualgroup.co.nz
Service Hours: Mon.~Fri. 8:30am~5:30pm

Asia (except for Korea) : Three Years Free Labor / Three Years Free Service on Parts

Hong Kong:

Company: Smart Pixels Technology Ltd.
Address: 9/F Wilson Logistics Center 24-28 Kung
Kip Street Kwai Chung, N.T., Hong Kong.
Tel: +852 2619 9639
Fax: +852 2148 3123
E-mail: service@smartpixels.com.hk
Service hours: Mon. To Fri.: 9:00am-6:00pm, Sat.:
9:00am-1:00pm

Macau:

Company: Smart Pixels Technology Ltd.
Address: RUA DO PE. ANT ROLIZ NO.2H R/C +
SL(A) HONG FOK KOK, MACAU
澳門羅神父街鴻福閣二號H舖
Tel: (853)-0800-987
Fax: (853)-2855-2228
E-mail: service@smartpixels.com.hk
Service hours: Mon. To Fri.: 9:00am-6:00pm, Sat.:
9:00am-1:00pm

China

TO GET WARRANTY SERVICE IN CHINA.

Please contact Philips at:

Consumer care number : 4008 800 008

E-mail address : philips_helpdesk@vavotelecom.com

7days: 8am - 6pm

India:

Company: REDINGTON INDIA LTD

Address: SPL Guindy House, 95 Mount Road, Chennai 600032, India

Tel: 1 800 425 6396

E-mail: callcentre@philipsmonitors.co.in

SMS: PHILIPS to 56677

Service hours: Mon.~Fri. 9:00AM~5:30PM;

Indonesia:

Company: PT. Gadingsari elektronik Prima

Address: Kompleks Pinang 8, Jl. Ciputat raya No. 8F, Pondok Pinang, Jakarta

Tel: 62 21 75909053, 75909056, 7511530

Fax: 62 21 7510982

E-mail: gepta@cbn.net.id

Service hours: Mon.~Fri. 8:30am~4:30pm; Sat. 8:30am~2:00pm

Coverage: Jakarta, Bekasi, Krawang, Bogor, Depok, Tangerang, Serpong, Serang

Additional service points:

1. ASC MEDAN

Address: Jl.Kakap No.32G, Medan

Phone: 62 61 4538920

Coverage: Medan, Aceh, Pematang Siantar, Pekanbaru, Padang

2. ASC YOGYA

Address: Jl.Pembela Tanah Air No.15, Yogyakarta

Phone: 62 274 564791

Coverage: Yogyakarta, Solo, Semarang, Magelang

3. ASC SURABAYA

Address: HI-TECH Mall Lt.2 ,Blok C1-12A

Jl.Kusuma Bangsa 116-118, Surabaya

Phone: 62 31 5353573

Coverage: Surabaya, Malang, Pasuruan, Bojonegoro, Kediri, Gersik

4. ASC BALI

Address: Jl.Pulau Nusa Penida No.28 Denpasar-Bali

Phone: 62 813 31821822

Coverage: Denpasar, Kuta, Nusa Dua, Gianyar, Bedugul

5. ASC BANDUNG

Address: Segitiga Mas Kosambi Blok G-9 Jl.Jend A.Yani ,Bandung

Phone: 62 22 7237009

Coverage: Bandung, Cirebon, Ciamis, Sukabumi

South Korea:

Company: PCS One Korea Ltd.

Address: 112-2, Banpo-dong, Seocho-ku, Seoul, 137-040, Korea

Call Center Tel: 080-600-6600

Tel: 82 2 591 1528

Fax: 82 2 595 9688

E-mail: cic_korea@philips.com

Service hours: Mon.~Fri. 9:00AM~ 6:00PM; Sat. 9:00AM~1:00PM

Malaysia:

Company: After Market Solutions (CE) Sdn Bhd

Address: Lot 6. Jalan 225/51A, 46100 Petaling Jaya, Selangor DE, Malaysia.

Phone: 603 7953 3370

Philips Info Line: 1-800-880-180

Fax: 603 7953 3338

E-mail: pceinfo.my@philips.com

Service Hours: Mon.~Fri. 8:15am~5:15pm; Sat. 9:00am~1:00pm

Pakistan:

Philips Consumer Service

Address: Mubarak manzil, 39, Garden Road, Saddar, Karachi-74400

Tel: (9221) 2737411-16

Fax: (9221) 2721167

E-mail: care@philips.com

Service hours: Mon.~Sat. 09:30am~1:00pm & 2:00pm~5:30pm

Philippines:

Company: Glee Electronics, Inc.
Address: Unit 1103-1104 11F The Taipan Place
Bldg. F. Ortigas Center Pasig City
Tel: (02) 633-4533 to 34 / (02) 637-6559 to 60
Fax: (02) 6334563
E-mail: jim.gawson@glee.com.ph
Service hours: Mon.~Fri. 8:00am~6:00pm

Singapore:

Company: Philips Electronics Singapore Pte Ltd
(Philips Consumer Care Center)
Address: 620A Lorong 1 Toa Payoh, TP4 Building
Level 1, Singapore 319762
Tel: (65) 6882 3999
Fax: (65) 62508037
E-mail: consumer.care.sg@philips.com
Service hours: Mon.~Fri. 9:00am~6:00pm; Sat.
9:00am~1:00pm

Taiwan:

Company: FETEC.CO
Address: No.499, Ciwen Rd., Taoyuan City, Taoyuan
County 330, Taiwan
Consumer Care: 0800-231-099
Tel: (03)3169920
Fax: (03)3169930
E-mail: knlin08@xuite.net
Service hours: Mon.~Fri. 8:30am~7:00pm

Thailand:

Company: Axis Computer System Co., Ltd.
Address: 1421 Soi Lardprao 94, Srivara Town In
Town Soi 3 Road, Wangthonglang, Bangkok 10310
Thailand
Tel: (662) 934-5498
Fax: (662) 934-5499
E-mail: axis5@axiscomputer.co.th
Service Hours: Mon.~Fri. 08:30am~05:30pm

Vietnam:

1. Ho Chi Minh City :
Company: FPT Service Informatic Company Ltd. -
Ho Chi Minh City Branch
Address: 207/4 Nguyen Van Thu Street, District 1,
HCM City
Tel: +84 8 38248007
Fax: +84 8 38248010
E-mail: Thanght@fpt.com.vn
Service hours: Mon. To Fri.: 8:00am–12:00am,
1:30pm–5:30pm; Sat.: 8:00am-12:00am

2. Danang City :

Company: FPT Service Informatic Company Ltd. -
Da nang Office
Address: 336 Le Duan Street - Thanh Khe District
- Đà Nang City
Tel: 05113.562666; Fax: 05113.562662
Tel: +84 511 3562666
Fax: +84 511 3562662
E-mail: khangndv@fpt.com.vn
Service hours: Mon. To Fri.: 8:00am-12:00am,
1:30pm–5:30pm; Sat.: 8:00am-12:00am

3. Can tho Province :

Company: FPT Service Informatic Company Ltd. -
Can Tho Office
Address: 71/4 Tran Phu Street, Ninh Kieu District,
Can tho City
Tel: +84 5113.562666
Fax: +84 5113.562662
E-mail: nhieptv@fpt.com.vn
Service hours: Mon. To Fri.: 8:00am-12:00am,
1:30pm-5:30pm; Sat.: 8:00am-12:00am

Africa

South Africa:

Company name: Sylvara Technologies Pty Ltd
Address: Ho Address Palm Springs Centre
Christoffel Road Van Riebeeck Park Kempton Park,
South Africa
Tel: 086 000 0888
Fax: +2711 391 1060
E-mail: monitorcare@philipssupport.co.za
Service hours: Mon.~ Fri. 08:00am~05:00pm

Middle East

United Arab Emirates:

Company: AL SHAHD COMPUTER L.L.C
Address: P.O.BOX: 29024, DUBAI, UNITED ARAB
EMIRATES
TEL: 00971 4 2276525
FAX: 00971 4 2276242
E-mail: shahd52@eim.ae
Service hours: Sat.~Thur: 9:00am~1:00pm &
4:00pm- 8:00pm

Israel:

Company: Eastronics LTD
Address: 13 Rozanis St. P.O.B. 39300, Tel Aviv
61392 Israel
Tel: 1-800-567000 call free in Israel; (972-50-
8353722 after service hours until 20:00)
Fax: 972-3-6458759
E-mail: eastronics@eastronics.co.il
Service hours: Sun.~Thurs. 08:00 - 18:00

Your Philips F1rst Choice Warranty(USA)

Thank you for purchasing this Philips monitor:

All Philips monitors are designed and manufactured to high standards and deliver high-quality performance, ease of use and ease of installation. Should you encounter any difficulties while installing or using this product, please contact Philips directly to benefit from your Philips F1rst Choice Warranty. This three-year service warranty entitles you to a swap model on-site within 48 hours of your call being received within the first year of purchase. If you have any problems with your monitor within the second or third year of purchase, we will repair it after it has been sent to the service provider at your expense and returned to you within five working days, free of charge.

LIMITED WARRANTY (Computer Monitor)

Please contact us via Website: <http://www.philips.com> or <http://www.usa.philips.com> to access the Warranty Registration Card.

Three Years Free Labor / Three Years Free Service on Parts / One Year Exchange*

*Product will be exchanged with a new or renewed to original specifications unit within two business days for the first year. This product must be shipped in at your expense for service during years two and three.

WHO IS COVERED?

You must have proof of purchase to receive warranty service. A sales receipt or other document showing that you purchased the product is considered proof of purchase. Attach it to this owner's manual and keep both nearby.

WHAT IS COVERED?

Warranty coverage begins the day you buy your product. For three years thereafter, all parts will be repaired or replaced, and labor is free. After three years from the day of purchase, you pay for the replacement or repair of all parts, and for all labor charges.

All parts, including repaired and replaced parts, are covered only for the original warranty period. When the warranty on the original product expires, the warranty on all replaced and repaired products and parts also expires.

WHAT IS EXCLUDED?

Your warranty does not cover:

Labor charges for installation or setup of the product, adjustment of customer controls on the product, and installation or repair of antenna systems outside of the product.

product repair and/or part replacement because of misuse, accident, unauthorized repair or other cause not within the control of Philips.
reception problems caused by signal conditions or cable or antenna systems outside the unit.

a product that requires modification or adaptation to enable it to operate in any country other than the country for which it was designed, manufactured, approved and/or authorized, or repair of products damaged by these modifications.

incidental or consequential damages resulting from the product. (Some states do not allow the exclusion of incidental or consequential damages, so the above exclusion may not apply to you. This includes, but is not limited to, prerecorded material, whether copyrighted or not copyrighted.)
the model or production number on the product has been altered, deleted, removed or made illegible.

Where IS SERVICE AVAILABLE?

Warranty service is available in all countries where the product is officially distributed by Philips. In countries where Philips does not distribute the product, the local Philips service organization will attempt to provide service (although there may be a delay if the appropriate spare parts and technical manual(s) are not readily available).

Where CAN I GET MORE INFORMATION?

For more information, contact the Philips Customer Care Center by calling (877) 835-1838 (U.S.A. customers only) or (919) 573-7855.

Before Requesting Service...

Please check your owner's manual before requesting service. Adjustments of the controls discussed there may save you a service call.

TO GET WARRANTY SERVICE IN U.S.A., PUERTO RICO OR U.S. VIRGIN ISLANDS...

Contact the Philips Customer Care Center phone number listed below for product assistance and procedures for servicing:

Philips Customer Care Center

(877) 835-1838 or (919) 573-7855

(In U.S.A., Puerto Rico and U.S. Virgin Islands, all implied warranties, including implied warranties of merchantability and fitness for a particular purpose, are limited in duration to the duration of this express warranty. But, because some states do not allow limitations on how long an implied warranty may last, this limitation may not apply to you.)

TO GET WARRANTY SERVICE IN CANADA...

Please contact Philips at:
(800) 479-6696

Four years free parts and Four years free labor will be provided at Philips Canada depot or any one of its authorized service centers.

(In Canada, this warranty is given in lieu of all other warranties. No other warranties are expressed or implied, including any implied warranties of merchantability or fitness for a particular purpose. Philips is not liable under any circumstances for any direct, indirect, special, incidental or consequential damages, howsoever incurred, even if notified of the possibility of such damages.)

REMEMBER... Please record the model and serial numbers found on the product below.

MODEL # _____

SERIAL # _____

This warranty gives you specific legal rights. You may have other rights which vary from state/province to state/province.

Before contacting Philips, please prepare the following details so we can solve your problem quickly.

- Philips type number
 - Philips serial number
 - Purchase date (copy of purchase may be required)
 - PC environment Processor:
 - CPU and Graphic card name and driver version
 - Operating system
 - Application being used
 - Other cards installed
- Having the following information available will also help speed up the process:
- Your proof of purchase indicating: date of purchase, dealer name, model and product serial number:

- The full address to which the swap model should be delivered.

Just a phone call away

Philips' customer help desks are located worldwide. Within the Canada you can contact Philips customer care Monday-Friday from 9:00 AM-6:00 PM Eastern Time (ET). For more information on this and more great Philips products visit our website at:

Website: <http://www.philips.com>

Your International Guarantee

Dear Customer,

Thank you for purchasing this Philips product which has been designed and manufactured to the highest quality standards.

If, unfortunately, something should go wrong with this product Philips guarantees free of charge labor and replacement parts irrespective of the country where it is repaired during a period of 12 months from date of purchase. This international Philips guarantee complements the existing national guarantee obligations to you of dealers and Philips in the country of purchase and does not affect your statutory rights as a customer:

The Philips guarantee applies provided the product is handled properly for its intended use, in accordance with its operating instructions and upon presentation of the original invoice or cash receipt, indicating the date of purchase, dealer's name and model and production number of the product.

The Philips guarantee may not apply if:

- the documents have been altered in any way or made illegible;
- the model or production number on the product has been altered, deleted, removed or made illegible;
- repairs or product modifications and alterations have been executed by unauthorized service organizations or persons;
- damage is caused by accidents including but not limited to lightning, water or fire, misuse or neglect.

Please note that the product is not defective under this guarantee in the case where modifications become necessary in order for the product to comply with local or national technical standards which apply in countries for which the product was not originally designed and/or manufactured.

Therefore always check whether a product can be used in a specific country.

In case your Philips product is not working correctly or is defective, please contact your Philips dealer. In the event you require service whilst in another country a dealer address can be given to you by the Philips Consumer Help Desk in that country, the telephone and fax number of which can be found in the relevant part of this booklet.

In order to avoid unnecessary inconvenience, we advise you to read the operating instructions carefully before contacting your dealer. If you have questions which your dealer cannot answer or any related question please contact the Philips Consumer Information Centers or via:

Website: <http://www.philips.com>

8 Troubleshooting & FAQs

8.1 Troubleshooting

This page deals with problems that can be corrected by a user. If the problem still persists after you have tried these solutions, contact Philips customer service representative.

1 Common Problems

No Picture (Power LED not lit)

- Make sure the power cord is plugged into the power outlet and into the back of the monitor.
- First, ensure that the power button on the front of the monitor is in the OFF position, then press it to the ON position.

No Picture (Power LED is white blinking)

- Make sure the computer is turned on.
- Make sure the signal cable is properly connected to your computer.
- make sure the monitor cable has no bent pins on the connect side. If yes, repair or replace the cable.
- The Energy Saving feature may be activated

Screen says

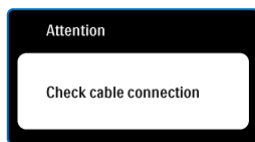

- Make sure the monitor cable is properly connected to your computer. (Also refer to the Quick Start Guide).
- Check to see if the monitor cable has bent pins.
- Make sure the computer is turned on.

AUTO button doesn't function

- The auto function is applicable only in VGA-Analog mode. If the result is not satisfactory, you can do manual adjustments via the OSD menu.



Note

The Auto Function is not applicable in DVI-Digital mode as it is not necessary.

Visible signs of smoke or sparks

- Do not perform any troubleshooting steps
- Disconnect the monitor from mains power source immediately for safety
- Contact with Philips customer service representative immediately.

2 Imaging Problems

Image is not centered

- Adjust the image position using the "Auto" function in OSD Main Controls.
- Adjust the image position using the Phase/Clock of Setup in OSD Main Controls. It is valid only in VGA mode.

Image vibrates on the screen

- Check that the signal cable is properly securely connected to the graphics board or PC.

Vertical flicker appears



- Adjust the image using the "Auto" function in OSD Main Controls.
- Eliminate the vertical bars using the Phase/Clock of Setup in OSD Main Controls. It is valid only in VGA mode.

Horizontal flicker appears



- Adjust the image using the "Auto" function in OSD Main Controls.
- Eliminate the vertical bars using the Phase/Clock of Setup in OSD Main Controls. It is valid only in VGA mode.

Image appears blurred, indistinct or too dark

- Adjust the contrast and brightness on On-Screen Display.

An "after-image", "burn-in" or "ghost image" remains after the power has been turned off.

- Uninterrupted display of still or static images over an extended period may cause "burn in", also known as "after-imaging" or "ghost imaging", on your screen. "Burn-in", "after-imaging", or "ghost imaging" is a well-known phenomenon in monitor panel technology. In most cases, the "burned in" or "after-imaging" or "ghost imaging" will disappear gradually over a period of time after the power has been switched off.
- Always activate a moving screen saver program when you leave your monitor unattended.
- Always activate a periodic screen refresh application if your monitor will display unchanging static content.
- Severe "burn-in" or "after-image" or "ghost image" symptoms will not disappear and cannot be repaired. The damage mentioned above is not covered under your warranty.

Image appears distorted. Text is fuzzy or blurred.

- Set the PC's display resolution to the same mode as monitor's recommended screen native resolution.

Green, red, blue, dark, and white dots appears on the screen

- The remaining dots are normal characteristic of the liquid crystal used in today's technology. Please refer the pixel policy for more detail.

The "power on" light is too strong and is disturbing

- You can adjust "power on" light using the power LED Setup in OSD main Controls.

3 Audio problem

No sound

- Check if audio cable is connected to PC and monitor correctly.
- Ensure audio is not muted. Press OSD "Menu", select "Audio" then "Mute". Check it on "Off" position.
- Press "Volume" in OSD main control to adjust the volume.

4 USB problem

USB peripherals are not working

- Check if USB upstream cable is connected to your monitor correctly
- Turn your monitor OFF and ON once again. You may need to install/reinstall USB drivers in your PC and ensure hub is active.
- Reconnect your USB peripherals

For further assistance, refer to the Consumer Information Centers list and contact Philips customer service representative.

8.2 SmartControl Premium FAQs

Q1. I change the monitor on a PC to a different one and the SmartControl Premium becomes un-usable, what do I do?

Ans.: Restart your PC and see if SmartControl Premium can work. Otherwise, you will need to remove and re-install SmartControl Premium to ensure proper driver is installed.

Q2. The SmartControl Premium functions worked well before, but it does not work anymore, what can I do?

Ans.: If the following actions were executed, the monitor driver may need to be re-installed.

- Changed video graphic adapter to another one
- Updated video driver
- Activities on OS, such as service pack or patch
- Run Windows Update and updated monitor and/or video driver
- Windows was booted with the monitor power off or disconnected. To find out, please right click My Computer and click on Properties->Hardware-> Device Manager. If you see "Plug and Play Monitor" shows under Monitor; then you need to re-install. Simply remove SmartControl Premium and re-install it.

Q3. After installing SmartControl Premium, when clicking on SmartControl Premium tab, nothing shows up after a while or a failure message shows, what happened?

Ans.: It might be your graphic adaptor is not compatible with the SmartControl Premium. If your graphic adaptor is one of the above mentioned brands, try to download the most updated graphic adaptor driver from corresponding companies' web site. Install the driver. Remove SmartControl Premium, and re-install it once more. If it is still not working, we are sorry that the graphic adaptor is not supported. Please visit Philips website and check if an updated SmartControl Premium driver is available.

Q4. When I click on Product Information, only partial information is shown, what happened?

Ans.: It might be your graphic card adaptor driver is not the most updated version which fully supporting DDC/CI interface. Please try to download the most updated graphic adaptor driver from corresponding companies' web site. Install the driver. Remove SmartControl Premium and re-install it once more.

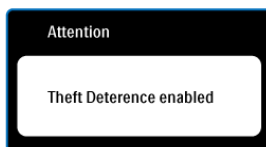

Q5. I forgot my PIN for Theft Deterrence Function. What can I do?

Ans.: Philips Service center has a right to ask for legitimate identification and authorization, in order to establish ownership of the monitor.

Please note that the anti-theft deterrence function is provided as a convenient free option. Managing PIN numbers is the sole responsibility of the individual user or the organization who sets it.

In case the PIN number is forgotten, Philips service center can re-set it for you at a nominal charge after verification of ownership. Please note that this activity is not covered by standard warranty terms.

Q6. In a monitor with the SmartImage feature, the sRGB scheme of color temperature function in SmartControl Premium is not responding, why?

Ans.: When SmartImage is enabled, the sRGB scheme is disabled automatically. To use sRGB, you need to disable SmartImage with the  button at the front bezel of your monitor.

8.3 General FAQs

Q1: When I install my monitor what should I do if the screen shows 'Cannot display this video mode'?

Ans.: Recommended resolution for this monitor: 1920x1080 @60Hz.

- Unplug all cables, then connect your PC to the monitor that you used previously.
- In the Windows Start Menu, select Settings/ Control Panel. In the Control Panel Window, select the Display icon. Inside the Display Control Panel, select the 'Settings' tab. Under the setting tab, in box labeled 'desktop area', move the sidebar to 1920x1080 pixels.
- Open 'Advanced Properties' and set the Refresh Rate to 60Hz, then click OK.
- Restart your computer and repeat step 2 and 3 to verify that your PC is set at 1920x1080@60Hz.
- Shut down your computer; disconnect your old monitor and reconnect your Philips monitor.
- Turn on your monitor and then turn on your PC.

Q2: What is the recommended refresh rate for monitor?

Ans.: Recommended refresh rate in monitors is 60Hz. In case of any disturbance on screen, you can set it up to 75Hz to see if that removes the disturbance.

Q3: What are the .inf and .icm files on the CD-ROM? How do I install the drivers (.inf and .icm)?

Ans.: These are the driver files for your monitor. Follow the instructions in your user manual to install the drivers. Your computer may ask you for monitor drivers (.inf and .icm files) or a driver disk when you first install your monitor. Follow the instructions to insert the (companion CD-ROM) included in this package. Monitor drivers (.inf and .icm files) will be installed automatically.

Q4: How do I adjust the resolution?

Ans.: Your video card/graphic driver and monitor together determine the available resolutions. You can select the desired resolution under Windows® Control Panel with the "Display properties".

Q5: What if I get lost when I am making monitor adjustments via OSD?

Ans.: Simply press the OK button, then select 'Reset' to recall all of the original factory settings.

Q6: Is the monitor screen resistant to scratches?

Ans.: In general it is recommended that the panel surface is not subjected to excessive shocks and is protected from sharp or blunt objects. When handling the monitor, make sure that there is no pressure or force applied to the panel surface side. This may affect your warranty conditions.

Q7: How should I clean the monitor surface?

Ans.: For normal cleaning, use a clean, soft cloth. For extensive cleaning, please use isopropyl alcohol. Do not use other solvents such as ethyl alcohol, ethanol, acetone, hexane, etc.

Q8: Can I change the color setting of my monitor?

Ans.: Yes, you can change your color setting through OSD control as the following procedures,

- Press "OK" to show the OSD (On Screen Display) menu
- Press "Down Arrow" to select the option "Color" then press "OK" to enter color setting, there are three settings as below.
 1. Color Temperature; The six settings are 5000K, 6500K, 7500K, 8200K, 9300K and 11500K. With settings in the 5000K range the panel appears 'warm,' with a red-white color tone, while a 11500K temperature yields 'cool, blue-white toning.'
 2. sRGB; this is a standard setting for ensuring correct exchange of colors between different device (e.g. digital cameras, monitors, printers, scanners, etc)
 3. User Define; the user can choose his/her preference color setting by adjusting red, green blue color.

Note:

A measurement of the color of light radiated by an object while it is being heated. This measurement is expressed in terms of absolute scale, (degrees Kelvin). Lower Kevin temperatures such as 2004K are red; higher temperatures such as 9300K are blue. Neutral temperature is white, at 6504K.

Q9: Can the Philips monitor be mounted on the wall?

Ans.: Yes, Philips monitors have this optional feature. Four standard VESA mount holes on the rear cover allows the user to mount the Philips monitor on most of the

VESA standard arms or accessories. We recommend you to contact your Philips sales representative for more information.

Q10: Can I connect my monitor to any PC, workstation or Mac?

Ans.: Yes. All Philips monitors are fully compatible with standard PCs, Macs and workstations. You may need a cable adapter to connect the monitor to your Mac system. Please contact your Philips sales representative for more information.

Q11: Are Philips monitors Plug-and- Play?

Ans.: Yes, the monitors are Plug-and-Play compatible with Windows 7/Vista/XP/NT, Mac OSX, Linux

Q12: What is Image Sticking, or Image Burn-in, or After Image, or Ghost Image in monitor panels?

Ans.: Uninterrupted display of still or static images over an extended period may cause "burn in", also known as "after-imaging" or "ghost imaging", on your screen. "Burn-in", "after-imaging", or "ghost imaging" is a well-known phenomenon in monitor panel technology. In most cases, the "burned in" or "after-imaging" or "ghost imaging" will disappear gradually over a period of time after the power has been switched off. Always activate a moving screen saver program when you leave your monitor unattended. Always activate a periodic screen refresh application if your monitor will display unchanging static content.

Warning

Severe "burn-in" or "after-image" or "ghost image" symptoms will not disappear and cannot be repaired. The damage mentioned above is not covered under your warranty.

Q13: Why is my Display not showing sharp text, and is displaying jagged characters?

Ans.: Your monitor works best at its native resolution of 1920x1080@60Hz. For best display please use this resolution.



2011 © Koninklijke Philips Electronics N.V. All rights reserved.

Philips and the Philips Shield Emblem are registered trade marks of Koninklijke Philips Electronics N.V. and are used under license from Koninklijke Philips Electronics N.V.

Specifications are subject to change without notice.

M3241PE1Q