

Register your product and get support at
www.philips.com/support

50PFL3908
46PFL3908
46PFL3608
40PFL4908
39PFL2908
39PFL2608
32PFL4908
29PFL4908



EN User Manual

ES Manual del Usuario

FR Manuel d'Utilisation

EN For further assistance, call the customer support service in your country.

- To obtain assistance, contact Philips Customer Care Center;
In the U.S.A., Canada, Puerto Rico, or the U.S. Virgin Islands **1 866 309 5962**
México D.F. and Área Metropolitana; **58 87 97 36**
Interior de la Republica; **01 800 839 19 89**

ES Para obtener más información, llame al servicio de soporte al cliente de su país.

- Para obtener asistencia, comuníquese con Centro de atención al cliente de Philips;
En los Estados Unidos, en Canadá, Puerto Rico o en las Islas Vírgenes de los
Estados Unidos; **1 866 309 5962**
México D.F. y Área Metropolitana; **58 87 97 36**
Interior de la Republica; **01 800 839 19 89**

FR Pour obtenir de l'aide supplémentaire, communiquez avec le centre de service à la clientèle de votre pays.

- Pour obtenir de l'aide, communiquez avec le centre de service à la clientèle Philips au;
Dans le États-Unis, au Canada, à Puerto Rico ou aux Îles Vierges américaines; **1 866 309 5962**
México D.F. et Área Metropolitana; **58 87 97 36**
Interior de la Republica; **01 800 839 19 89**

PHILIPS

Contents

1 Notice 5

2 Important 7

| | |
|--------------------|---|
| Positioning the TV | 7 |
| Regulatory notices | 7 |
| Environmental care | 7 |

3 Get started 8

| | |
|---|----|
| Features | 8 |
| Supplied accessories | 8 |
| Symbols used in this User Manual | 8 |
| Stand assembly | 9 |
| Attaching the base | 9 |
| Managing cables | 10 |
| Installing the remote control batteries | 10 |
| Remote control | 11 |
| Control panel | 12 |
| Terminals | 12 |
| Connecting the antenna or the cable | 13 |
| Plugging in the AC power cord | 13 |
| Selecting your connection quality | 14 |
| Connecting your devices | 14 |
| Initial setup | 18 |

4 Use your TV 20

| | |
|---|----|
| Switching on your TV and putting it in Standby mode | 20 |
| Adjusting volume | 20 |
| Switching channels | 20 |
| Watching channels from an external device | 21 |
| Access the Home menu | 21 |
| Using auto mode | 22 |
| Create and use lists of favorite channels | 22 |
| Changing picture format | 23 |
| TV screen information | 23 |
| USB | 24 |

5 Use more of your TV 26

| | |
|--|----|
| Settings assistant | 27 |
| Picture | 27 |
| Sound | 29 |
| Features | 30 |
| Caption settings | 30 |
| Sleeptimer | 31 |
| Child and ratings lock | 31 |
| Change PIN | 33 |
| Installation | 33 |
| Language | 33 |
| Channel installation | 34 |
| Preferences | 35 |
| Use Philips EasyLink | 35 |
| Network | 37 |
| Return your settings to default values | 40 |
| Software | 40 |
| Checking your current software version | 40 |
| Preparing for the software upgrade | 40 |

| | |
|---|----|
| Upgrading the software | 41 |
| Automatically check for latest software | 41 |
| Netflix deactivation | 41 |
| Netflix ESN | 42 |
| VUDU deactivation | 42 |
| YouTube deactivation | 42 |
| Hulu Plus deactivation | 42 |
| License | 42 |
| Philips Wirelessconnect | 43 |
| View photos, play music and watch videos using DLNA | 43 |
| Net TV | 45 |
| Enjoying vTuner | 46 |
| Pandora® operations | 48 |

6 Useful tips 49

| | |
|-----------------|----|
| FAQ | 49 |
| Troubleshooting | 50 |

7 Information 52

| | |
|-------------|----|
| Glossary | 52 |
| Maintenance | 52 |

8 Specifications 53

9 Warranty 54

| | |
|---------|-------------|
| License | end of book |
|---------|-------------|

**Register online at www.productrecords.com/phl today
to get the very most from your purchase.**

Registering your model with Philips makes you eligible for all of the valuable benefits listed below, so don't miss out.

Register online at www.productrecords.com/phl to ensure:

*Product Safety Notification

By registering your product, you'll receive notification - directly from the manufacturer - in the rare case of a product recall or safety defect.

*Additional Benefits

Registering your product guarantees that you'll receive all of the privileges to which you're entitled, including special money-saving offers.

Know these **safety** symbols



The caution marking is located on the rear or bottom of the cabinet.



The lightning flash with arrowhead symbol, within an equilateral triangle, is intended to alert the user to the presence of uninsulated "dangerous voltage" within the apparatus's enclosure that may be of sufficient magnitude to constitute a risk of electric shock to persons.



The exclamation point within an equilateral triangle is intended to alert the user to the presence of important operating and maintenance (servicing) instructions in the literature accompanying the apparatus.

WARNING: To reduce the risk of fire or electric shock, do not expose this apparatus to rain or moisture. Apparatus shall not be exposed to dripping or splashing and no objects filled with liquids, such as vases, shall be placed on the apparatus.

CAUTION: To prevent electric shock, match wide blade of plug to wide slot, fully insert.

ATTENTION: Pour éviter les choc électriques, introduire la lame la plus large de la fiche dans la borne correspondante de la prise et pousser jusqu'au fond.

PHILIPS Visit our World Wide Web Site at www.philips.com/support

CHILD SAFETY:

PROPER TELEVISION PLACEMENT MATTERS

THE CONSUMER ELECTRONICS INDUSTRY CARES

- Manufacturers, retailers and the rest of the consumer electronics industry are committed to making home entertainment safe and enjoyable.
- As you enjoy your television, please note that all televisions – new and old- must be supported on proper stands or installed according to the manufacturer's recommendations. Televisions that are inappropriately situated on dressers, bookcases, shelves, desks, speakers, chests, carts, etc., may fall over, resulting in injury.

TUNE IN TO SAFETY

- **ALWAYS** follow the manufacturer's recommendations for the safe installation of your television.
- **ALWAYS** read and follow all instructions for proper use of your television.
- **NEVER** allow children to climb on or play on the television or the furniture on which the television is placed.
- **NEVER** place the television on furniture that can easily be used as steps, such as a chest of drawers.
- **ALWAYS** install the television where it cannot be pushed, pulled over or knocked down.
- **ALWAYS** route cords and cables connected to the television so that they cannot be tripped over, pulled or grabbed.

WALL OR CEILING MOUNT YOUR TELEVISION

- **ALWAYS** contact your retailer about professional installation if you have any doubts about your ability to safely mount your television.
- **ALWAYS** use a mount that has been recommended by the television manufacturer and has a safety certification by an independent laboratory (such as UL, CSA, ETL).
- **ALWAYS** follow all instructions supplied by the television and mount manufacturers.
- **ALWAYS** make sure that the wall or ceiling where you are mounting the television is appropriate. Some mounts are not designed to be mounted to walls and ceilings with steel studs or cinder block construction. If you are unsure, contact a professional installer.
- Televisions can be heavy. A minimum of two people is required for a wall or ceiling mount installation.

MOVING AN OLDER TELEVISION TO A NEW PLACE IN YOUR HOME

- Many new television buyers move their older CRT televisions into a secondary room after the purchase of a flat-panel television. Special care should be made in the placement of older CRT televisions.
- **ALWAYS** place your older CRT television on furniture that is sturdy and appropriate for its size and weight.
- **NEVER** place your older CRT television on a dresser where children may be tempted to use the drawers to climb.
- **ALWAYS** make sure your older CRT television does not hang over the edge of your furniture.

CE.org/safety



Important Safety Instructions

1. Read these instructions.
2. Keep these instructions.
3. Heed all warnings.
4. Follow all instructions.
5. Do not use this apparatus near water.
6. Clean only with dry cloth.
7. Do not block any ventilation openings. Install in accordance with the manufacturer's instructions.
8. Do not install near any heat sources such as radiators, heat registers, stoves, or other apparatus (including amplifiers) that produce heat.
9. Do not defeat the safety purpose of the polarized or grounding-type plug. A polarized plug has two blades with one wider than the other. A grounding type plug has two blades and a third grounding prong. The wide blade or the third prong are provided for your safety. If the provided plug does not fit into your outlet, consult an electrician for replacement of the obsolete outlet.
10. Protect the power cord from being walked on or pinched particularly at plugs, convenience receptacles, and the point where they exit from the apparatus.
11. Only use attachments / accessories specified by the manufacturer.
12. Use only with the cart, stand, tripod, bracket, or table specified by the manufacturer; or sold with the apparatus. When a cart is used, use caution when moving the cart / apparatus combination to avoid injury from tip-over.



13. Unplug this apparatus during lightning storms or when unused for long periods of time.
14. Refer all servicing to qualified service personnel. Servicing is required when the apparatus has been damaged in any way, such as power-supply cord or plug is damaged, liquid has been spilled or objects have fallen into the apparatus, the apparatus has been exposed to rain or moisture, does not operate normally, or has been dropped.

Note to the CATV system installer:

This reminder is provided to call the CATV system installer's attention to Article 820-40 of the NEC that provides guidelines for proper grounding and, in particular, specifies that the cable ground shall be connected to the grounding system of the building, as close to the point of cable entry as practical.

Example of Antenna Grounding as per NEC – National Electric Code

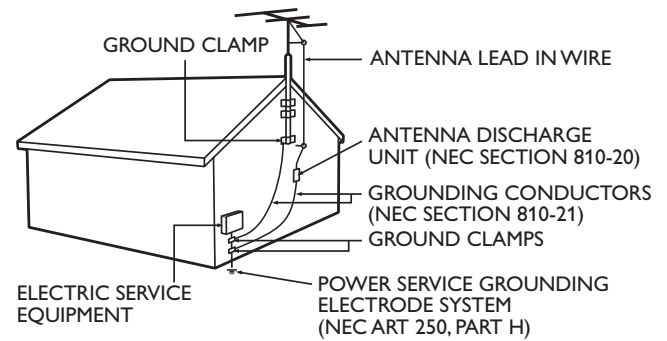

Wall Mount Bracket Kit

| | Brand | Model # | Screw dimension |
|---|---------|------------|-----------------------------------|
| 50PFL3908 / 46PFL3908 / 46PFL3608 | PHILIPS | SQM6485 | M6 x 1.614" (41mm) with spacer |
| 40PFL4908 / 39PFL2908 / 39PFL2608 | PHILIPS | SQM6435/17 | M6 x 1.614" (41mm) with spacer |
| 32PFL4908 / 29PFL4908 | SANUS | SAN18B | M4 x 0.472" (12mm) |

- The recommended Wall Mount Bracket Kit (sold separately) allows the mounting of the TV on the wall.
- For detailed information on installing the wall mount, refer to the Wall Mount Instruction Book.
- P&F USA is not responsible for any damage to the product or injury to yourself or others if you elect to install the TV Wall Mount Bracket or mount the TV onto the Bracket on your own.
- The Wall Mount Bracket must be installed by experts.

P&F USA is not liable for these types of accidents or injury noted below.

- Install the Wall Mount Bracket on a sturdy vertical wall.
- If installed onto a ceiling or slanted wall, the TV and Wall Mount Bracket may fall which could result in a severe injury.
- Do not use screws that are longer or shorter than their specified length. If screws too long are used this may cause mechanical or electrical damage inside the TV set. If screws too short are used this may cause the TV set to fall.
- Do not fasten the screws by excessive force. This may damage the product or cause the product to fall, leading to an injury.
- For safety reasons use 2 people to mount the TV onto a Wall Mounting Bracket.
- Do not mount the TV onto the Wall Mounting Bracket while your TV is plugged in or Turned On. It may result in an electrical shock injury.

When installing the unit on the wall, allow this much space.

| | |
|----------------------|--------------------|
| Top: | 11.8 inches (30cm) |
| Left and right side: | 5.9 inches (15cm) |
| Bottom: | 3.9 inches (10cm) |

1 Notice

Trademarks are the property of Koninklijke Philips N.V. or their respective owners.

P&F USA reserves the right to change products at any time without being obliged to adjust earlier supplies accordingly.

The material in this User Manual is believed adequate for the intended use of the system. If the product or its individual modules or procedures are used for purposes other than those specified herein, confirmation of their validity and suitability must be obtained. P&F USA warrants that the material itself does not infringe any United States patents. No further warranty is expressed or implied.

P&F USA cannot be held responsible neither for any errors in the content of this document nor for any problems as a result of the content in this document. Errors reported to P&F USA will be adapted and published on the P&F USA support website as soon as possible.

Pixel characteristics

This LCD product has a high number of color pixels. Although it has effective pixels of 99.999% or more, black dots or bright points of light (red, green or blue) may appear constantly on the screen. This is a structural property of the display (within common industry standards) and is not a malfunction.

Warranty

No components are user serviceable. Do not open or remove covers to the inside of the product. Repairs may only be done by Service Centers and official repair shops. Failure to do so shall void any warranty, stated or implied.

Any operation expressly prohibited in this User Manual, any adjustments or assembly procedures not recommended or authorized in this User Manual shall void the warranty.

Federal Communications Commission Notice

This equipment has been tested and found to comply with the limits for a Class B Digital device, pursuant to part 15 of the FCC Rules. These limits are designed to provide reasonable protection against harmful interference in a residential installation. This equipment generates, uses and can radiate radio frequency energy and, if not installed and used in accordance with the instructions, may cause harmful interference to radio communications. However, there is no guarantee that interference will not occur in a particular installation. If this equipment does cause harmful interference to radio or television reception, which can be determined by Turning the equipment Off and On, the user is encouraged to try to correct the interference by one or more of the following measures:

- Reorient or relocate the receiving antenna.
- Increase the separation between the equipment and the receiver.
- Connect the equipment into an outlet on a circuit different from that to which the receiver is connected.
- Consult the dealer or an experienced radio or television technician for help.

Declaration of Conformity

Trade Name : PHILIPS
Responsible Party : P&F USA, Inc.
Model : 50PFL3908, 46PFL3908, 46PFL3608, 40PFL4908, 39PFL2908, 39PFL2608, 32PFL4908, 29PFL4908
Address : PO Box 2248, Alpharetta, GA 30023-2248 U.S.A.
Telephone Number : 1 866 309 5962

Modifications

This apparatus may generate or use radio frequency energy. Changes or modifications to this apparatus may cause harmful interference unless the modifications are expressly approved in the User Manual. The user could lose the authority to operate this apparatus if an unauthorized change or modification is made.

Cables

Connections to this device must be made with shielded cables with metallic RFI / EMI connector hoods to maintain compliance with FCC Rules and Regulations.

Canadian notice

CAN ICES-3 (B)/NMB-3 (B)
Standard Television Receiving Apparatus, Canada BETS-7 / NTMR-7.

The following FCC/IC RSS-Gen is description of Wireless LAN adapter.

FCC Caution: Any changes or modifications not expressly approved by the party responsible for compliance could void the user's authority to operate this equipment.

This transmitter must not be co-located or operating in conjunction with any other antenna or transmitter.

Country Code Statement

For product available in the USA market, only channel 1~11 can be operated. Selection of other channels is not possible.

To maintain compliance with FCC RF exposure requirements, use only belt-clips, holsters or similar accessories that do not contain metallic components in its assembly. The use of accessories that do not satisfy these requirements may not comply with FCC RF exposure requirements and should be avoided.

FCC Radiation Exposure Statement

This equipment is compliance with SAR for general population/uncontrolled exposure limits in ANSI/IEEE C95.1-1999 and had been tested in accordance with the measurement methods and procedures specified in OET Bulletin 65 Supplement C. This equipment should be installed and operated with minimum distance 2.5cm between the radiator & your body.

This device complies with Industry Canada license-exempt RSS standard(s). Operation is subject to the following two conditions: (1) this device may not cause interference and (2) this device must accept any interference, including interference that may cause undesired operation of the device.

Copyright

All other registered and unregistered trademarks are the property of their respective owners.



The terms HDMI and HDMI High-Definition Multimedia Interface, and the HDMI Logo are trademarks or registered trademarks of HDMI Licensing LLC in the United States and other countries.



Manufactured under license from Dolby Laboratories. Dolby and the double-D symbol are trademarks of Dolby Laboratories.



SRS is a trademark of SRS Labs, Inc. TruSurround HD technology is incorporated under license from SRS Labs, Inc. SRS TruSurround HD™ creates an immersive, feature-rich surround sound experience from two speakers, complete with rich bass, high frequency detail and clear dialog.



ENERGY STAR® is a joint program of the U.S. Environmental Protection Agency and the U.S. Department of Energy helping us all save money and protect the environment through energy efficient products and practices.

Consumer Notice:

This TV has been set to maximize energy efficiency while delivering the best possible picture using the factory installed home mode settings. Changing or enabling other features in this TV (e.g. brightened backlighting) will possibly increase energy consumption beyond the original ENERGY STAR® qualified limits.



LED backlighting technology uses less energy when compared with a standard CCFL backlighting LCD television of the same screen size. Actual energy savings will vary depending on the screen size.

FILM FRESH Film Fresh and the Film Fresh logo are registered trademarks of Film Fresh Inc.

* Film Fresh is supported in 50PFL3908, 46PFL3908, 40PFL4908, 39PFL2908, 32PFL4908, 29PFL4908 only.



VUDU™ is a trademark of VUDU, Inc.



DLNA®, the DLNA Logo and DLNA CERTIFIED® are trademarks, service marks, or certification marks of the Digital Living Network Alliance.



Netflix and the Netflix logo are trademarks or registered trademarks of Netflix, Inc.



YouTube and the YouTube logo are trademarks of Google Inc.



CloudTV™ (CloudTV™ by ActiveVideo®) technology provided under license from ActiveVideo Networks, Inc. U.S. and Foreign Patents apply. CloudTV™ and the "CloudTV™" logo are proprietary trademarks of ActiveVideo Networks, Inc.



PANDORA, the PANDORA logo, and the Pandora trade dress are trademarks or registered trademarks of Pandora Media, Inc. Used with permission.



vTuner is a trademark of Nothing Else Matters Software, Ltd.

* vTuner is supported in 50PFL3908, 46PFL3908, 40PFL4908, 39PFL2908, 32PFL4908, 29PFL4908 only.



Hulu, the Hulu logo, www.hulu.com, and other Hulu marks, graphics, logos, scripts, and sounds are trademarks of Hulu. None of the Hulu trademarks may be copied, downloaded, or otherwise exploited.



Portico, Portico TV and the Portico logo are service marks of Net2TV Corporation.



The Wi-Fi CERTIFIED Logo is a certification mark of the Wi-Fi Alliance.



CinemaNow and the CinemaNow logo are trademarks of BestBuy Stores L.P. and BestBuy Canada LTD.

* CinemaNow is supported in 50PFL3908, 46PFL3908, 40PFL4908, 39PFL2908, 32PFL4908, 29PFL4908 only.



Wireless connection... Easily browse everything from the internet on your TV.

Portions of this software are copyright © The FreeType Project (www.freetype.org).

The American Academy of Pediatrics discourages television viewing for children younger than two years of age.

2 Important

Positioning the TV

- Large screen TVs are heavy. 2 people are required to carry and handle a large screen TV.
- Make sure to hold the upper and bottom frames of the unit firmly as illustrated.
- Install the unit in a horizontal and stable position.
- Do not install the unit in direct sunlight or in a place subject to dust or strong vibration.
- Depending on the environment, the temperature of this unit may increase slightly. This is not a malfunction.
- Avoid a place with drastic temperature changes.
- Do not place anything directly on top or bottom of the unit.
- Depending on your external devices, noise or disturbance of the picture and / or sound may be generated if the unit is placed too close to them. In this case, please ensure enough space between the external devices and the unit.
- Do not insert the AC power cord into the power socket outlet before all the connections are made.
- Ensure that you always have easy access to the AC power cord or plug to disconnect the TV from the power.
- Before you move the TV, disconnect attached cables to prevent damage to connectors.
- Be sure to unplug the AC power cord from the AC outlet before moving or carrying the unit.

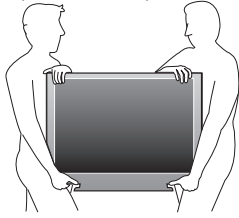

Regulatory notices

Do not place the unit on the furniture that is capable of being tilted by a child and an adult leaning, pulling, standing or climbing on it. A falling unit can cause serious injury or even death.

This apparatus should not be placed in a built-in installation such as a bookcase or rack unless proper ventilation is provided. Make sure to leave a space of 4 inches (10cm) or more around this apparatus.

Press  to turn the unit on and go into standby mode. To completely turn Off the unit, you must unplug the AC power cord. Disconnect the AC plug to shut the unit off when trouble is found or not in use. The AC plug shall remain readily available.

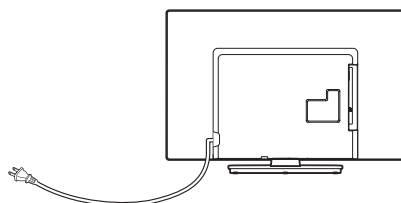

AC plug

Never use a gas duster on this TV. The gas trapped inside of this unit may cause ignition and explosion.

CAUTION: Danger of explosion if battery is incorrectly replaced. Replace only with the same or equivalent type.

WARNING: Batteries (battery pack or battery installed) shall not be exposed to excessive heat such as sunshine, fire or the like.

WARNING: To prevent injury, this apparatus must be securely attached to the furniture / wall in accordance with the instructions. Tipping, shaking, or rocking the unit may cause injury / death.

Environmental care



The packaging of this product is intended to be recycled.

Contact your local authorities for information about how to recycle the packaging.

For product recycling information, please visit - www.recycle.philips.com

End of life directives



Philips pays a lot of attention to produce environment-friendly products in green focal areas. Your new TV contains materials which can be recycled and reused. At the end of its life, specialized companies can dismantle the discarded TV to concentrate the reusable materials and to minimize the amount of materials to be disposed of. Please ensure you dispose of your old TV according to local regulations.

Disposal of used batteries

The batteries supplied do not contain the heavy metals mercury and cadmium. Nevertheless, in many areas batteries may not be disposed of with your household waste. Please ensure you dispose of batteries according to local regulations.

3 Get started

Features

- DTV / TV / CATV**
 You can use your remote control to select channels which are broadcast in Digital format and conventional Analog format. Also, cable subscribers can access their cable TV channels.
- Information display**
 You can display the title, contents and other information of the current program on the TV screen.
- AutoProgram**
 This unit automatically scans and memorizes channels available in your area, eliminating difficult setup procedures.
- Net TV**
 This unit lets you enjoy Internet services. Use the remote control to browse the Net TV pages. You can play movies and much more, all from your TV screen.
- Child lock**
 This feature allows you to block children's access to inappropriate programs.
- Closed Caption decoder**
 Built-in Closed Caption decoder displays text for Closed Caption supported programs.
- MTS / SAP tuner**
 Audio can be selected from the remote control.
- Auto Standby**
 If there is no Input signal and no operation for 15 minutes, the unit will go into Standby mode automatically.
- Sleep timer**
 You can set the unit to go into Standby mode after a specific amount of time.
- Choices for on-screen language**
 Select your on-screen language: English, Spanish or French.
- Stereo sound function**
- PLL frequency synthesized tuning**
 Provides free and easy channel selection and lets you tune directly to any channel using the number and decimal point "." buttons on the remote control.
- Various adjustment for picture and sound**
 Customizes image quality suitable for your room and sets your sound preference.
- EasyLink via HDMI link**
 EasyLink allows your other HDMI link devices to be controlled by the HDMI cable connected to your TV.
- HDMI Input**
- HDMI-DVI Input**
 If your video device has DVI Output jack, use an HDMI-DVI conversion cable to connect the unit.
- Component Video Input**
- PC Input**
- AV Input**
- USB terminal**
 The picture (JPEG), music (MP3) and video files stored on a USB Memory Stick can be played back on this unit.
- Digital Audio Output**
- Headphone Audio Output**

Supplied accessories

User Manual



Quick Start guide



Remote Control and batteries (AAA, 1.5V x 2)

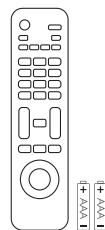

TV base and screws

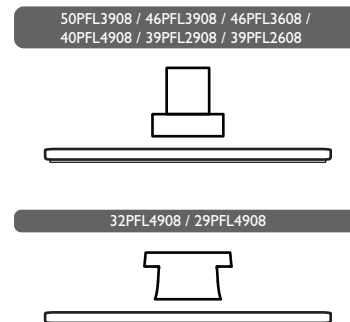

Screws packed with this unit.

| Model | Quantity | Size |
|-----------------------------------|----------|--------------------|
| 50PFL3908 / 46PFL3908 / 46PFL3608 | 8 | M4 x 0.472" (12mm) |
| 40PFL4908 / 39PFL2908 / 39PFL2608 | 3 | M4 x 0.393" (10mm) |
| | 4 | M4 x 0.787" (20mm) |
| 32PFL4908 / 29PFL4908 | 3 | M4 x 0.984" (25mm) |

Note

- If you lose the screws, please purchase the above-mentioned Phillips head screws at your local store.
- If you need to replace these accessories, please refer to the part name or No. with the illustrations and call our toll free customer support line found on the cover of this User Manual.

When using a universal remote control to operate this unit.

- Make sure the component code on your universal remote control is set to our brand. Refer to the instruction book accompanying your remote control for more details.
- We do not guarantee 100% interoperability with all universal remote controls.

Symbols used in this User Manual

The following is the description for the symbols used in this User Manual. Description refers to:

Digital TV operation



Analog/Cable TV operation

- If neither symbol appears, the operation is applicable to both.

Stand assembly

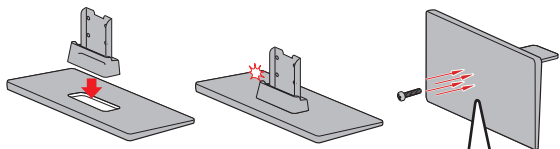
50PFL3908 / 46PFL3908 / 46PFL3608 / 40PFL4908 / 39PFL2908 / 39PFL2608



 × 4 [50PFL3908 / 46PFL3908 / 46PFL3608]
 × 3 [40PFL4908 / 39PFL2908 / 39PFL2608:
 M4 × 0.393" (10mm)]

32PFL4908 / 29PFL4908

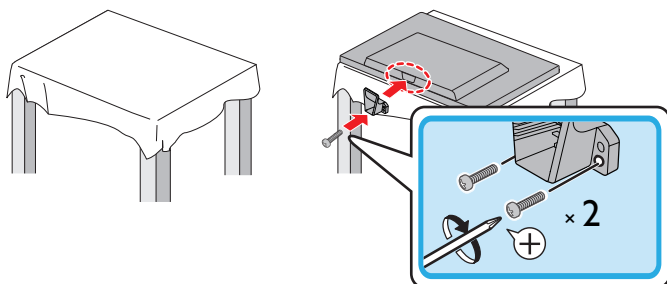

Attaching the base

You must attach the base to the unit to have it as a table top unit. Be sure the front and rear of the base match the proper direction. For large screen TVs, at least 2 people are required for these steps.

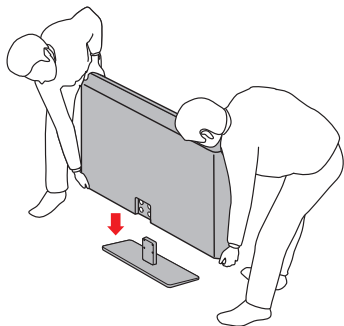

50PFL3908 / 46PFL3908 / 46PFL3608 / 40PFL4908 / 39PFL2908 / 39PFL2608

1

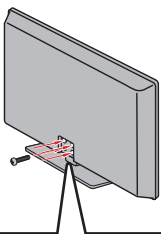

2



 × 4 [50PFL3908 / 46PFL3908 / 46PFL3608]
 × 4 [40PFL4908 / 39PFL2908 / 39PFL2608:
 M4 × 0.787" (20mm)]

32PFL4908 / 29PFL4908

1

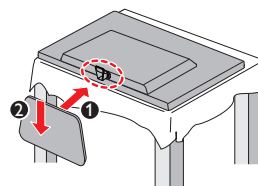

2

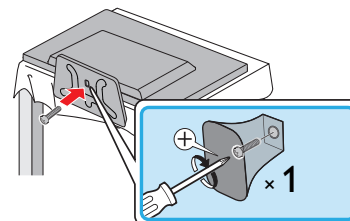

3

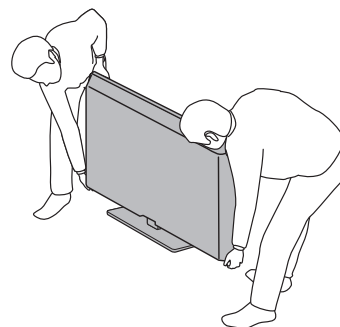

Note

- Make sure to use a table which can support the weight of this unit and is larger than this unit.
- Make sure the table is in a stable location.
- When attaching the base, ensure that "FRONT" with "arrow" written on the bottom of the base is downward.
- When attaching the base, ensure that all screws are tightly fastened. If the base is not properly attached, it could cause the unit to fall, resulting in injuries as well as damage to the unit.
- To remove the base from this unit, unscrew the Phillips head screws in step 2. Be careful not to drop the base when you remove it.

Managing cables

Route your antenna cable and all other cables through the cable management tie* at the back of the TV.

The holder helps keep your cables tidy and easily manageable.

- 1 Attach the cable management tie as illustrated below.

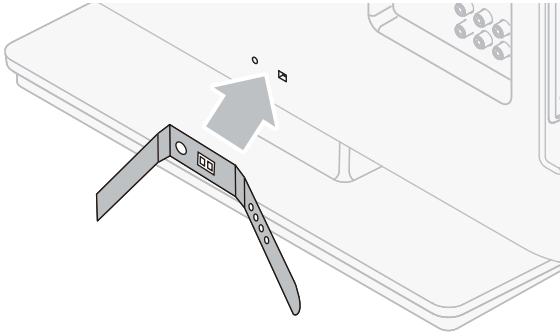

- 2 Pass cables through the cable management tie to avoid tangles.

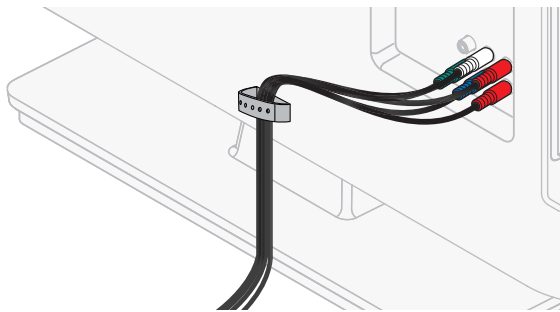

* The cable management tie is not supplied with your TV. If you would like this part, please call our toll free customer support line found on the cover of this User Manual, and it will be sent to you for free of charge.

Installing the remote control batteries

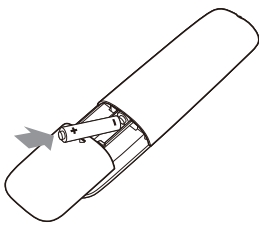

- 1 Slide the battery cover off the back of the remote control.
- 2 Insert the 2 supplied batteries (AAA, 1.5V). Be sure the + and - ends of the batteries line up with the markings inside the case.
- 3 Slide the cover back into position.

Note

- Remove the batteries if not using the remote control for an extended period of time.

Remote control

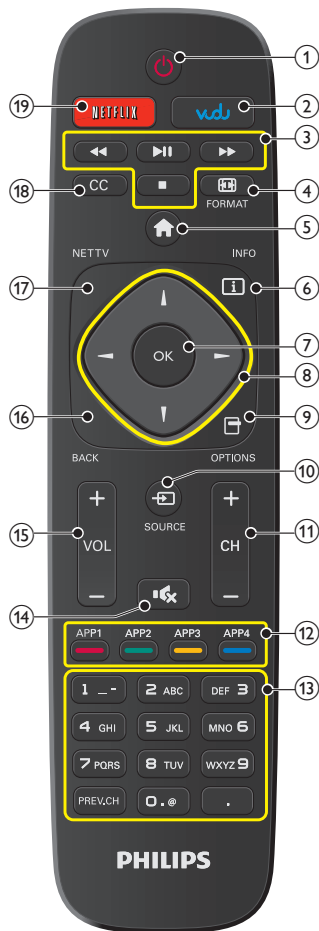

- ① **⏻ (POWER)**
Turns the TV On from Standby or Off to Standby.
 - ② **VUDU**
Access to VUDU directly.
 - ③ **EasyLink(HDMI CEC) buttons**
◀ / ▶ Searches Backward or Forward through the disc.
▶▶ Starts, pauses or resumes playback.
■ Stops the Disc playback.
 - ④ **⏮ FORMAT**
Adjusts the Picture size on the TV screen.
 - ⑤ **🏠 (MENU)**
Displays the main menu.
 - ⑥ **ℹ INFO**
Displays Information about the current program.
 - ⑦ **OK**
Press to decide the command of setting when the Home menu is displayed.
 - ⑧ **▲ ▼ ◀ ▶ (NAVIGATION buttons)**
Moves the cursor; Selects the On-screen Menu items.
 - ⑨ **☰ OPTIONS**
Displays a list of menu items applicable to the highlighted object or screen.
 - ⑩ **📺 SOURCE**
Selects Connected devices.
 - ⑪ **CH + / -**
Selects a Channel.
 - ⑫ **Apps (APP1 / APP2 / APP3 / APP4) buttons**
Works as direct access to user specified net apps.
 - ⑬ **0 - 9 (NUMBER buttons)**
Used to enter a Channel / Program number.
• **(DOT)** Use with **0-9** to select digital channels. For example, to enter 2.1, press
-
- PREV.CH** Returns to the previously viewed Channel.
- ⑭ **🔇 (MUTE)**
Turns the Sound On and Off.
 - ⑮ **VOL + / -**
Adjusts the Volume.
 - ⑯ **BACK**
Returns to the previous Menu operation.
 - ⑰ **NET TV**
Access to Net TV menu directly.
 - ⑱ **CC**
Displays the audio portion of programming as text superimposed over the video.
 - ⑲ **NETFLIX**
Access to Netflix directly.

Control panel

50PFL3908 / 46PFL3908 / 46PFL3608

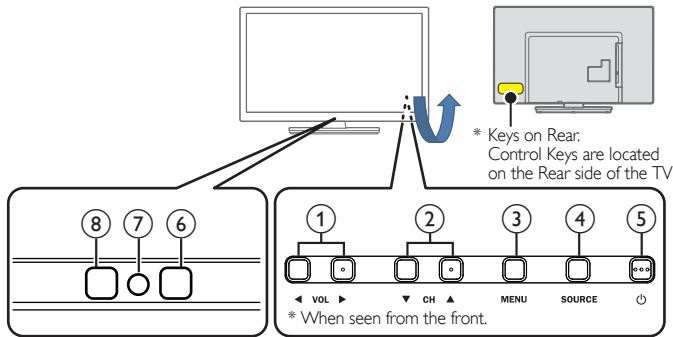

40PFL4908 / 32PFL4908 / 29PFL4908

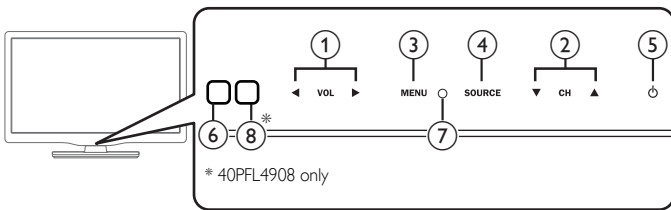

39PFL2908 / 39PFL2608

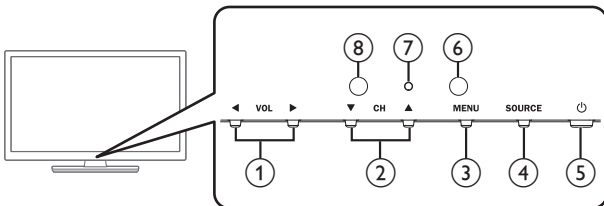

- ① **VOL ◀/▶**
Adjusts the Volume. In the Menu screen, moves the Cursor Left (◀) / Right (▶).
VOL ◀ : Volume Down
VOL ▶ : Volume Up
- ② **CH ▲/▼**
Selects a Channel. In the Menu screen, moves the Cursor Up (▲) / Down (▼).
- ③ **MENU**
Opens the Main On-screen Menu.
- ④ **SOURCE**
Selects Connected devices.
- ⑤ **⏻ (POWER)**
Turns the TV On and Off.
- ⑥ **Remote Control Sensor**
Receives IR signal from Remote control.
- ⑦ **Power On / Standby Indicator**
(On : lights in white, Standby : no light)
- ⑧ **Ambient Light Sensor**
Alters the brightness of the TV screen automatically by detecting your room lighting level. Do not block this Light Sensor window to allow proper operation.

Terminals

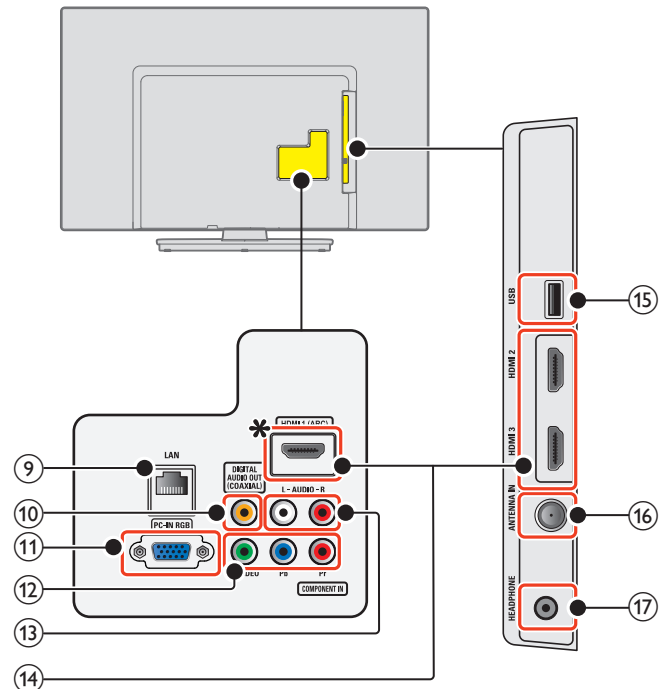

- ⑨ **Ethernet port**
For Internet connection using an Ethernet cable with an RJ-45 connector.
- ⑩ **Digital Audio Output jack**
Digital Audio (S/PDIF) Output to home theaters and other Digital Audio systems.
- ⑪ **PC Input jack**
VGA cable connection for PC.
- ⑫ **Component (Y/Pb/Pr) / Composite Video (VIDEO) Input jacks for VIDEO**
Composite Video Input (VIDEO) jack is a shared jack with Component Video Input (Y) jack.
- ⑬ **Analog Audio (L/R) Input jacks**
Connect Analog Audio signals from;
 - HDMI-DVI / Analog Audio (L/R) jacks signal
 - Component Video / Analog Audio (L/R) jacks signal
 - Composite Video / Analog Audio (L/R) jacks signal
 - PC Connection / Analog Audio (L/R) jacks signal with Stereo mini 3.5mm plug Audio cable on PC
- ⑭ **HDMI Input jack(s)**
Digital audio and video Input from high definition Digital devices such as DVD / Blu-ray disc players, cable / satellite set-top boxes, PC's.
- * For HDMI 1 only
In addition to normal HDMI and HDMI-DVI functionality, it outputs TV Audio to an HDMI-ARC-compliant device, such as a home theater system.
- ⑮ **USB terminal**
Data Input from USB Memory Stick only.
Do not connect any device to this terminal such as; Digital camera, keyboard, mouse, etc.
- ⑯ **75 ohm Cable / Antenna connection**
Signal Input from an antenna or cable / satellite set-top boxes.
- ⑰ **Headphone Audio Output jack**
Headphone 3.5mm stereo jack for personal listening.

Connecting the antenna or the cable

Be sure your antenna or other device is connected properly before plugging in the AC power cord.

If you connect to an antenna through RF cable

Any DTV programs that are broadcasted in your area can be received for free through an antenna connection.

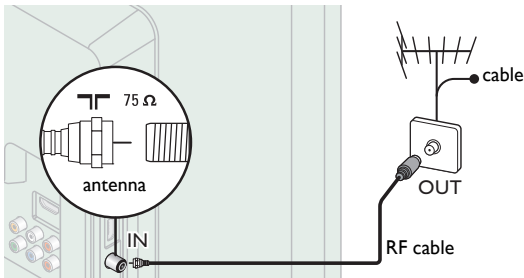

If you connect a set-top box through RF cable

If the TV is connected to a cable / satellite set-top box via a coaxial connection, set the TV to channel 3, 4 or the channel specified by the service provider.

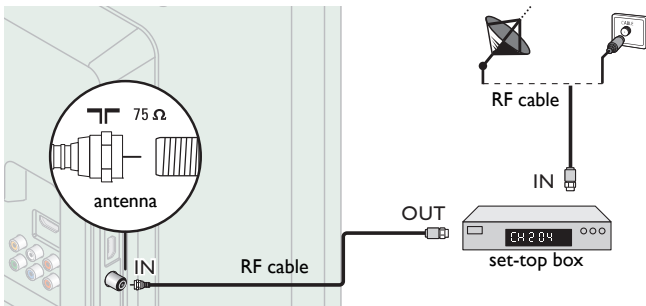

If you connect a set-top box through HDMI

If the TV is connected to a cable / satellite set-top box via HDMI, make sure you select the correct Source by using SOURCE.

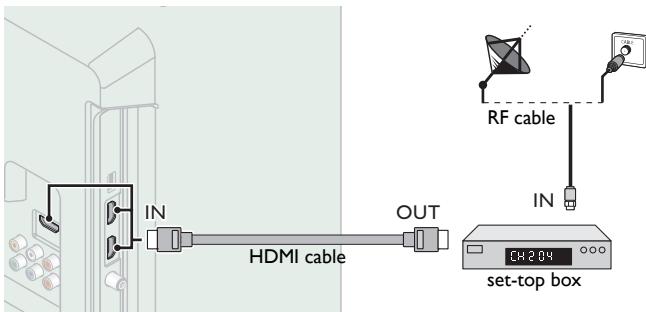

If you connect a set-top box through Component Video Input

If the TV is connected to a cable / satellite set-top box via Component Video Input, make sure you select the correct Component Video Source by using SOURCE.

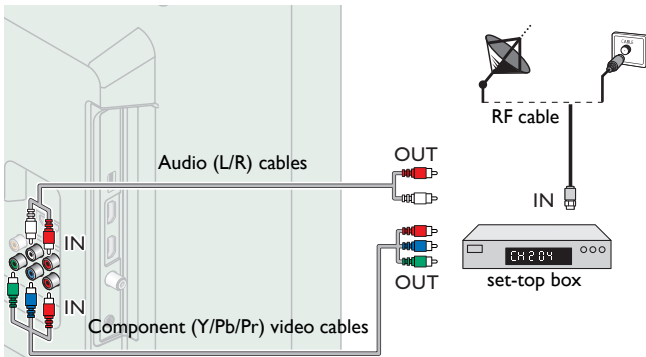

Connecting a set-top box, Blu-ray disc / DVD recorder via composite connectors and Analog Audio

Do not place your recorder too close to the screen because some recorders can be susceptible to signals.

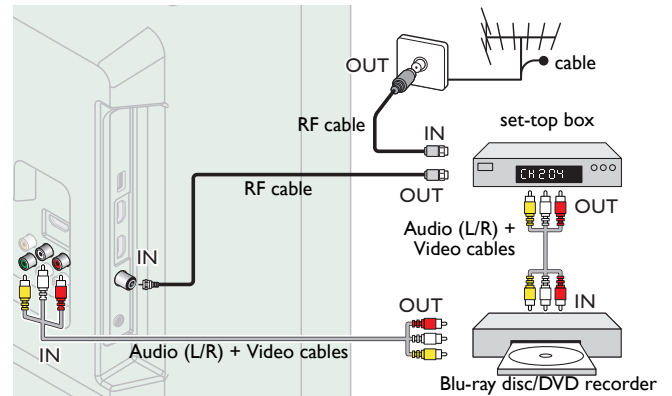

Note

- If you have any question about the DTV's antenna, visit www.antennaweb.org for further information.
- Depending on your antenna system, you may need different types of combiners (mixers) or separators (splitters) for HDTV signal. The minimum RF bandpass on these devices is 2,000MHz or 2GHz.
- For your safety and to avoid damage to this unit, please unplug the RF coaxial cable from the antenna Input jack before moving the unit.
- If you did use an antenna to receive Analog TV, it should also work for DTV reception. Outdoor or attic antennas will be more effective than a set-top box or inside antenna.
- To Turn On your reception source easily between antenna and cable, install an antenna selector.
- If you are not receiving a signal from your cable service, contact the Cable provider.
- Only the left loudspeaker reproduces sound for mono equipment. Use a mono to stereo adapter (not supplied) for sound reproduction via all internal loudspeakers.

Plugging in the AC power cord

Make sure that the AC power cord must be plugged to an AC outlet after all the necessary connections are made.

Caution

- Do not connect the AC power cord to a power supply outside the indicated voltage of this unit (AC 120V).
- Connecting the AC power cord to a power supply outside of this range may result in fire, smoke, unit failure or electrical shock.

Note

- Each time you plug in the AC power cord, no operations will be performed for a few seconds. This is not a malfunction.

No supplied cables are used with these connections:

- Please purchase the necessary cables at your local store.

Before you connect AC power cord:

Be sure other devices are connected properly before plugging in the AC power cord.

Selecting your connection quality

HDMI - Highest quality

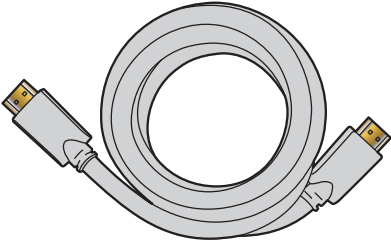

Supports high-definition Digital signals and gives highest picture and sound quality. Video and audio signals are combined in one cable. You must use HDMI for full high-definition video and to enable Philips EasyLink (HDMI CEC).

Note

- Philips HDMI supports HDCP (High-bandwidth Digital Contents Protection). HDCP is a form of Digital Rights Management that protects high definition content in Blu-ray discs or DVDs.
- The HDMI-ARC connector on the TV features HDMI-ARC functionality. This allows output of TV Audio to an HDMI-ARC-compliant device.

Component (Y Pb Pr) - High quality

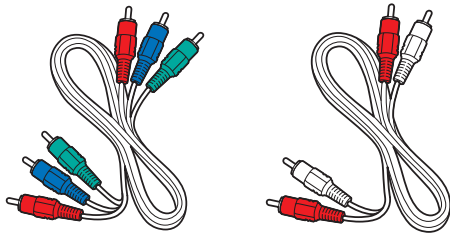

Supports high-definition Analog signals but gives lower picture quality than HDMI. Component (Y/Pb/Pr) Video cables combine red / green / blue video cables with red / white audio (L/R) cables. Match the cable colors when you connect to the TV.

Composite - Basic quality

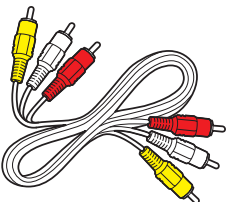

For analog connections. Composite Video / Audio Analog cable usually combine a yellow video cable with red / white audio (L/R) cables. With this unit, yellow cable must be connected to Y (green) jack of Component Video Input jacks.

Connecting your devices

HDMI Digital connection

HDMI connection offers the highest picture quality. HDMI (High-Definition Multimedia Interface) transports high definition Digital video and multi-channel Digital Audio through a single cable.

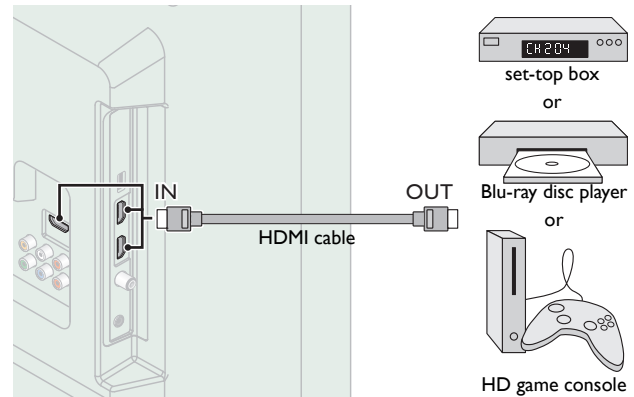

HDMI-DVI connection

This unit can be connected to your device that has a DVI terminal. Use an HDMI-DVI conversion cable for this connection and it requires audio cable for Analog Audio signal as well.

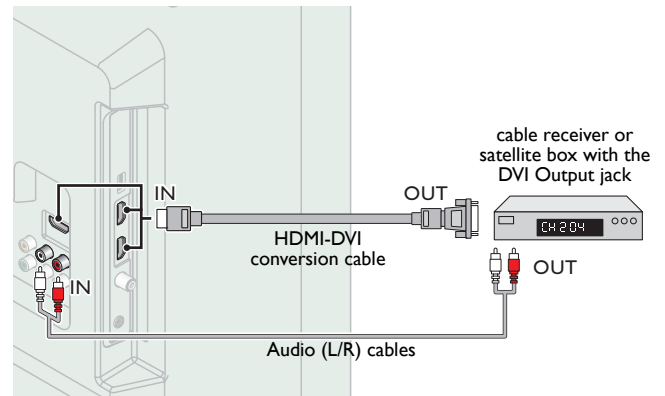

Note

- Use an HDMI cable with the HDMI logo (a certified HDMI cable). High Speed HDMI cable is recommended for the better compatibility.
- For HDMI connection**
- The unit accepts 480i / 480p / 720p / 1080i, 1080p 24/30/60Hz of video signals, 32kHz / 44.1kHz and 48kHz of audio signals.
 - This unit accepts 2 channel Audio signal (LPCM) only.
 - This unit accepts only signals in compliance with EIA861.
- For HDMI-DVI connection**
- The unit accepts 480i, 480p, 720p, 1080i and 1080p video signals.
 - HDMI-DVI connection requires separate audio connections as well and the audio signals are output as Analog (L/R) Audio.
 - DVI does not display 480i image which is not in compliance with EIA/CEA-861/861B.

Continued on next page.

HDMI-ARC connection

HDMI-ARC allows you to use EasyLink to output TV Audio directly to a connected Audio device, without the need for an additional Digital Audio cable.

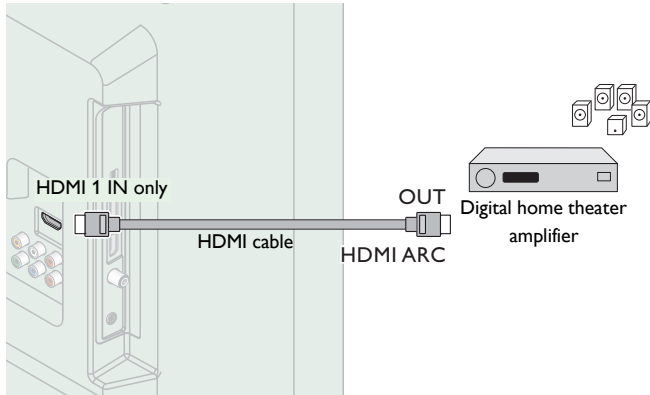

Note

- The HDMI 1 connector is HDMI Audio Return Channel (ARC) compliant. Use it to output Digital Audio to an HDMI home theater system.
- Be sure that the device is HDMI CEC and ARC compliant and that the TV is connected to the device using an HDMI cable attached to HDMI-ARC connectors.

Component Analog Video Connection

Component Analog Video connection offers better picture quality for video devices connected to the unit.

If you connect to the unit's Component Video (Y/Pb/Pr) Input jacks, connect Analog Audio cables to the Analog Audio (L/R) Input jacks.

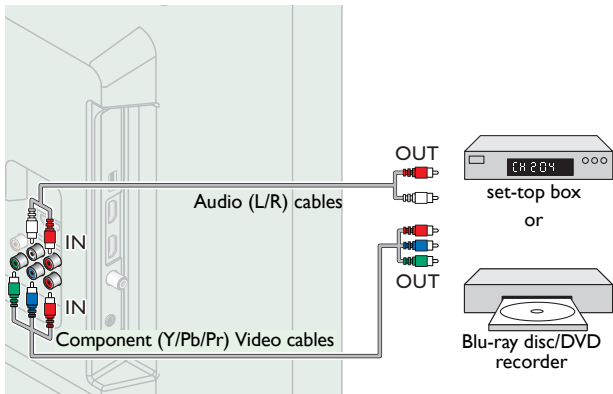

Note

- The unit accepts 480i / 480p / 720p and 1080i of video signals for this connection.

Composite Analog Video Connection

Composite Analog Video connection offers standard picture quality for video devices connected to the unit.

If you connect to the unit's Composite Video (Y/VIDEO) Input jack, connect audio cables to the Audio (L/R) Input jacks. When the Audio is monaural, then only connect to the Audio L Input jack.

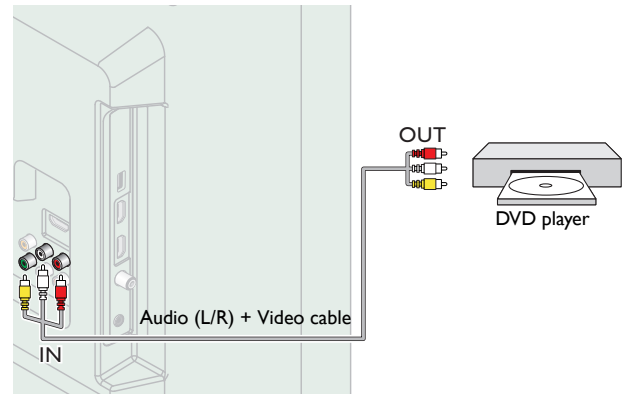

Note

- With this unit, yellow cable must be connected to Y (green) jack of Component Video Input jacks.
- Whenever you connect to the Composite Video Input jack (Y/VIDEO), you must disconnect the Component Video Input jacks (Pb and Pr). If you leave those jacks connected, it may cause of an unstable picture.
- Only the left loudspeaker reproduces sound for mono equipment. Use a mono to stereo adapter (not supplied) for sound reproduction via all internal loudspeakers.

Connecting the TV to the Internet using an Ethernet cable

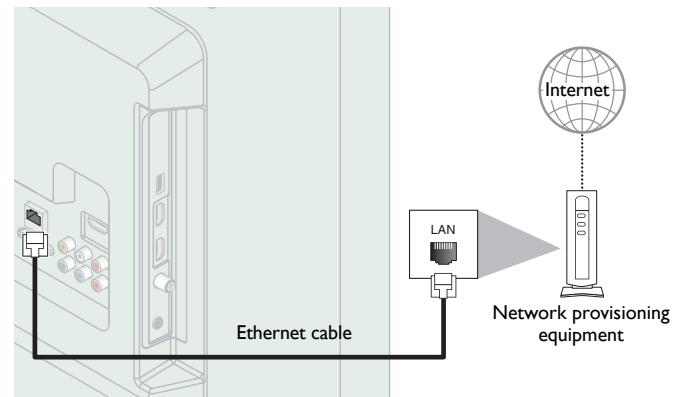

Note

- Please purchase shielded Ethernet cables at your local store and use them when you connect to network equipment.
- After connecting an Ethernet cable, set up necessary network settings. **Network → p.37**
- Do not insert any cable other than an Ethernet cable to the Ethernet port to avoid damaging the unit.
- If your telecommunications equipment (modem, etc.) does not have broadband router functions, connect a broadband router.
- If your telecommunications equipment (modem, etc.) has broadband router functions but there is no vacant port, use a hub.
- For a broadband router, use a router which supports 10BASE-T / 100BASE-TX.
- Do not connect your PC directly to the Ethernet port of this unit.

Continued on next page.

Connecting the TV to the Internet using a wireless LAN

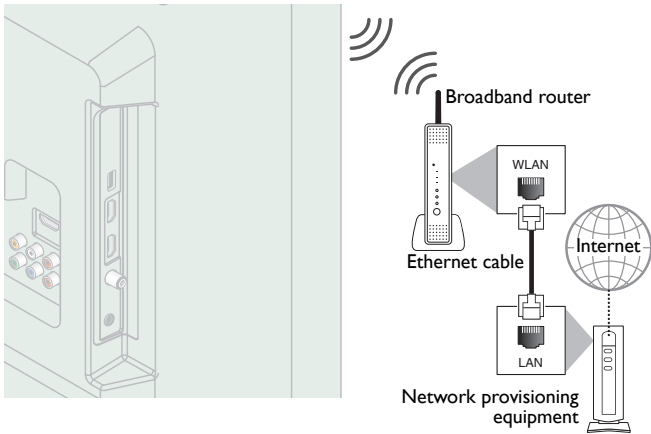

Note

- After you made the wireless connection, set up necessary network settings. **Network** → p.37
- Use a Wireless LAN Access Point (AP) (e.g. wireless router) which supports IEEE 802.11 b/g/n. (n is recommended for stable operation of the wireless network)
- This unit does not support Ad-hoc mode.
- Other radio devices or obstacles may cause interference to the wireless network connection.

Digital Audio Output Connection

If you connect this unit to an external Digital Audio device, you can enjoy multi-channel audio like 5.1ch Digital broadcasting sound. Use a Digital Audio coaxial cable to connect the unit to external Digital Audio devices.

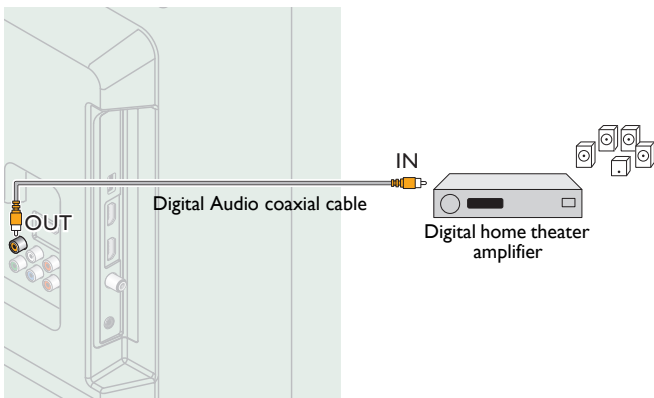

PC connection

HDMI connection

This unit can be connected to your PC that has a HDMI terminal. Use an HDMI cable for this Digital connection.

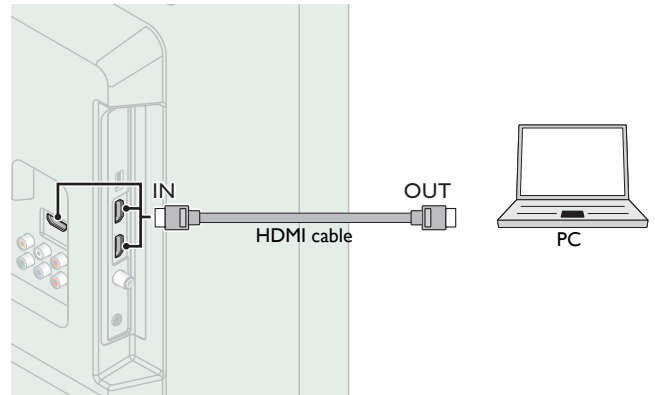

HDMI-DVI connection

This unit can be connected to your PC that has a DVI terminal. Use an HDMI-DVI conversion cable for this Video Digital connection and it requires Stereo mini 3.5mm plug Audio cable for Analog Audio signal as well.

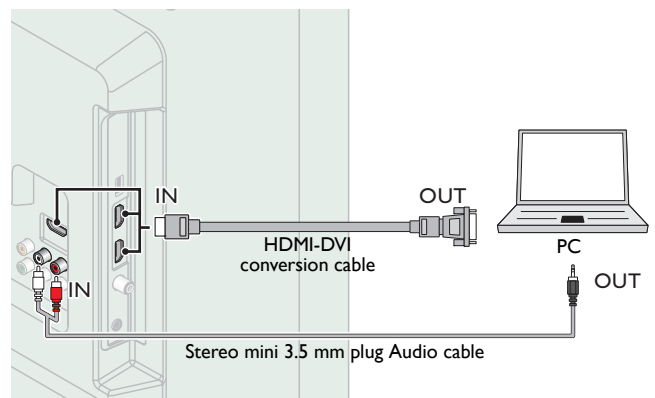

VGA connection

This unit is equipped with a PC Input jack. If you connect this unit to your PC, you can use this unit as a PC monitor. Use a VGA cable for this Video connection and it requires a Stereo mini 3.5mm plug Audio cable for Analog Audio signal as well.

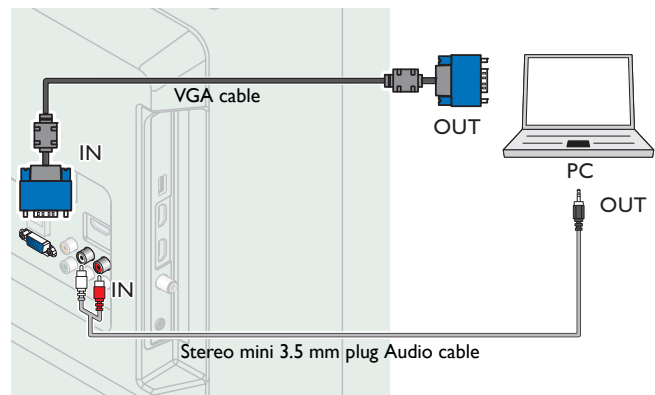

Continued on next page.

The following video signals can be displayed:

| Format | Resolution | Refresh rate |
|--------|---------------|--------------|
| VGA | 640 × 480 | 60Hz |
| SVGA | 800 × 600 | |
| XGA | 1,024 × 768 | |
| WXGA | 1,280 × 768 | |
| | 1,360 × 768 | |
| FHD* | 1,920 × 1,080 | |

Other formats or non-standard signals will not be displayed correctly.

* 50PFL3908 / 46PFL3908 / 46PFL3608 / 40PFL4908 / 39PFL2908 / 39PFL2608 only.

Note

- Please purchase the VGA cable or HDMI-DVI conversion cable that has a ferrite core.
- The following operations may reduce noise.
 - Attach a ferrite core to the AC power cord of your PC.
 - Unplug the AC power cord and use the built-in battery of your PC.
- Use an HDMI cable with the HDMI logo (a certified HDMI cable). High Speed HDMI cable is recommended for the better compatibility.
- The unit accepts 480i, 480p, 720p, 1080i and 1080p video signals.
- HDMI-DVI connection requires separate audio connections as well and the audio signals are output as Analog (L/R) Audio.
- DVI does not display 480i image which is not in compliance with EIA/CEA-861/861B.

USB Memory Stick

This unit offers easy playback of picture (JPEG), music (MP3) and video files.

Insert the USB Memory Stick into the USB terminal shown below.

USB → p.24

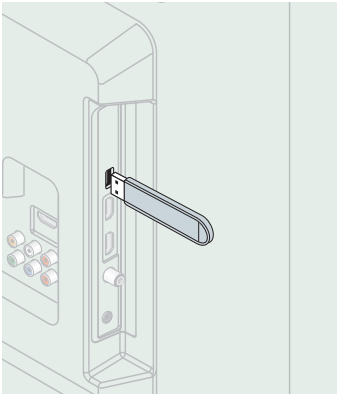

Note

- The unit recognizes only a USB Memory Stick.
- Do not use a USB hub or an extension cable to connect an external hard disk drive to the unit. (Not supported.)
- A USB Memory Stick is always inserted to this unit directly.
- A USB Memory Stick is not supplied with this unit.
- We do not guarantee that all USB Memory Sticks can be supported by this unit.
- Be sure to keep a backup copy of the original files on your device before you play them back on this unit. We have no responsibilities for damage or loss of your stored data.
- To protect your USB Memory Stick files from being erased place the write protect sliding tab in the protect position.
- When you are ready to remove a USB Memory Stick, set the unit to go into Standby mode to avoid any damage to your data and the unit.
- A USB Memory Stick that requires its own driver or the device with a special system such as fingerprint recognition are not supported.
- This unit is not allowed to use the USB Memory Stick which requires an external power supply (500mA or more).

*These operations are accessible by remote control.
Some may also be accessible by control panel on the main unit.*

Initial setup

This section will guide you through the unit's initial setting which includes selecting a language for your on-screen menu, country, location and AutoProgram, which automatically scans and memorizes viewable channels. You can also set the network connection in this setting.

Before you begin:

Make sure the unit is connected to antenna or cable.

- After making all the necessary connections, press to Turn On the unit.
 - It may take a few moments to Turn On the unit for the first time.
 - Initial setup** menu appears automatically after the unit is Turned On.
- Use to select the on-screen language, country, TV placement, location on the right side of the TV screen, then press **OK**.
 - You must set **Home** in location setting. Otherwise, **Picture** and **Sound** settings you adjusted will not be memorized after the unit goes into Standby mode.
- Use to select the signal type.
 - If the TV is connected to a cable box or satellite set-top box, select the 2nd one and skip to step 5.

| | |
|---|--------|
| To set up a TV signal from a cable TV wall jack or a standard TV antenna. | Select |
| To set up a TV signal from a cable TV box or satellite TV receiver. | Select |

- Use to select **Antenna** for TV channels or **Cable** for CATV channels, then press **OK**.

| | |
|---|---------|
| Make sure that you have attached your antenna or cable signal into the jack on the back of your TV labeled "ANTENNA IN". | Antenna |
| | Cable |
| | Skip |
| Now select either Antenna or Cable, using up/down key of the remote control. Once you have made your selection, press the OK button to proceed. | |

- When **Antenna** is selected, the TV detects antenna signals. It searches for DTV and Analog TV channels available in your area.
- When **Cable** is selected, the TV detects signals supplied by cable. It searches for DTV, Analog TV and Cable channels available in your area.
 - Autoprogram** will begin.

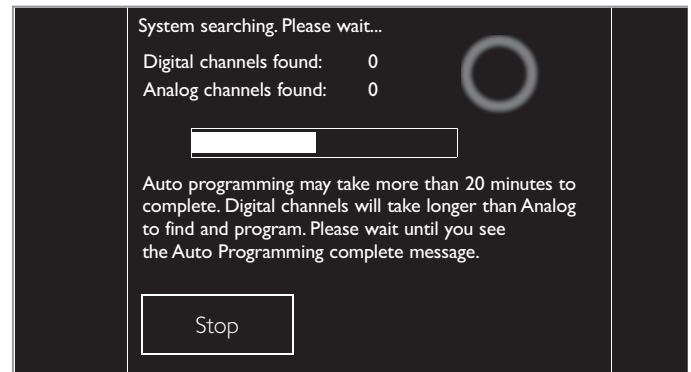

- After the channel installation is completed, Network setup screen will appear. Use to select **Wireless** or **Wired**, then press **OK**.

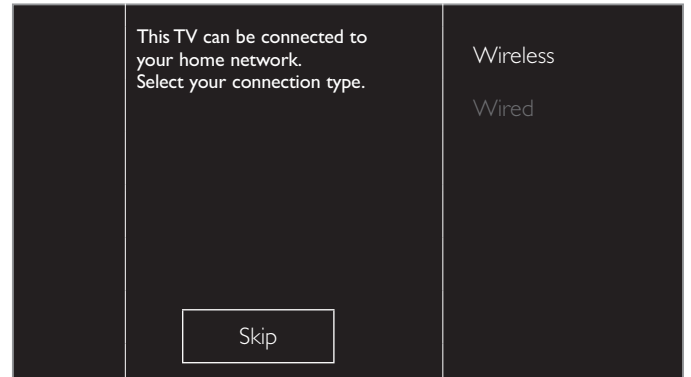

| | |
|-----------------|--|
| Wireless | If you have a Wireless router, select Wireless to connect to the Internet. |
| Wired | If you connect with an Ethernet cable, select Wired to connect to the Internet. |

- If you have a router with WPS function, select **Wireless** and use to select **Easy Connect**, then press **OK**.
- Follow the on-screen instructions to complete the installation.
 - When you select **On** in the selection screen of **Auto software update**. A message will appear if there is the latest software on the network server.
 - Use to select **Start**, then press **OK** to begin **Settings assistant**.

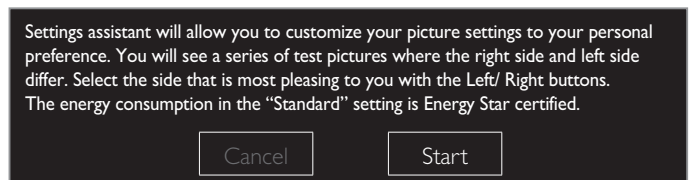

- Press or 5 times to select the side of the pictures that is the most pleasing to you, then press **OK**.

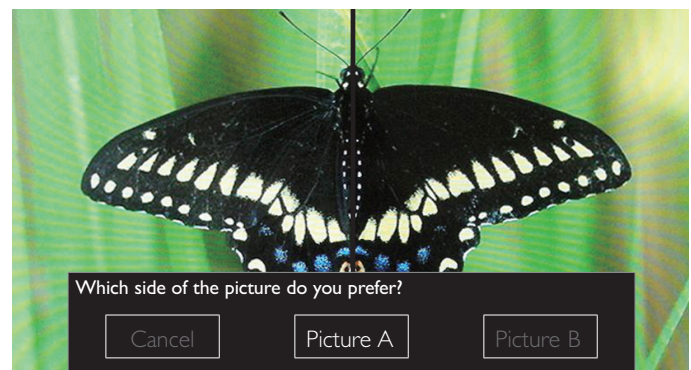

Continued on next page.

- 9 Use ◀▶ to select your preferred energy efficiency level, then press OK.

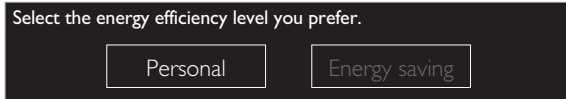

- 10 Use ◀▶ to select your preferred sound setting, then press OK.

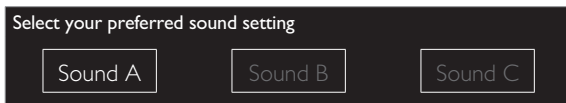

- 11 Press OK to finish **Settings assistant**.



- **Network updates** will appear after **Connection test** succeeds. Use ◀▶ to select **Yes**, then press **OK**.
- When the initial setup is completed, the lowest memorized channel with the confirmation message will be displayed on the TV screen.

Note

- If you are not receiving a signal from your cable service, contact the Cable provider.
- If you press ⏻ during autoprogram, this setup of TV channels will be cancelled.
- The initial AutoProgram function can be executed for either **Antenna** or **Cable** only once. When you change the connection (Antenna / Cable), select **Autoprogram** again. → p.34

After an initial setup is completed...

- If you want to scan the channels automatically again.
Autoprogram → p.34
- You can add the desired cable and Analog channels unmemorized by AutoProgram.
Weak channel installation → p.34
- If you want to change to another language.
Language → p.33
- If you want to change the country setting.
Country → p.45
- If you want to change the location setting.
Location → p.35
- If you want to change the network setting.
Network → p.37
- If you want to restore the picture and sound setting.
Settings assistant → p.27

4 Use your TV

Switching on your TV and putting it in Standby mode

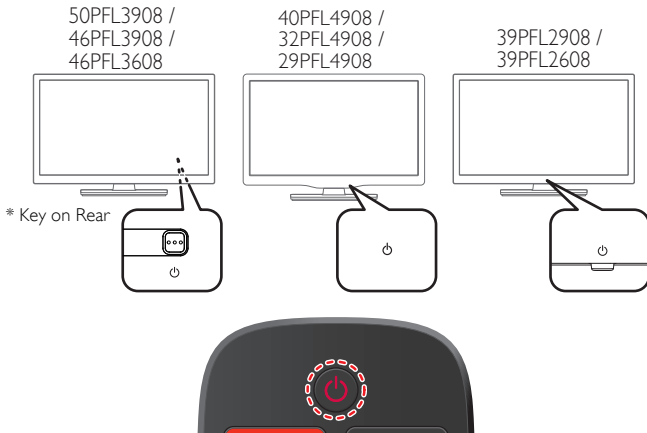

To Turn the TV On from Standby or Off to Standby

- Press (3 raised dots on the Rear panel or Front panel or the Remote control).

Note

- Energy consumption contributes to air and water pollution. When the AC power cord is plugged in, your TV consumes energy. Your TV has very low standby power consumption.

Adjusting volume

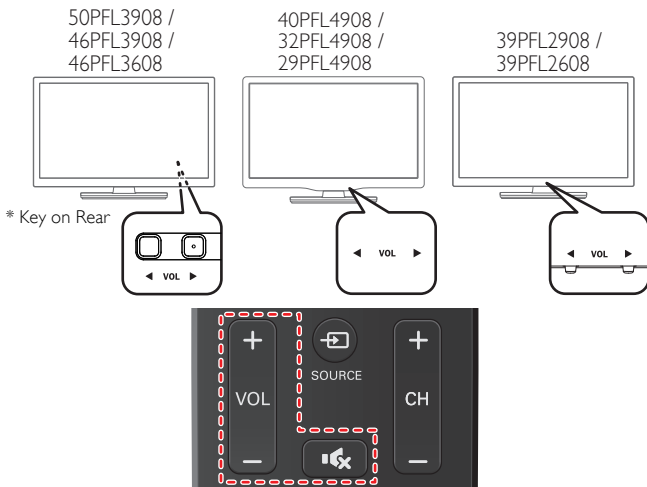

To decrease or increase volume

- Press / (1 raised dot on the Rear panel) or Front panel or press on the Remote control.
VOL : Volume Down
VOL : Volume Up

To mute or unmute sound

- Press on the remote control to mute the sound.
- Press again or to recover the original sound.

Switching channels

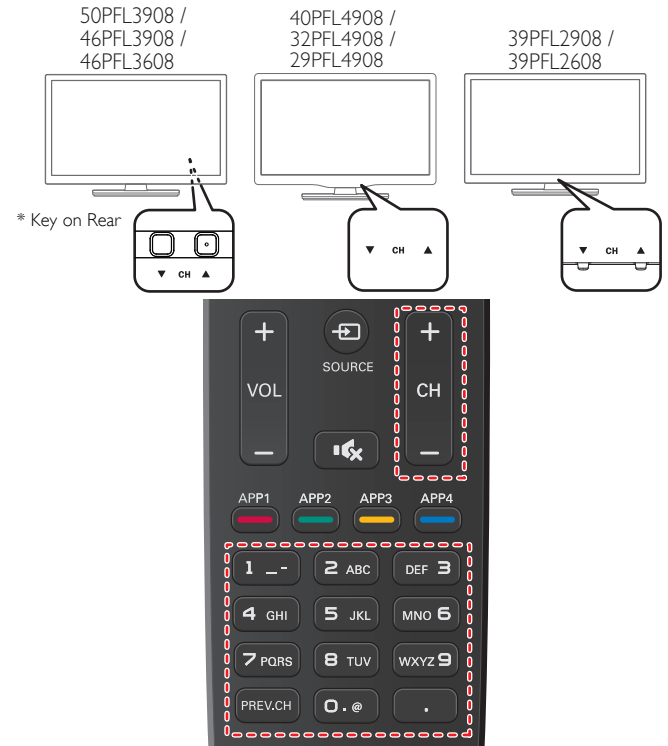

To select Channels by using CH / or CH + / -

- Press **CH** (Down) / **CH** (Up - 1 raised dot on the Rear panel or Front panel) or press **CH + / -** on the Remote control.

To select Channels by using the NUMBER buttons

Digital TV operation

- For Digital channels, press a number followed by a dot “.” and the corresponding sub channel number.
- When selecting Digital channel 11.1
Be sure to press before entering the subchannel number.



Analog/Cable TV operation

- When selecting cable or Analog channel 11



Press **PREV.CH** to return to the previously viewed channel.

Note

- To select the non-memorized channels, use the **NUMBER buttons**.
- Channel not available** or **No Signal** will appear on the TV screen after the subchannel broadcast is over.
- Audio Only** message will appear on the TV screen, when you receive only sound signal.

* On the 46" & 50" TV's All CONTROL Keys are located on the Rear (lower right) side of the unit as viewed from the Front.

Watching channels from an external device

Switching Each Input Mode can easily switch with the remote control between TV (DTV or Analog TV) and external devices when they are connected to the unit.

- 1 Turn On a set-top box or the connected device.
 - The picture from your set-top box or the connected device might appear automatically on the TV screen.

If the picture does not appear

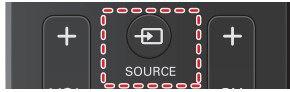

Press SOURCE repeatedly to select the set-top box or the connected device and wait a few seconds till the picture appears. e.g.)

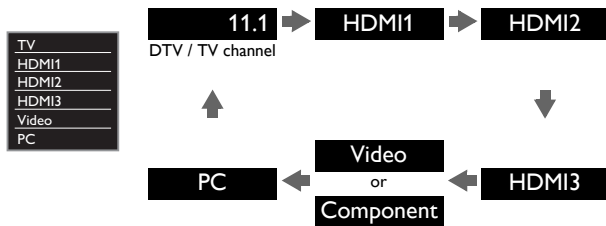

- Pressing reverses the direction of the Input modes.
- 2 Use the remote control of the set-top box or the connected device to select channels.

Access the Home menu

- 1 Press (MENU).



Guide to Home menu

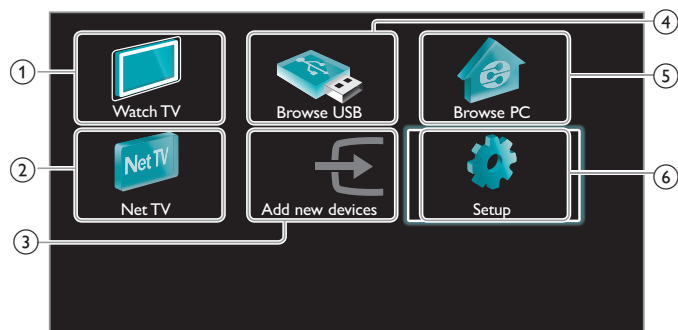

- ① **Watch TV:** Switches back to the antenna source if another source is selected.
- ② **Net TV:** Accesses Net TV menus.
- ③ **Add new devices:** Adds new devices to the Home menu.
- ④ **Browse USB:** Accesses USB menus.
- ⑤ **Browse PC:** Accesses DLNA menus.
- ⑥ **Setup:** Accesses menus that allow you to change picture, sound and other TV settings.

Note

- After selecting **Add new devices**, follow the on-screen instructions to select the correct device and connector.

Lock or unlock your device from the Home menu

This section describes how to lock or unlock specified device.

- 1 Press (MENU) on the remote control.
- 2 Use to select a device to lock or unlock.
- 3 Press OPTIONS on the remote control.
- 4 Use to select **Device lock** or **Device unlock**, then press **OK**.
 - If device lock is unlocked, **Device lock** will be displayed. If device lock is locked, **Device unlock** will be displayed and will be displayed at the top right of the device icons.
- 5 Enter your PIN. **Change PIN** → p.33
 - Once you have set PIN, PIN input menu does not appear after the unit is Turned on.

Enable or disable RC key forwarding from the Home menu

This section describes how to enable or disable RC key forwarding for a particular device.

- 1 Press (MENU) on the remote control.
- 2 Use to select a device to enable or disable RC key forwarding.
- 3 Press OPTIONS on the remote control.
- 4 Use to select **Enable RC key forwarding** or **Disable RC key forwarding**, then press **OK**.
 - If RC key forwarding is set to off, **Enable RC key forwarding** will be displayed. If RC key forwarding is set to on, **Disable RC key forwarding** will be displayed and will be displayed at the top right of the device icons.

Note

- This function is available only when your devices are connected to this unit through HDMI cables and assigned to an HDMI port (HDMI 1 to HDMI 3) with **Add new devices** in the Home menu.

Using auto mode

- 1 Press  **OPTIONS** and select **Auto picture** or **Auto sound** to set your TV to a predefined picture and sound setting.



- 2 Use **▲▼** to select one of the following settings:

| Auto picture | Auto sound | Description |
|-----------------------|--------------|--|
| Personal | | The customized settings you defined using the Picture and Sound menu |
| Standard | | For normal TV viewing |
| Vivid | | Enhanced picture contrast, sharpness and sound for viewing in a well-lit room |
| Sports | | Brilliant picture settings and clear sound for high action |
| Movie | | Deep picture and powerful sound settings for a cinematic experience |
| Game | - | Optimized for PCs and game consoles |
| Energy saving | - | Eco TV settings for low power consumption |
| Internet video | - | Optimized for low bitrate Internet video |
| - | Music | Optimized for music playback |
| - | News | Set the anchor's voice at a comfortable volume |

Switch to one of the channels on a list

- 1 Press **OK** to display the last list that you selected.
- 2 Use **▲▼** to select a channel, then press **OK**.
 - The TV switches to that channel.

Note

- Press **CH + / -** to select channels in a list or press the **NUMBER** buttons to select channels that are not in a list .

Create and use lists of favorite channels

You can create lists of your preferred TV channels so that you can find those channels easily.



Select a list of favorite channels

- 1 Press  **OPTIONS** and select **Favorites**.



- Your lists of favorite channels are displayed.
- 2 Use **▲▼** to select the desired list, then press **OK**.

Create or edit a list of favorite channels

- 1 Press  **OPTIONS** and select **Favorites**.
- 2 Use **▲▼** to select the desired list, then press **OK**.
- 3 Press  **OPTIONS** to enter edit mode.
 - A list of channels is shown.
- 4 Use **▲▼** to select the desired channel, then press **OK** to add or remove on the list of favorite channels.
 - indicates that the channel is added.
 - indicates that the channel is removed.
- 5 Press **⏠** (**MENU**) to exit.

Changing picture format

Display modes can be selected when your TV receives a 16:9 or 4:3 video signal.

Three types of display modes can be selected for a PC Input signal.

Press **FORMAT** repeatedly to switch the TV aspect ratio.



For 16:9 video signal

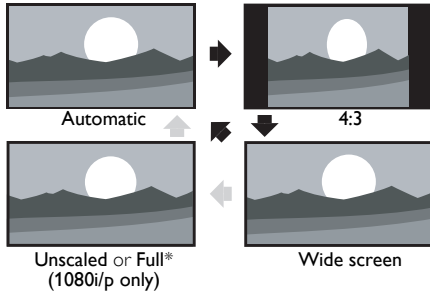

| | |
|---|--|
| Automatic | Other than DTV and HDMI connected devices, enlarges the picture to best fit the screen. DTV and HDMI connected devices display the picture at its original size. The subtitles may remain visible. |
| 4:3 | Displays a 16:9 picture at a 4:3 size; the picture is shortened horizontally. Sidebars appear on both edges of the screen. |
| Wide screen | Displays a 16:9 picture that is stretched horizontally and vertically. |
| Unscaled or Full* (1080i/p only) | Displays a 16:9 picture at its original size. |

* This part differs depending on the product you have.

- "Unscaled" for 50PFL3908, 46PFL3908, 46PFL3608, 40PFL4908, 39PFL2908, 39PFL2608.
- "Full" for 32PFL4908, 29PFL4908.

For 4:3 video signal

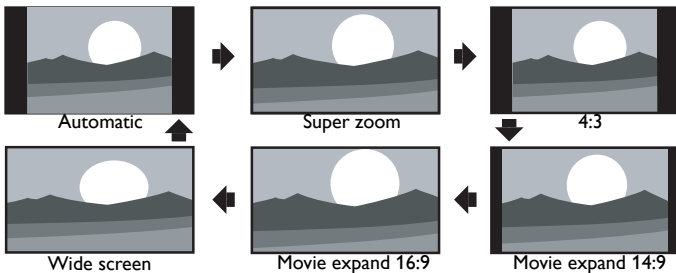

| | |
|--------------------------|--|
| Automatic | Other than DTV and HDMI connected devices, enlarges the picture to best fit the screen. DTV and HDMI connected devices display the picture at its original size. The subtitles may remain visible. |
| Super zoom | Displays a 4:3 picture at a 16:9 size; the picture is stretched horizontally and vertically and its left and right edges are enlarged. This crops out the top and bottom of the picture. |
| 4:3 | Displays a 4:3 picture at its original size. Sidebars appear on both edges of the screen. |
| Movie expand 14:9 | Displays a 4:3 picture at a 14:9 size; the picture is stretched horizontally and vertically. This crops out the top and bottom of the picture. Sidebars appear on both edges of the screen. |
| Movie expand 16:9 | Displays a 4:3 picture at a 16:9 size; the picture is stretched horizontally and vertically. This crops out the top and bottom of the picture. |
| Wide screen | Displays a picture that is stretched out of proportion to fill the screen. |

For PC Input signal

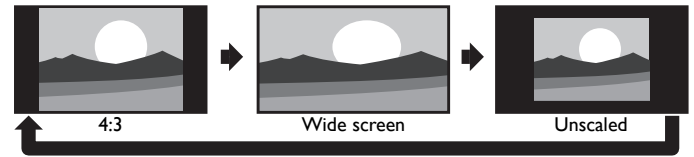

- This unit can also be connected to your PC that has a DVI terminal. Use an HDMI-DVI conversion cable for this Video connection and it requires Stereo mini 3.5mm plug Audio cable for Analog Audio signal as well.
- Refer to 16:9 video signal on this page if PC has HDMI Output.

| | |
|--------------------|--|
| 4:3 | Displays a proportionately stretched picture. Sidebars appear on both edges of the screen. |
| Wide screen | Displays a picture that is stretched out of proportion to fill the screen. |
| Unscaled | Displays a picture in its original size. |

TV screen information

You can display the currently selected channel or other information such as the aspect ratio on the TV screen.

In the Digital mode, the detailed broadcasting information for the current off-the-air channel such as program title and program guides are displayed.

1 Press **INFO**.

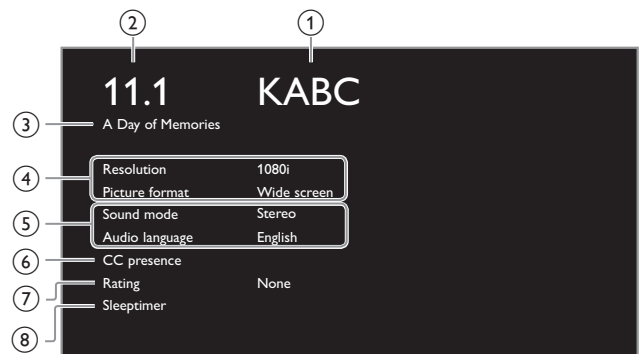

- 1 broadcast station
- 2 channel number / Input mode
Switching channels → p.20
Watching channels from an external device → p.21
- 3 program title (for DTV only)
- 4 program's image aspect ratio
Changing picture format → p.23
- 5 audio language (DTV) / audio mode (Analog TV)
Sound → p.29
- 6 CC (not available if Closed Caption is set to Off)
Caption settings → p.30
- 7 child lock rating
Child and ratings lock → p.31
- 8 remaining time of sleep timer
Sleep timer → p.31

2 Press **INFO** to hide the information.

Note

- While the program guide is displayed, the Closed Caption function is interrupted.
- The information display will automatically disappear in 5 seconds.

USB

Your TV is fitted with a USB connection that enables you to view photos, listen to music or watch video files stored on a USB Memory Stick.

- 1 Connect the USB Memory Stick to the USB terminal on the side of your TV.
- 2 Press **HOME** (MENU) and use **▲▼◀▶** to select **Browse USB**, then press **OK**.



- 3 Use **▲▼** to select the **Picture**, **Music** or **Video**, then press **OK**.
 - The files recorded under the following specifications are required.
 - Press **OPTION** to display the optional menu, then press **OK** to switch between **List** and **Thumbnails**.

| Picture (JPEG) | | | | |
|--------------------------|----------------------------|-------|---------------------|--------------|
| Upper limit | 16Mpixel | | | |
| Music (MP3) | | | | |
| Sampling frequency | 32 kHz, 44.1 kHz or 48 kHz | | | |
| Constant bit rate | 32 kbps - 320 kbps | | | |
| Video | | | | |
| Maximum size of a video | 1920 x 1080 | | | |
| Extension | .mpg, .mpeg | .vob | .avi | .mp4 |
| Video codec | MPEG1, MPEG2 | MPEG2 | MPEG4 SP, MPEG4 ASP | H.264, MPEG4 |
| Audio codec | | | | |
| Dolby Digital | YES | YES | YES | NO |
| MPEG1 audio layer3 (MP3) | YES | NO | YES | NO |
| MPEG1 audio layer2 | YES | NO | YES | NO |
| LPCM | YES | NO | NO | NO |
| AAC-LC | NO | NO | NO | YES |

Note

- Up to 2GB (FAT16) or 8GB (FAT32) capacity can be supported.
- Up to 10,000 files or 1,000 folders with 19 hierarchies can be recognized.
- Up to 255 English characters can be recognized.
- This unit does not support MTP(Media Transfer Protocol).
- This unit supports FAT16 and FAT32 file systems.
- If the file is not supported, an error message appears.
- When the USB Memory Stick is not recognized, try reconnecting it again.
- We cannot be held responsible if your USB Memory Stick is not supported, nor will we accept any liability for damage or loss of stored data.
- A file name exceeding 256 characters or contains a dot character is not supported on this TV.
- Progressive JPEG files are not supported.

Picture (JPEG)

- 1 Use **▲▼** to select a file or a folder.



- 2 Press **OK** or **▶||** to start a Slide show of the files.
 - Press **OK** or **▶||** to pause the Slide show.
 - The **||** icon appears.
 - Press **◀▶** or **▶▶** to move between images.
 - Press **BACK** or **■** to stop the Slide show.
 - Press **OPTION** to display the optional menu, then use **▲▼** to select the desired item.

| | | |
|---------------|---|--|
| Slide time*1 | Short | Switches to the next image in 5 seconds. |
| | Medium | Switches to the next image in 10 seconds. |
| | Long | Switches to the next image in 15 seconds. |
| Transitions*1 | None | No effect when switching images. |
| | Dissolve | Overlaps a next image on a current image. |
| | Wipe right | Pushes a current image out from left. |
| | Wipe left | Pushes a current image out from right. |
| | Wipe up | Pushes a current image out from bottom. |
| | Wipe down | Pushes a current image out from top. |
| | Box in | A next image comes into the center from out. |
| Box out | A next image goes to the out from center. | |
| Auto picture | Selects the picture mode according to your preference. (Standard, Vivid, Sports, Movie, Game, Energy saving and Internet video) | |
| Rotate*2 | 0 | Displays an image at its original direction. |
| | 90 | Rotates an image clockwise by 90 degrees. |
| | 180 | Rotates an image clockwise 180 degrees. |
| | 270 | Rotates an image clockwise 270 degrees. |
| Zoom*2 | 1X | Displays an image at its original size. |
| | 2X | Magnifies a current image by 2 times. |
| | 4X | Magnifies a current image by 4 times. |

*1 You can set **Slide time** and **Transitions** when images are in Slide show.

*2 You can set **Rotate** and **Zoom** when Slide show is in Pause mode.

Music (MP3)

1 Use ▲▼ to select a file or a folder.



2 Press **OK** or **▶||** to play the selected files.

- Press **OK** or **▶||** to pause, then press **OK** or **▶||** again to resume.
- Press **▶▶** to skip to the next file.
- Press **◀◀** to return to the beginning of the file currently playing.
- Press **■** to stop playback.
- Press **☰** **OPTIONS** to display the optional menu, then use ▲▼ to select the desired item.

| | | |
|-------------|---|---|
| Repeat | Off | Sets repeat playback to Off. |
| | On | Sets repeat playback for all MP3 files in the current folder. |
| Shuffle | Off | Sets shuffle playback to Off. |
| | On | Sets shuffle playback for all MP3 files in the current folder. |
| TV speakers | Off | The sound will not be output from the unit's speakers. |
| | On | The sound will be output from the unit's speakers. |
| | Speakers EasyLink | You can control Audio Output from your connected EasyLink Compliant Devices with VOL + / - by using this unit's remote control. |
| Auto sound | Selects the sound mode according to your preference. (Standard, Vivid, Sports, Movie, Music and News) | |

Note

- TV speakers will be displayed only when Master EasyLink is set to On. EasyLink (HDMI CEC) → p.36

Video

1 Use ▲▼ to select a file or a folder.



2 Press **OK** or **▶||** to play the selected files.

- Press **OK** or **▶||** to pause, then press **OK** or **▶||** again to resume.
- Press **▶▶** to fast-forward search.
- Press **◀◀** to fast-backward search.
- Press **■** to stop playback.

Press **▶||** to resume from the point at which playback was stopped. Press **OK** to play from the beginning of the file.

- Press **☰** **OPTIONS** to display the optional menu, then use ▲▼ to select the desired item.

| | | |
|--------------|---|---|
| TV speakers | Off | The sound will not be output from the unit's speakers. |
| | On | The sound will be output from the unit's speakers. |
| | Speakers EasyLink | You can control Audio Output from your connected EasyLink Compliant Devices with VOL + / - by using this unit's remote control. |
| Auto picture | Selects the picture mode according to your preference. (Standard, Vivid, Sports, Movie, Game, Energy saving and Internet video) | |
| Auto sound | Selects the sound mode according to your preference. (Standard, Vivid, Sports, Movie, Music and News) | |

Note

- The resume information will be kept even when the unit is Turned Off.
- If you play another file while the previously viewed file is being resumed, the resume information of the previously viewed file will be deleted.
- The file or the folder in resume stop mode will be highlighted in gray on List or Thumbnails.
- TV speakers will be displayed only when Master EasyLink is set to On. EasyLink (HDMI CEC) → p.36

5 Use more of your TV

This section describes the overview of the **Setup** menu displayed when you press **HOME** (MENU) and use **UP** **DOWN** **LEFT** **RIGHT** to select **Setup**. The **Setup** menu consists of the function setting items below.

- 1 Press **HOME** (MENU) to display the Home menu.



- 2 Use **UP** **DOWN** **LEFT** **RIGHT** to select **Setup**, then press **OK**.

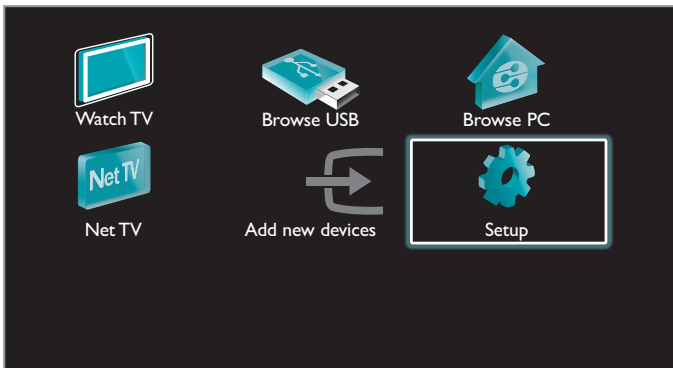

- 3 Use **UP** **DOWN** to select the desired menu and an item, then press **OK** or use **UP** **DOWN** **LEFT** **RIGHT** to determine the setting.

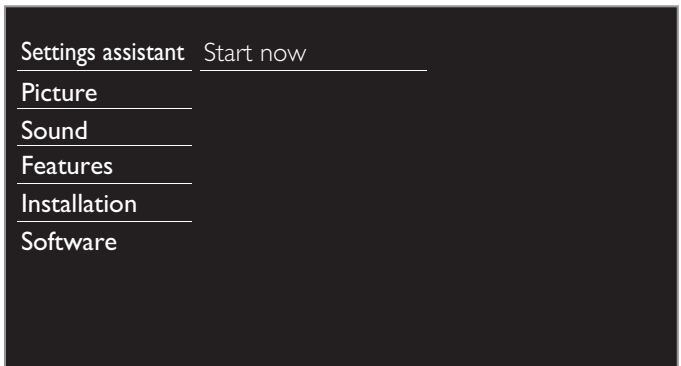

Settings assistant → p.27

Interactive wizard which guides you to get the best picture and sound settings.

Picture → p.27

Adjusting the Picture Mode or customize the Picture quality as your preference.

Sound → p.29

Adjusting the Sound Mode, Equalizer and some other Sound functions.

Features → p.30

Adjusting the Closed Caption, Parental Guide and some other useful functions.

Installation → p.33

You can choose language, scan the channels available in your area or make the Network settings.

Software → p.40

You can check the current software version, update the software or deactivate the setting for Netflix and VUDU.

- 4 When the Setting is completed, press **HOME** (MENU) or **BACK** to exit.

Settings assistant

Before you begin:

You must Set **Home** in **Location**. → p.35

Otherwise, personalized Picture and Sound settings will not be Memorized after the unit goes into Standby mode.

- 1 Press **HOME** (MENU) and use **▲▼◀▶** to select **Setup** then press **OK**.
- 2 Use **▲▼** to select **Settings assistant**, then press **OK**.

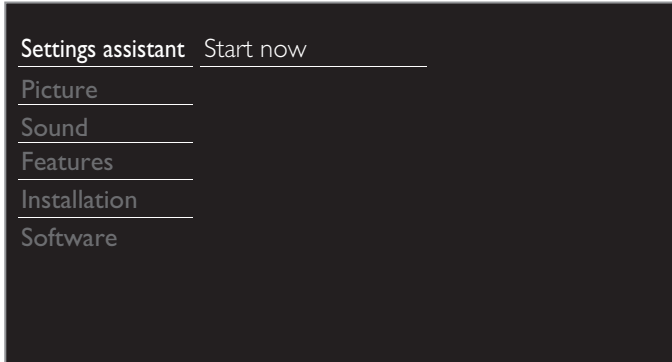

- 3 Press **OK** to begin **Settings assistant**.
- 4 Follow steps **8** to **11** in **Initial setup**. → p.18

Picture

Before you begin:

You must Set **Home** in **Location**. → p.35

Otherwise, personalized Picture and Sound settings will not be Memorized after the unit goes into Standby mode.

- 1 Press **HOME** (MENU) and use **▲▼◀▶** to select **Setup** then press **OK**.
- 2 Use **▲▼** to select **Picture**, then press **OK**.

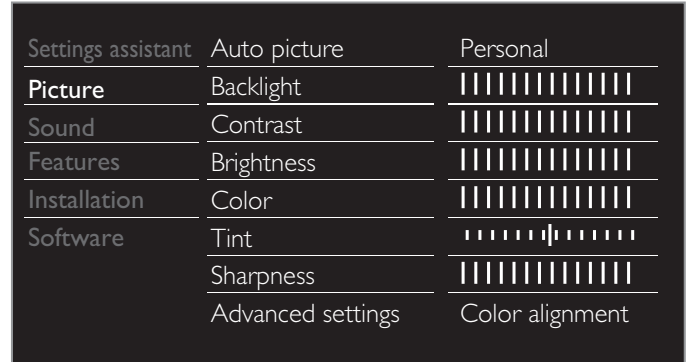

- 3 Use **▲▼◀▶** to select the item you want to adjust, then press **OK**.
 - The following picture settings can be configured. Depending on the format of the picture Source, some picture settings are not available.

| | | |
|-------------------|---|--------------------------------|
| Auto picture | to select the desired setting, then press OK (Personal , Standard , Vivid , Sports , Movie , Game and Energy saving and Internet video) When you adjust the following settings, Personal picture will be set automatically. | |
| | Cursor ◀ | Cursor ▶ |
| Backlight | to reduce power consumption | to set the backlight brighter |
| Contrast | to decrease contrast | to increase contrast |
| Brightness | to decrease brightness | to increase brightness |
| Color | to decrease color intensity | to increase color intensity |
| Tint | to add green | to add red |
| Sharpness | to soften | to sharpen |
| Advanced settings | to select the desired setting, then press OK (Color alignment , Noise reduction , Light sensor *1, Black stretch , Dynamic contrast , Gamma , Motion Rate , Dynamic backlight *2, MPEG artifact reduction , Color enhancement , Custom color management and Film mode) | |
| Picture format | Automatic Super zoom 4:3 Movie expand 14:9 Movie expand 16:9 Wide screen Unscaled | Changing picture format → p.23 |

Continued on next page.

| | | |
|---------------------|--|--|
| Mode selection | PC | to Turn Off image enhancement features which makes the TV to act purely as a monitor |
| | HDTV | to enable image enhancement features to improve picture quality |
| Auto adjustment | to adjust the horizontal / vertical position, clock and phase of the PC screen automatically | |
| | Cursor ◀ | Cursor ▶ |
| Clock | to decrease setting value | to increase setting value |
| Phase | | |
| Horizontal position | to move PC screen left | to move PC screen right |
| Vertical position | to move PC screen down | to move PC screen up |

You can set a particular about picture quality in Advanced settings.

| | | |
|-------------------|----------------------|---------|
| Auto picture | Color alignment | Mode |
| Backlight | Noise reduction | Auto |
| Contrast | Light sensor *1 | On |
| Brightness | Black stretch | Medium |
| Color | Dynamic contrast | Maximum |
| Tint | Gamma | |
| Sharpness | Motion Rate | Off |
| Advanced settings | Dynamic backlight *2 | Maximum |

| | | | |
|-----------------|--|---|-----------------------------------|
| Color alignment | Mode | to set the color temperature to Personal, Cool, Normal and Warm When you adjust the following settings, Personal will be set automatically. | |
| | | Cursor ◀ | Cursor ▶ |
| | Red gain | to decrease contrast with red | to increase contrast with red |
| | Green gain | to decrease contrast with green | to increase contrast with green |
| | Blue gain | to decrease contrast with blue | to increase contrast with blue |
| | Red offset | to decrease brightness with red | to increase brightness with red |
| | Green offset | to decrease brightness with green | to increase brightness with green |
| | Blue offset | to decrease brightness with blue | to increase brightness with blue |
| Noise reduction | to select the desired setting, then press OK (Off, Minimum, Medium, Maximum and Auto) | | |
| Light sensor *1 | Off | to set Light sensor to Off | |
| | On | to adjust backlight for the best picture quality by dynamically adjusting the backlight intensity in accordance with lighting condition in the room | |
| Black stretch | to select the desired setting, then press OK (Off, Minimum, Medium and Maximum) | | |

| | | | |
|-------------------------|--|---|--|
| Dynamic contrast | to select the desired setting, then press OK (Off, Minimum, Medium and Maximum) | | |
| Gamma | Cursor ◀ | Cursor ▶ | |
| | to adjust the gamma encoding of images | | |
| Motion Rate | Off | to set Motion Rate to Off | |
| | On | to make the video appear smooth | |
| Dynamic backlight *2 | to select the desired setting, then press OK (Off, Minimum, Medium and Maximum) | | |
| MPEG artifact reduction | to select the desired setting, then press OK (Off, Minimum, Medium and Maximum) | | |
| Color enhancement | Off | to set color enhancement to Off | |
| | On | to make colors more vivid and bright | |
| Custom color management | to select the desired setting, then press OK (Red, Yellow, Green, Cyan, Blue and Magenta) | | |
| | | Cursor ◀ | Cursor ▶ |
| | Tint | to rotate only selected color tint in clockwise direction | to rotate only selected color tint in counterclockwise direction |
| | Saturation | to decrease color with only selected color | to increase color with only selected color |
| | Brightness | to decrease brightness with only selected color | to increase brightness with only selected color |
| Film mode | Off | to set film mode to Off | |
| | Auto | to optimize the picture recorded by the original film | |

Note

- **Mode selection** is available only if
 - the external Input modes are selected HDMI 1, HDMI 2 or HDMI 3.
 - the connected HDMI device is outputting a video signal.
- Adjusts backlight for the best picture quality by dynamically adjusting the backlight intensity in accordance with lighting condition in the room when **Light sensor***1 is set to **On**. Please ensure the room lighting is stable and the light sensor is not blocked.

*1 50PFL3908 / 46PFL3908 / 46PFL3608 / 40PFL4908 / 39PFL2908 / 39PFL2608 only.

*2 50PFL3908 / 46PFL3908 / 46PFL3608 / 40PFL4908 only.

Sound

Before you begin:

You must set **Home** in **Location**. → p.35

Otherwise, personalized Picture and Sound settings will not be memorized after the unit goes into Standby mode.

- 1 Press **HOME** (MENU) and use **▲▼◀▶** to select **Setup** then press **OK**.
- 2 Use **▲▼** to select **Sound**, then press **OK**.

| | | |
|--------------------|------------------------|-----------|
| Settings assistant | Auto sound | Personal |
| Picture | Equalizer | Start now |
| Sound | Balance | |
| Features | Digital audio language | English |
| Installation | SRS TruSurround HD | On |
| Software | Auto volume leveling | Off |
| | TV speakers | On |
| | Headphone volume | |

- 3 Use **▲▼◀▶** to select the item you want to adjust, then press **OK**.

The following sound settings can be configured. Depending on the format of the broadcasting, some sound settings are not available.

| | |
|-------------------|---|
| Auto sound | to select the desired setting. (Personal, Standard, Vivid, Sports, Movie, Music and News) When you adjust the following settings (Equalizer, SRS TruSurround HD and Auto volume leveling), Personal sound will be set automatically. |
|-------------------|---|

Adjust the tonal quality for each frequency.

| | | |
|------------------|---|----------|
| Equalizer | Cursor ◀ | Cursor ▶ |
| | to adjust each level of tonal quality Press BACK to go back to the previous menu. | |

Adjust the speakers to suit your listening preference.

| | | |
|----------------|--|----------|
| Balance | Cursor ◀ | Cursor ▶ |
| | to adjust the balance of the right and left speakers | |

Digital TV operation

You can select the Audio language while your TV is receiving the Digital broadcasting.

| | |
|-------------------------------|---|
| Digital audio language | to select the language according to your preference. (It differs depending on the program.) |
|-------------------------------|---|

Analog/Cable TV operation

You can select **Main** or **SAP** while your TV is receiving the Analog broadcasting that has the SAP (Second Audio Program). (It differs depending on the program.)

| | | |
|------------------------|-------------|--------------------------------|
| Alternate audio | Main | to output main-audio |
| | SAP | to output second-audio program |

Analog/Cable TV operation

When you set to **Main** in **Alternate audio** above, you can select **Mono** or **Stereo** if the Analog broadcasting is sending the MTS (Multichannel television sound).

| | | |
|--------------------|---------------|------------------------|
| Mono/Stereo | Mono | to output mono-audio |
| | Stereo | to output stereo-audio |

This selects sound modes for more spatial or surround sound reproduction.

| | | |
|---------------------------|------------|-----------------------------------|
| SRS TruSurround HD | Off | to set SRS TruSurround HD™ to Off |
| | On | to set SRS TruSurround HD™ to On |

This function keeps a constant loudness differential between the TV commercials and the programs.

| | | |
|-----------------------------|------------|--|
| Auto volume leveling | Off | to remove the auto volume leveling |
| | On | to reduce volume differences between the TV commercials and the programs |

You can select the Audio Output from the unit's speakers or not. If your amplifier is HDMI link function compatible and connected by an HDMI cable to this unit, some sound operations such as volume up can be changed by using this unit's remote control. Make sure **Master EasyLink** is set to **On**. → p.36

| | | |
|--------------------|--------------------------|---|
| TV speakers | Off | not to output sound from the unit's speakers |
| | On | to output sound from the unit's speakers |
| | Speakers EasyLink | to control Audio Output from your connected EasyLink Compliant Devices with VOL + / - by using this unit's remote control. |

Adjust headphone volume.

| | | |
|-------------------------|--------------------------------|----------|
| Headphone volume | Cursor ◀ | Cursor ▶ |
| | to decrease or increase volume | |

You can set the digital audio output format from SPDIF/ARC.

| | | |
|------------------------------|---------------------|---|
| Digital output format | PCM | to output PCM signals. |
| | Multichannel | to output multichannel signals. (When the audio of the content is PCM, it will be output in PCM even if Multichannel is selected.) |

If a channel or Input device is too loud or too soft, navigate to that channel or Input device.

| | | |
|---------------------|---|---|
| Delta volume | Cursor ◀ | Cursor ▶ |
| | to set a negative delta volume level as per your personal preferences | to set a positive delta volume level as per your personal preferences |

Note

- **Alternate audio** and **Mono/Stereo** are not available when you watching TV programs with a cable box or satellite set-top box connected through an HDMI cable or Component / Composite Video cables.

Features

- 1 Press **⬆** (MENU) and use **▲▼◀▶** to select **Setup** then press **OK**.
- 2 Use **▲▼** to select **Features**, then press **OK**.

| | | |
|--------------------|------------------|-----------------|
| Settings assistant | Caption settings | Closed captions |
| Picture | Sleep timer | |
| Sound | Child lock | Channel lock |
| Features | Change PIN | Start now |
| Installation | | |
| Software | | |

- 3 Adjust the following items.

Caption settings

Closed Captioning displays the audio portion of programming as text superimposed over the video.

- 1 Use **▲▼** to select **Caption settings**, then press **OK**.

| | | |
|------------------|-------------------------|------------------|
| Caption settings | Closed captions | Off |
| Sleep timer | Caption service | CC-1 |
| Child lock | Digital caption service | CS-1 |
| Change PIN | Digital caption options | Reset to default |

| | | |
|----------------|---------------|--|
| Closed Caption | Off | not to display the Closed Caption |
| | On | to display the Closed Caption |
| | CC w/ mute | to display the Closed Caption when you set to mute |

Note

- You can cycle through the **Closed Caption** settings by pressing **CC**.

Digital TV operation

In addition to the basic Closed Caption, DTV has its own Closed Caption called Digital caption service. Use this menu to change the settings for Digital caption service.

| | | |
|-------------------------|--------------|---|
| Digital caption service | CS-1 to CS-6 | Selects one of these before changing any other item in Caption settings menu. Choose CS-1 under normal circumstances. |
|-------------------------|--------------|---|

You can choose the size, font, color, background and other characteristics of the caption text.

| | | |
|-------------------------|------------------|--|
| Digital caption options | Reset to default | You can reset the status of Digital caption options. |
| | | You can change Closed Captioning font style, size, color and transparency. (Font style , Font size , Font color and Font opacity) |
| | | You can change background color and transparency of the displayed caption. (Background color and Background opacity) |
| | | You can change edge color and type of the displayed caption. (Edge color and Edge type) |

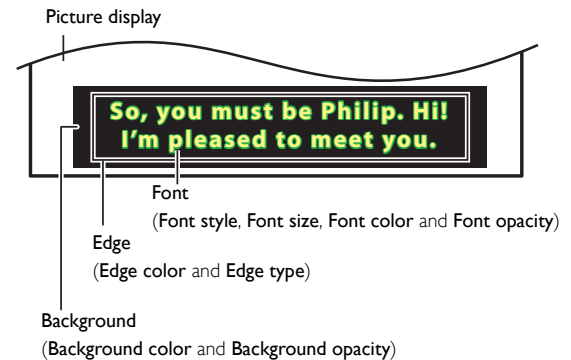

- Review your setting choice made below by looking in the upper left corner of the displayed setting box (not all selections show the differences selected).

Analog/Cable TV operation

| | | |
|-----------------|-------------------------|---|
| Caption service | CC-1 and T-1 | The primary caption and text services. The captioning or text is displayed in the same language as the program's dialog (up to 4 lines of script on the TV screen). |
| | CC-3 and T-3 | Serve as the preferred data channels. The captioning or text is often a secondary language. |
| | CC-2, CC-4, T-2 and T-4 | Rarely available and broadcasters use them only in special conditions, such as when CC-1 and CC-3 or T-1 and T-3 are not available. |

- There are 3 display modes according to programs:

| | |
|----------|---|
| Paint-on | Displays input characters on the TV screen immediately. |
| Pop-on | Once characters are stored in memory, they are displayed all at once. |
| Roll-up | Displays the characters continuously by scrolling (max. 4 lines). |

Continued on next page.

Note

- **Digital caption service** that you can switch differs depending on the broadcast description.
- Closed Captioning service may not be controlled by this unit's menu options if you are watching television through an external cable or satellite set-top box. In which case you will need to use the menu options on the external set-top box to control Closed Captioning.
- The captions do not always use correct spelling and grammar.
- Not all TV programs and product commercials include Closed Caption information. Refer to your area TV program listings for the TV channels and times of Closed Caption shows. The captioned programs are usually noted in the TV listings with service marks such as **CC**.
- Not all captioning services are used by a TV channel during the transmission of a Closed Caption program.
- Closed Caption will NOT be displayed when you are using an HDMI or a Component (except for 480i) connection.
- To show the Closed Caption on your TV screen, broadcast signal must contain the Closed Caption data.
- Not all TV programs and commercials have the Closed Caption or all types of the Closed Caption.
- Captions and texts may not exactly match the TV voice.
- Changing channels may delay the Closed Caption for a few seconds.
- Adjusting or muting the volume may delay the Closed Caption for a few seconds.
- Abbreviations, symbols and other grammatical shortcuts may be used in order to keep pace with the on-screen action. This is not a malfunction.
- The caption or text characters will not be displayed while the Home menu or functions display is shown.
- If a black box appears on the TV screen, this means that the Closed Caption is set to the text mode. To clear the box, select **CC-1**, **CC-2**, **CC-3** or **CC-4**.
- If the unit receives poor quality television signals, the captions may contain errors or there might be no captions at all. Some possible causes of poor quality signals are:
 - Automobile ignition noise
 - Electric motor noise
 - Weak signal reception
 - Multiplex signal reception (ghosts or screen flutter)
 - Data dropout and Pixelation (for DTV only)
- The unit retains the Closed Caption setting if the power fails.
- When the unit receives special effects playback signal (e.g. Search, Slow and Still) from a VCR's video Output channel (ch3 or ch4), the unit may not display the correct caption or text.
- The EUT setting that satisfies § 79.102 (e) is as follows:
Font: Mono-font
Character size: Large

Child and ratings lock

You can prevent your children from watching certain programs or certain channels by locking the TV controls and by using ratings.

- 1 Use **▲▼** to select **Child lock**, then press **OK**.

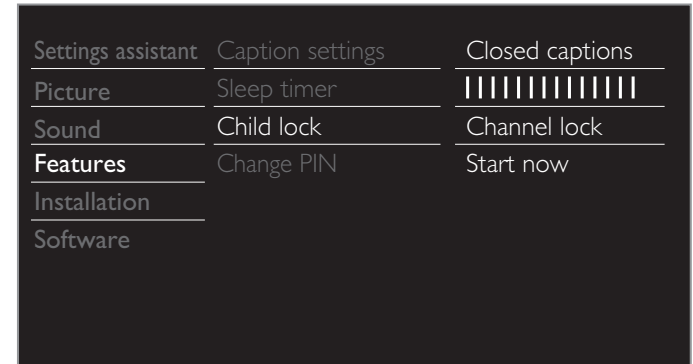

- 2 Use the **NUMBER** buttons to enter the 4-digit numbers for your PIN code.

- When you have not set up your PIN code, enter **0, 0, 0, 0**.
- When the PIN code is correct, **Child lock** menu is displayed.

See the following description for setting each item.

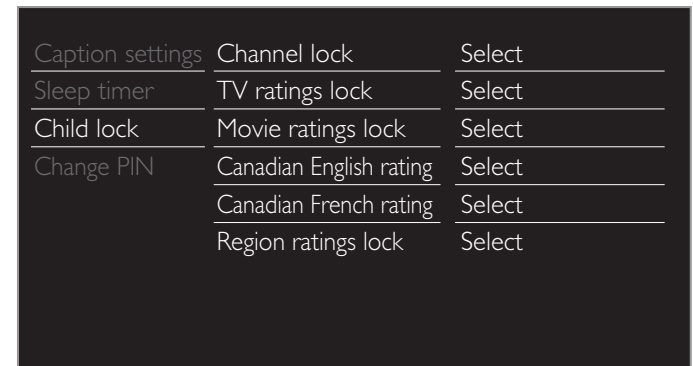

Note

- When you select the higher rating and set it to , the lower ratings will be blocked automatically.
- When you set the **All** to , all ratings return to automatically.
- **Region ratings lock** will be available when the unit receives a Digital broadcast using the new rating system.
- To block any inappropriate programs, set your limits in **TV ratings lock**, **Movie ratings lock** and **Region ratings lock**.
- For the United States, the unit may download the Region Ratings Lock Table, if required.
- The Canadian rating systems on this unit are based on CEA-766-A and CRTC policy.

Continued on next page.

Sleeptimer

Sleep timer can set the unit to go into Standby mode after an incremental period of time.

- 1 Use **▲▼** to select **Sleeptimer**, then press **OK**.
- 2 Use **▶** repeatedly to change the amount of time (increases the time by 5 minutes up to 180 minutes).
 - Each press of **◀** will decrease the time by 5 minutes.
 - Press **ⓘ** **INFO** once to call up the display for checking the remaining time.
 - To cancel the sleep timer, press **▶** repeatedly until "0" is displayed.

Channel lock

Particular channels or external Input modes can be invisible in this function.

- 3 Use ▲▼ to select **Channel lock**, then press **OK**.
- 4 Use ▲▼ to select the particular channels or external Input, then press **OK** repeatedly to switch between view and block.
 - indicates that the channel or Input Source is locked.
 - indicates that the channel or Input Source is not locked.

| | | | |
|------------------|-------------------------|--|-----|
| Caption settings | Channel lock | <input type="checkbox"/> 40.1 | DTV |
| Sleep timer | TV ratings lock | <input checked="" type="checkbox"/> 40.2 | DTV |
| Child lock | Movie ratings lock | <input checked="" type="checkbox"/> 40.3 | DTV |
| Change PIN | Canadian English rating | <input checked="" type="checkbox"/> 40.4 | DTV |
| | Canadian French rating | <input type="checkbox"/> HDMI 1 | |
| | Region ratings lock | <input type="checkbox"/> HDMI 2 | |
| | | <input type="checkbox"/> HDMI 3 | |
| | | <input type="checkbox"/> Video | |

Setting TV and movie ratings

Movie ratings lock is the rating system created by MPAA. TV ratings lock has controlled access to individual programs based on their age ratings and content rating.

- 3 Use ▲▼ to select **TV ratings lock** or **Movie ratings lock**, then press **OK**.
- 4 Use ▲▼ to select the desired rating, then press **OK** repeatedly to switch between view and block.
 - indicates that the rating is locked.
 - indicates that the sub rating is locked.
 - indicates that the rating is not locked.

TV ratings lock

| | |
|-------------------------|--|
| Channel lock | <input type="checkbox"/> All |
| TV ratings lock | <input checked="" type="checkbox"/> None |
| Movie ratings lock | <input type="checkbox"/> TV-Y |
| Canadian English rating | <input type="checkbox"/> TV-Y7 |
| Canadian French rating | <input type="checkbox"/> TV-G |
| Region ratings lock | <input type="checkbox"/> TV-PG |
| | <input type="checkbox"/> TV-14 |
| | <input type="checkbox"/> TV-MA |

Movie ratings lock

| | | |
|------------------|-------------------------|--|
| Caption settings | Channel lock | <input type="checkbox"/> All |
| Sleep timer | TV ratings lock | <input checked="" type="checkbox"/> NR |
| Child lock | Movie ratings lock | <input type="checkbox"/> G |
| Change PIN | Canadian English rating | <input type="checkbox"/> PG |
| | Canadian French rating | <input type="checkbox"/> PG-13 |
| | Region ratings lock | <input type="checkbox"/> R |
| | | <input type="checkbox"/> NC-17 |
| | | <input type="checkbox"/> X |

| US movie ratings | US TV ratings | Description |
|------------------|---------------|--|
| All | | All ratings locked including no rating |
| NR | None | No rating |
| - | TV-Y | Appropriate for all children |
| - | TV-Y7 | Appropriate for all children 7 and older |
| G | TV-G | General audience |
| PG | TV-PG | Parental guidance suggested |
| PG-13 | - | Unsuitable for children under 13 |
| - | TV-14 | Unsuitable for children under 14 |
| R | - | Restricted under 17 requires accompanying parent or adult guardian |
| NC-17 | - | No one under 17 admitted |
| X | TV-MA | Mature audience only |

To set the sub ratings

For TV ratings lock, you can further set the sub ratings to block specific elements of programming. To set the sub ratings, follow the step below.

Use ▲▼◀▶ to select the desired rating, then press **OK** repeatedly to switch between and .

| | | |
|-------------------------|---|--|
| Channel lock | <input type="checkbox"/> All | <input checked="" type="checkbox"/> Fantasy Violence |
| TV ratings lock | <input type="checkbox"/> None | |
| Movie ratings lock | <input type="checkbox"/> TV-Y | |
| Canadian English rating | <input checked="" type="checkbox"/> TV-Y7 | |
| Canadian French rating | <input type="checkbox"/> TV-G | |
| Region ratings lock | <input type="checkbox"/> TV-PG | |
| | <input type="checkbox"/> TV-14 | |
| | <input type="checkbox"/> TV-MA | |

| US TV ratings | Sub Rating |
|---------------|---------------------------------------|
| TV-Y7 | Fantasy Violence |
| TV-PG | Dialog Language Sex Violence |
| TV-14 | Language Sex Violence |
| TV-MA | Language Sex Violence |

Note

- Blocked sub rating will appear beside the main rating category in **TV ratings lock** menu.
- You cannot block a sub rating if the main rating is set to .
- Changing the category to or automatically changes all its sub ratings to the same (or).

Continued on next page.

Canadian English or Canadian French ratings

You can select the rating for Canadian English or Canadian French broadcasting.

- Use ▲▼ to select **Canadian English rating** or **Canadian French rating**, then press **OK**.
- Use ▲▼ to select the desired rating, then press **OK** repeatedly to switch between view and block.
 - ☑ indicates that the rating is locked.
 - ☐ indicates that the rating is not locked.

| Canadian English rating | Canadian French rating | Description |
|-------------------------|------------------------|------------------------------|
| All | | Locked all ratings |
| E | | Exempt program |
| C | – | For all children |
| C8+ | – | For children over 8 |
| G | | General audience |
| – | 8ans+ | Unsuitable for ages under 8 |
| PG | – | Parental guidance suggested |
| – | 13ans+ | Unsuitable for ages under 13 |
| 14+ | – | Unsuitable for ages under 14 |
| – | 16ans+ | Unsuitable for ages under 16 |
| 18+ | 18ans+ | Adult audience only |

Note

- The V-Chip can block non rated programs as per "CEA-608-E sec. L3". If the option to block **NR**, **None** or **E** programs is used in **Movie ratings lock**, **TV ratings lock**, **Canadian English rating** or **Canadian French rating** accordingly "unusual results may occur and the unit may not receive emergency bulletins or other types of programming": / Emergency Bulletins (Such as EAS messages, weather warnings and others) / Locally originated programming / News / Political / Public Service Announcements / Religious / Sports / Weather.

Change PIN

Although the default PIN code (0000) is supplied with the unit, you can set your own PIN code.

- Use ▲▼ to select **Change PIN**, then press **OK**.
- Press the **NUMBER** buttons to enter the new 4-digit PIN code.
 - Enter PIN code again to confirm.

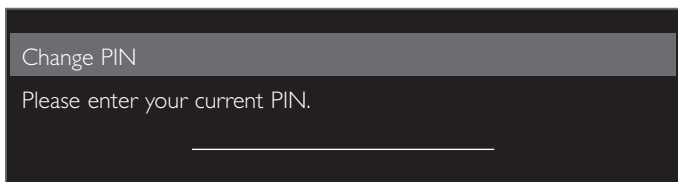

Note

- Make sure new PIN code and confirm PIN code must be exactly the same. If they are different, the space is cleared for reentering.
- If you have forgotten your PIN code, enter 0711 to reset the PIN code.

Installation

- Press **▲** (MENU) and use ▲▼◀▶ to select **Setup** then press **OK**.
- Use ▲▼ to select **Installation**, then press **OK**.

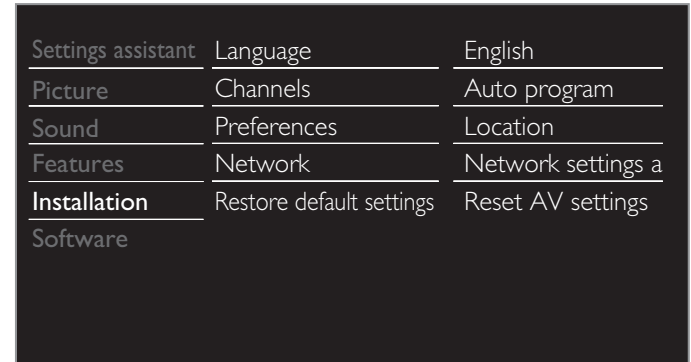

- Adjust the following items.

Language

- Use ▲▼ to select **Language**, then press **OK**.



- Use ▲▼ to select **English**, **Español** or **Français**, then press **OK**.

Note

- If you need the English menu instead of the Spanish or French menu's, press **▲** (MENU). Use ◀▶▲▼ to select **Configuración** or **Configuration**, then press **OK**. Use ▲▼ to select **Instalación** or **Installation**, then press **OK**. Use ▲▼ to select **Idioma** or **Langue**, then press **OK**. Use ▲▼ to select **English**, then press **OK**. Press **▲** (MENU) to exit the Home menu.

Channel installation

Be sure the RF cable is correctly connected to this unit and you are registered with your cable TV provider when you install cable channels.

Autoprogram

If you switch wires (e.g. between antenna and CATV) or if you move the unit to a different area after the initial setting, or if you restore the DTV channels you deleted, it is recommended to use AutoProgram to perform a new channel search.

You need to select the signal type in **Installation mode** before you perform AutoProgram.

- 1 Use ▲▼ to select **Channels**, then press **OK**.
- 2 Use ▲▼ to select **Autoprogram**, then press **OK**.
 - If you run **Autoprogram** when you have locked channels, a message appears asking to enter your PIN code. Enter your PIN code in order to complete the installation. You need to set the channel lock again after the installation.
- 3 Press **OK** to select **Start now**.
 - When the scanning and memorizing are completed, the lowest memorized channel will be displayed.
- 4 Follow the on-screen instructions to complete the installation.

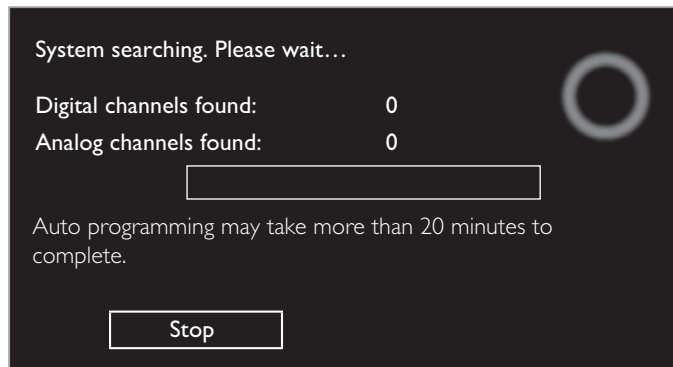

Note

- After setting **Autoprogram**, using **CH + / -** skips unavailable programs automatically.
- If you are not receiving a signal from your cable service, contact the cable provider.
- If you press **⏻** or during AutoProgram, the setup of TV channels will be canceled.
- Even if **Autoprogram** is completed, the channel setting will be lost if the AC power cord is unplugged before the unit goes into Standby mode by pressing **⏻**.
- The PIN code will be required once you set a PIN code in the **Child and ratings lock**. → p.31
- If you want to change your PIN code, follow the instruction of Change PIN. → p.33

Weak channel installation

This function lets you add the channels that were not added by the AutoProgram due to the reception conditions during the initial setup. It is available only when you select Antenna in **Installation mode**.

- 1 Use ▲▼ to select **Channels**, then press **OK**.
- 2 Use ▲▼ to select **Weak channel installation**, then press **OK**.
 - The PIN code will be required if you have locked channels.
- 3 Use ◀▶ to select channel Input box, then use ▲▼ to select a channel you want to memorize.
- 4 Use ◀▶ to select **Search**, then press **OK**.
- 5 Display will be changed to **Store** from **Search** when the channel is found, then press **OK**.

Note

- In most cases, Digital channels are not broadcast on the RF channel on which they appear on your TV. To add Digital channels you need to know the RF channel on which the Digital channel is being broadcast. (e.g. If there is a Digital channel 9.1 which is being broadcast on RF channel 25, you need to enter 25 while performing a weak channel installation.) To find out the RF channel on which a particular Digital channel is being broadcast, please contact your local service provider. Installing Digital channels using **Weak channel installation** might not work for direct cable connections and if the Digital signal is too weak for the TV to process.

Installation mode

- 1 Use ▲▼ to select **Channels**, then press **OK**.
- 2 Use ▲▼ to select **Installation mode**, then press **OK**.
- 3 Use ◀▶ to select **Antenna** or **Cable**, then press **OK**.
 - When **Antenna** is selected, the TV detects antenna signals. It searches for DTV and Analog TV channels available in your area.
 - When **Cable** is selected, the TV detects signals supplied by cable. It searches for DTV Analog TV and Cable channels available in your area.

Uninstall channels

The channels selected here can be skipped when selecting the channels using **CH + / -**.

Those channels can still be selected with the **NUMBER** buttons.

- 1 Use ▲▼ to select **Channels**, then press **OK**.
- 2 Use ▲▼ to select **Uninstall channels**, then press **OK**.
- 3 Use ▲▼ to select the channel you want to remove, then press **OK**.
 - The removed channels are not displayed on the list of favorite channels.
 - To reactivate a removed channel, use ▲▼ then press **OK**.

Preferences

You can set the unit to reduce the power consumption or adjust the backlight brightness in **Location** setting.

In **TV placement** setting, you can set the unit placement in order to obtain the best sound effect.

EasyLink allows you to operate your connected EasyLink device.

Setting your location to home

Choosing **Home** gives you full flexibility to change predefined settings for picture and sound.

- 1 Use ▲▼ to select **Preferences**, then press **OK**.
- 2 Use ▲▼ to select **Location**, then press **OK**.



- 3 Use ▲▼ to select **Home**, then press **OK**.

| | |
|---------------|---|
| Retail | The unit will be set up with predefined settings for retail displays. In this setting, the power consumption may possibly exceed the limit requirement of the ENERGY STAR® qualification. |
| Home | This setting is ENERGY STAR® qualified. The unit is set to maximize the energy efficiency for home setting and it can be adjusted through a choice of picture and sound quality according to your preference. |

Note

- You must set **Home**. Otherwise, personalized picture and sound settings will not be memorized after the unit goes into Standby mode.
- If you select **Home**, E-sticker will not be displayed.

TV placement

To apply the best settings for your TV, select wall mount or stand mount.

- 1 Use ▲▼ to select **Preferences**, then press **OK**.
- 2 Use ▲▼ to select **TV placement**, then press **OK**.
- 3 Use ▲▼ to select **Wall mounted** or **On a TV stand**, then press **OK**.

E-sticker

When you set **Location** to **Retail**, E-sticker (Electronic Sticker) is displayed. E-sticker can be Turned Off using procedure below.

- 1 Use ▲▼ to select **Preferences**, then press **OK**.
- 2 Use ▲▼ to select **E-sticker**, then press **OK**.
- 3 Use ▲▼ to select **Off**, then press **OK**.

Use Philips EasyLink

Your TV supports Philips EasyLink, which enables one-touch play and one-touch Standby between EasyLink-compliant devices. Compliant devices must be connected via an HDMI connector.

One-touch play

When you connect your TV to devices that support one-touch play, you can control your TV and the devices with one remote control. For example, when you press ► (**play**) on your DVD remote control, your TV automatically switches to the correct channel to show the DVD content.

One-touch Standby

When you connect your TV to devices that support Standby, you can use your TV remote control to put your TV and all connected HDMI devices in Standby mode. You can perform one-touch Standby using the remote control from any of the connected HDMI devices.

System audio control

When you connect your TV to HDMI CEC compliant devices, your TV can switch automatically to play audio from the connected device. To use one-touch audio, you must map the audio input from the connected device to your TV. You can use the remote control from the connected device to adjust the volume.

Remote control (RC) key forwarding

RC key forwarding allows you to control EasyLink-compliant devices using your TV remote control.

HDMI-ARC (Audio Return Channel) (HDMI 1 only)

HDMI-ARC allows you to use Philips EasyLink to output TV audio directly to a connected Audio device, without the need for an additional Digital Audio cable. Be sure that the device is HDMI CEC and ARC compliant, and that the TV is connected to the device using an HDMI cable attached to both HDMI-ARC connectors.

Note

- Philips does not guarantee 100% interoperability with all HDMI CEC devices.
- The EasyLink-compliant device must be Switched On and selected as the source.

EasyLink (HDMI CEC)

This function allows you to operate the linked functions between our brand devices with a EasyLink feature and this unit connecting through an HDMI cable. You must connect this unit to our brand EasyLink devices and be sure its EasyLink setting is also set to On.

- 1 Use ▲▼ to select **Preferences**, then press **OK**.
- 2 Use ▲▼ to select **EasyLink**, then press **OK**.
- 3 Use ▲▼◀▶ to select the item you want to adjust, then press **OK**.

| | | |
|--------------|-------------------|--------|
| Location | Master EasyLink | On |
| EasyLink | Auto TV On | On |
| TV placement | RC Key forwarding | Select |
| | HDMI-ARC | Off |
| | Device List | Select |

Set the **Master EasyLink** to **On** or **Off**. The following additional settings will be grayed out when you set to **Off**.

| | | |
|------------------------|------------|---|
| Master EasyLink | Off | Disables all EasyLink. |
| | On | Selects if you have connected an external device that is compatible with the EasyLink function. |

This unit will Turn On when the Power On signal is sent from your connected EasyLink device.

| | | |
|-------------------|------------|---|
| Auto TV on | Off | This unit stays in Standby mode even if you Turn On your connected EasyLink device. |
| | On | This unit Turns on automatically when you Turn On your connected EasyLink device. |

You can operate some functions such as disc playback or call up the menu of the connected devices, by using this unit's remote control. You can set each HDMI input to activate the **RC key forwarding**. Each press of **OK** will toggle RC key forwarding **On** or **Off**.

- indicates that the **RC key forwarding** is **On**.
- indicates that the **RC key forwarding** is **Off**

| | | |
|--------------------------|--------------|---|
| RC key forwarding | HDMI1 | PLAY, PAUSE ▶ / STOP ■ / FWD ▶▶ / REV ◀◀ /  OPTIONS / ▲▼◀▶ / OK / BACK / the NUMBER buttons can be used to control your connected EasyLink devices by this unit's remote control. |
| | HDMI2 | |
| | HDMI3 | |

HDMI-ARC allows you to use Philips EasyLink to output TV Audio directly to a connected Audio device, without the need for an additional Digital Audio cable

| | | |
|-----------------------------------|------------|--|
| HDMI-ARC (HDMI 1 only) | Off | Disable HDMI-ARC. |
| | On | You can output TV Audio through the HDMI cable solely, provided both the TV and device are HDMI-ARC compliant. |

Device list

This function lets you see the product model number or name of connected devices.

Use ▲▼ to select the desired EasyLink devices listed on the TV screen, then press **OK**.

Your connected EasyLink device will be Turned On if the device is in Stand by mode.

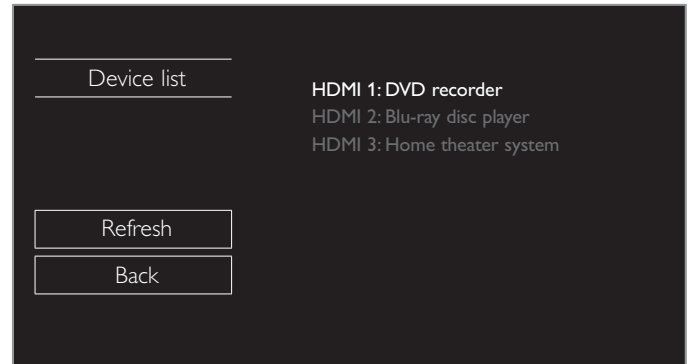

Network

Set up network connection settings in order to use Net TV or network upgrade function.

- The meanings of abbreviations are defined as below.
 - AP: Wireless LAN Access Point
 - WPS: Wi-Fi protected Setup
 - SSID: Wireless network name
- The key entry screen will appear when you select SSID, WEP / WPA / WPA2 or Proxy address.



- Enter the key of the selected wireless network using ▲▼◀▶, then press **OK**.
 - Clear:** Clear the entered number or word.
 - All clear:** Clear all the entered numbers or words.
 - a/A/@:** Switch between abc, ABC and @!?
 - Cancel:** Shows the cancellation display.
 - OK:** Set the entered number or word.

1 Use ▲▼ to select **Network**, then press **OK**.

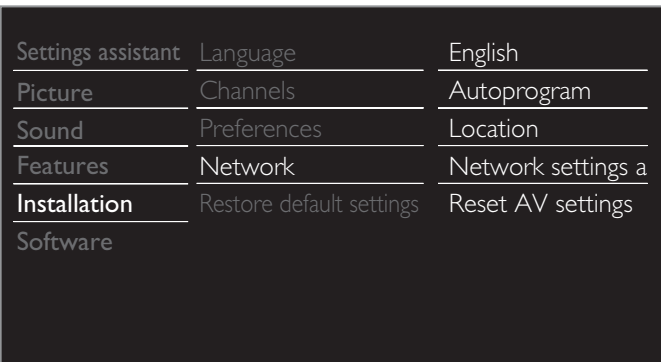

Network settings assistant

Before you proceed to **Connection test** or other settings in **Network** section, run the **Network settings assistant** to connect the TV to your network.

2 Use ▲▼ to select **Network settings assistant**, then press **OK**.

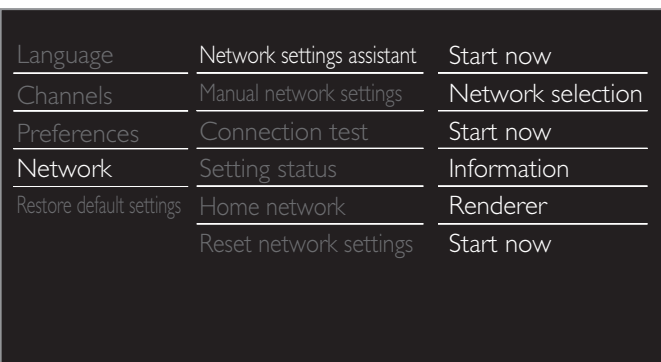

3 Press **OK** to select **Start now**.

Wireless setting

Select to use a wireless LAN to connect to the Internet by wireless connection.

4 Use ▲▼ to select **Wireless**, then press **OK**.

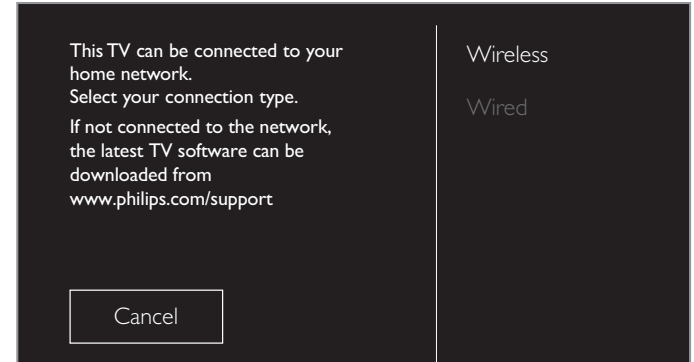

5 Use ▲▼ to select the desired setting, then press **OK**, and follow the on-screen directions.

| | |
|---------------------|---|
| Easy connect | Select this setting if your router has a WPS button. Start scanning for wireless networks on the TV after pressing the WPS button on your router. If connection test fails, try Easy connect again.*1 If it fails then refer to the router's manual for more details. |
| Scan | Search for wireless networks automatically and select the SSID from the list. Wireless network setting → p.38 |
| Manual | Set up the connection to the AP (e.g. wireless router) manually by entering the SSID. |

*1 WPS (Easy Connect) cannot be used when the security protocol is set to WEP. Change the Access Point's security mode from WEP to WPA or WPA2 (recommended).

Wired setting

Select to use an Ethernet cable to connect to the Internet by wired connection. Please purchase shielded Ethernet cables at your local store and use it when you connect to network equipment.

4 Use ▲▼ to select **Wired**, then press **OK**.

- Connection test** will start automatically. → p.39

Manual network settings

2 Use ▲▼ to select **Manual network settings**, then press **OK**.

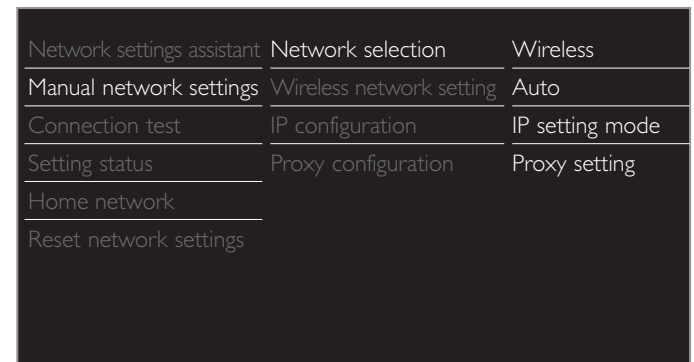

Network selection

3 Use ▲▼ to select **Network selection**, then press **OK**.

4 Use ▲▼ to select the desired setting, then press **OK**.

| | |
|-----------------|--|
| Wired | If you connect to an Ethernet cable, select Wired to connect to the Internet. |
| Wireless | If you have a router with WPS function, select Wireless to connect to the Internet. |

Continued on next page.

Wireless network setting

This menu is displayed only when you set **Wireless** in **Network selection**. In order to use a wireless network, you must set up a connection to the AP (e.g. wireless router).

3 Use ▲▼ to select **Wireless network setting**, then press **OK**.

Auto

Search for wireless networks automatically and select the SSID from the list.

4 Use ▲▼ to select **Auto**, then press **OK**.

5 The list of wireless networks will be displayed.

Use ▲▼ to select the appropriate the SSID, then press **OK**.

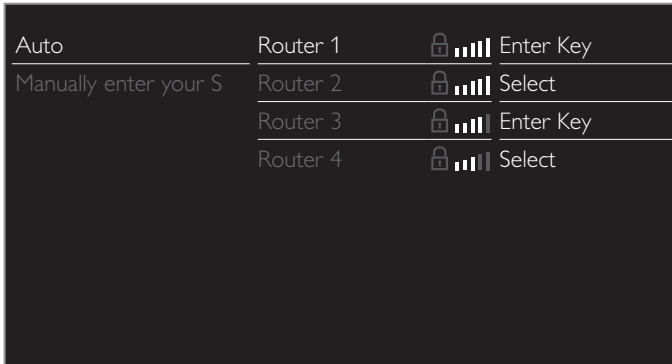

- If you select the SSID with , WEP*2 / WPA / WPA2 Key entry screen will appear.
Enter the WEP*2 / WPA / WPA2 key of the selected wireless network using ▲▼◀▶, then press **OK**.
- If you select the SSID has a WPS, the WPS setting screen will appear.
Use ▲▼◀▶ to select a setting, then press **OK**.

| | |
|---------------------|--|
| Easy connect | Select this setting if your router has a WPS button. Start scanning for wireless networks on the TV after pressing the WPS button on your router. If connection test fails, try Easy connect again.*1 If it fails then refer to the router's manual for more details. |
| WPS code | Select this setting if your router has a WPS but does not have a WPS button. Enter the 8-digit WPS PIN code shown on your TV in the router settings menu via PC before Connect is selected. |
| Manual | If your wireless network with authentication setting (WEP*2, WPA-PSK or WPA2-PSK), WEP*2 / WPA / WPA2 Key entry screen will appear. Enter the WEP*2 / WPA / WPA2 key of the selected wireless network using ▲▼◀▶, then press OK . |

*1 WPS (Easy Connect) cannot be used when the security protocol is set to WEP. Change the Access Point's security mode from WEP to WPA or WPA2 (recommended).

*2 WEP is not recommended to be used due to its Major security flaws. Change the Security protocol on the wireless router to WPA or WPA2 (recommended) mode.

Confirmation message will appear. Select **OK** to complete the settings.

Note

- For a wireless network with authentication setting, key icon appears to the right hand of the SSID.
- Signal icon shows the strength of the signal.
- WEP*2 / WPA key appears as asterisks on the confirmation screen.
- The wireless LAN supports following specifications.
 - Wireless standards: IEEE 802.11 b/g/n
 - Frequency spectrum: 2.4GHz
 - Security protocol: WEP*2 / WPA / WPA2

Manually enter your SSID

Set up the connection to the AP (e.g. wireless router) manually by entering the SSID.

4 Use ▲▼ to select **Manually enter your SSID**, then press **OK**.
• AP (e.g. wireless router) SSID entry screen will appear.
Enter the SSID using ▲▼◀▶, then press **OK**.

5 Use ▲▼ to select the authentication setting of the selected wireless network.
• For a wireless network with authentication setting, select the authentication setting, according to the security type of the wireless network.

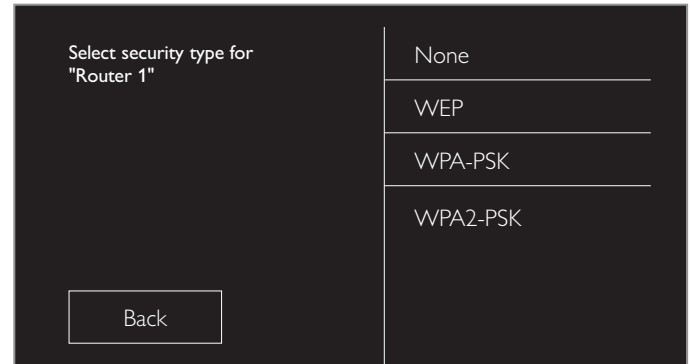

| | |
|-----------------|---|
| None | Set the authentication setting to None . |
| WEP | Set the authentication setting to WEP*2 . |
| WPA-PSK | Set the authentication setting to WPA-PSK |
| WPA2-PSK | Set the authentication setting to WPA2-PSK . |

- For a wireless network without authentication setting, select **None**.
- If you select **WEP*2**, **WPA-PSK** or **WPA2-PSK**, WEP*2 / WPA / WPA2 Key entry screen will appear.
Enter the WEP*2 / WPA / WPA2 key of the selected wireless network using ▲▼◀▶, then press **OK**.
- Confirmation message will appear. Select **Yes** to complete the settings.

*2 WEP is not recommended to be used due to its Major security flaws. Change the Security protocol on the wireless router to WPA or WPA2 (recommended) mode.

Continued on next page.

IP configuration

In following cases, select **IP configuration** to set each setting as necessary.

- When connection test failed with the setting of **Connection test**.
- When instructed by your Internet service provider to make specific settings in accordance with your network environment.

3 Use ▲▼ to select **IP configuration**, then press **OK**.

4 Use ▲▼ to select a setting, then press **OK**.

| | | |
|--------------------------|-----------------|-------------------|
| Network selection | IP setting mode | Manual |
| Wireless network setting | IP address | 192.168.11.3 |
| IP configuration | Subnet mask | 255.255.255.0 |
| Proxy configuration | Default gateway | 192.168.11.1 |
| | Primary DNS | 192.168.11.1 |
| | Secondary DNS | 0.0.0.0 |
| | MAC address | 00:12:0E:10:09:15 |

| | | |
|----------------------------------|--|-------------------------------------|
| IP setting mode | Auto | Sets the IP setting automatically. |
| | Manual | Sets the IP setting manually. |
| IP address* ^{1, 3} | A set of numbers which are assigned to devices participating in a computer network. | |
| Subnet mask* ^{1, 3} | A mask which is used to determine what subnet an IP address belongs to. | |
| Default gateway* ^{1, 3} | IP address of the network device (such as router) which provides Internet access. | |
| DNS setting mode | Auto | Sets the DNS setting automatically. |
| | Manual | Sets the DNS setting manually. |
| Primary DNS* ^{2, 3} | A server which handles the name and IP address over the Internet. | |
| Secondary DNS* ^{2, 3} | A server which handles the name and IP address over the Internet. | |
| MAC address | An address which recognizes the devices connecting to the network. It is also called Hardware Address. | |

*¹Items can be selected only when **IP setting mode** is set to **Manual**.

*²Items can be selected only when **DNS setting mode** is set to **Manual**.

*³Use ▲▼ or the **NUMBER** buttons to input numbers. When you use ▲▼ to input numbers, then press **OK** or input the triple digits by using the **NUMBER** buttons, the cursor moves to the next entry field. When you use ▲▼ to input numbers, then press **OK** or input the triple digits by using the **NUMBER** buttons at the rightmost entry field, numbers will be stored and go back to the previous menu.

Note

- The range of input numbers is between 0 and 255.
- If you enter a number larger than 255, the number will automatically be 255.
- The manually entered number will be saved even if you change the setting to **Auto**.
- If you want to enter 1 or 2 digit number in one cell, press **OK** to move on to the next cell.
- If the entered IP address or the default gateway or primary DNS number is same as the default setting, IP address setting will be set to **Auto**. (The manually entered number will be saved).
- When IP address setting is set to **Manual**, the setting of DNS setting will automatically be **Manual** and when IP address setting is set to **Auto**, you can set either **Auto** or **Manual** for DNS setting.

Proxy configuration

3 Use ▲▼ to select **Proxy configuration**, then press **OK**.

4 Use ▲▼ to select a setting, then press **OK**.

| | | |
|--------------------------|---------------|------------|
| Network selection | Proxy setting | Do not use |
| Wireless network setting | | |
| IP configuration | | |
| Proxy configuration | | |

- **Do not use** is selected for default settings.
- If you need to change the proxy setting as instructed by your Internet service provider to set the designated proxy address and port, select **Use**.

| | | |
|----------------|--|---------------------------|
| Proxy setting | Do not use | Not use the proxy server. |
| | Use | Uses the proxy server. |
| Proxy address* | Selects the number or word by using ▲▼◀▶, then press OK . | |
| Proxy port* | Use ▲▼ or the NUMBER buttons to input numbers. | |

* Items can be selected only when **Proxy setting** is set to **Use**.

Note

- The range of input numbers for the port number is between 0 and 65535. (If you enter a number larger than 65535, it will be regarded as 65535.)
- For proxy port, the selected ports may be blocked and not be able to use depending on your network environment.
- If the proxy address is entered with blank only, proxy server setting will be set to **Do not use**.

Connection test

Perform the following steps to test your Internet connection after you have connected an Ethernet cable or entered network settings such as IP address, DNS settings, etc. manually.

2 Use ▲▼ to select **Connection test**, then press **OK**.

3 Press **OK** to select **Start now**.

- Connection test will start automatically and the test result for Home Network and Internet will appear right after the connection test finishes.
- "Testing..." is displayed while the connection test is in progress.

| Home network | Internet | Description |
|--------------|----------|---|
| Pass | Pass | Connection test is successfully completed. |
| Fail | - | Connection test for Home Network failed. Check the connection settings. |
| Pass | Fail | Connection test for Internet failed. Check the connection settings. |

- If the connection test for Internet passes, speed test will start automatically.

4 Press **OK** to go to the list of network status confirmation screen.

Note

- If the connection test for both Home Network and Internet pass, you are ready to use Net TV or network upgrade function using the internet without making any additional settings.
- If the connection test fails, check if the Ethernet cable is connected to this TV properly or if you have entered all the required details for the wireless LAN connection properly.

Setting status

You can check the status of network settings.

- Use ▲▼ to select **Setting status**, then press **OK**.
 - Network setting list will be displayed.
 - MAC address of this unit will be displayed in the list.

Home network

You can turn your TV into Digital Media Renderer (DMR), which can play video, music and photo files stored on DLNA certified home media servers connected to your home network by using Digital Media Controllers (DMC).

- Use ▲▼ to select **Home network**, then press **OK**.
- Use ▲▼◀▶ to select the item you want to adjust, then press **OK**.

| | | |
|---------------|--------------------------------|--|
| Renderer | On | Enable this unit to play files by using DMC. |
| | Off | Disable DMR. |
| Renderer name | Change the display name on DMC | |

Reset network settings

You can reset the status of network settings.

- Use ▲▼ to select **Reset network settings**, then press **OK**.
- Press **OK** to select **Start now**.

Return your settings to default values

You can return settings to their default values.

- Use ▲▼ to select **Restore default settings**, then press **OK**.
- Use ▲▼ to select **Reset AV settings** or **Reset all settings**, then press **OK**.

| | |
|--------------------|--|
| Reset AV settings | Return picture and sound settings to their default values. The channel installation settings are not affected. |
| Reset all settings | Return all the settings to their default values. |

- Press **OK** to select **Start now**.

Software

Philips continuously tries to improve its products and we strongly recommend that you upgrade the TV software when upgrades are available.

New software can be downloaded from our website at www.philips.com/support using the model number of your TV to find information.

- Press **⏠** (MENU) and use ▲▼◀▶ to select **Setup** then press **OK**.
- Use ▲▼ to select **Software**, then press **OK**.

| | | |
|--------------------|-------------------------|--------|
| Settings assistant | Software information | Select |
| Picture | Software update | USB |
| Sound | Automatically check for | Off |
| Features | Netflix deactivation | |
| Installation | Netflix ESN | |
| Software | VUDU deactivation | |
| | YouTube deactivation | |
| | Hulu Plus deactivation | |

Note

- Digital Rights Management**
This product contains technology subject to certain intellectual property rights of Microsoft. Use or distribution of this technology outside of this product is prohibited without the appropriate license(s) from Microsoft.

Checking your current software version

- Use ▲▼ to select **Software information**, then press **OK**.
 - The version and a description of the current software is displayed.

| | | |
|--------------------|-------------------------|------------------|
| Settings assistant | Software information | PHL-XXXXX_XXXX_X |
| Picture | Software update | |
| Sound | Automatically check for | |
| Features | Netflix deactivation | |
| Installation | Netflix ESN | |
| Software | VUDU deactivation | |
| | YouTube deactivation | |
| | Hulu Plus deactivation | |

Preparing for the software upgrade

You require the following equipment:

- A PC with web browsing capability
- An archive utility that supports the ZIP-format (e.g. WinZip for Windows or StuffIt for Mac OS)
- An empty clean formatted USB Memory Stick

Note

- Only FAT / DOS-formatted portable memory is supported.
- Use only software upgrades that can be found on the Philips web site.

Warning

- When the software upgrade is running, don't press any buttons.
- Do not remove the USB Memory Stick during the software upgrade.
- If an error occurs during the upgrade, retry the procedure or for further assistance, please contact Call Center.

Downloading the software

Find information and software related to your TV and download the latest software upgrade file to your PC.

- On your PC, open a web browser and go to www.philips.com/support.
- Enter the model number in the "Type the Model Number.." field.
- Click the desired software to be downloaded.
 - Decompress the ZIP-file.
- Copy the upgrade file to the root directory of the USB Memory Stick.

Upgrading the software

USB upgrade

You can upgrade the software by using USB Memory Stick.

- 1 Connect your USB Memory Stick with the upgrade file to the USB terminal on the side of your TV.

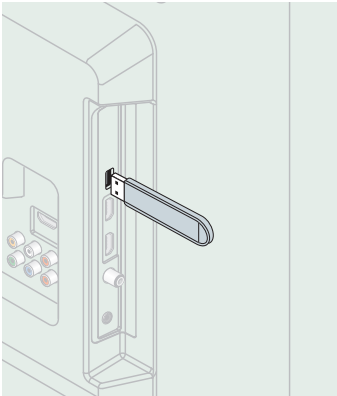

- 2 Use ▲▼ to select **Software update**, then press **OK**.
- 3 Use ▲▼ to select **USB**, then press **OK**.
- 4 Use ▲▼ to select the desired Update file.
- 5 Use ◀▶ to select **Yes**, then press **OK**.
- 6 Read the on-screen instructions and confirm that you want to continue with the installation.



- 7 When the software upgrade is completed, press ⏻ to set the unit into Standby mode, then remove the USB Memory Stick.
- 8 Unplug the AC power cord for a few seconds from AC outlet and plug it again.
- 9 Press ⏻ again to Turn the unit On.
 - The TV starts up with the new software.
 For further assistance, please contact Call Center.

Network update

You can update the software by connecting the unit to the Internet.

- 1 Use ▲▼ to select **Software update**, then press **OK**.
- 2 Use ▲▼ to select **Network**, then press **OK**.
- 3 Use ◀▶ to select **Yes**, then press **OK**.
 - This unit will then start checking for the latest firmware version.
- 4 Confirmation message will appear.
 - Use ◀▶ to select **Yes**, then press **OK**.
 - The unit will start downloading the latest firmware version.
 - The unit will start updating the firmware version.
 - It may take a while to complete the updating.

- 5 When the software update is complete, press ⏻ to make sure the unit goes to Standby mode.
- 6 Unplug the AC power cord for a few seconds from AC outlet and plug it again.
- 7 Press ⏻ again to Turn the unit On.
 - The TV starts up with the new software.
 For further assistance, please contact Call Center.

Note

- In order to update software via the Internet, you must connect the unit to the Internet and set up necessary settings. **Network settings assistant** → p.37 **Network** → p.37
- Please do not unplug the AC power cord or Ethernet cable while executing the **Network update**.
- All settings will remain the same even if you update the software version.
- The version of Net service will also be updated if newer version of Net service is available when updating the firmware.

Recovery update

If the unit turns off during the software upgrade, an error message will be displayed when you turn it on next time. In this case, please follow the procedure below to start the software upgrade again. The unit will not work correctly unless the software upgrade is completed.

- 1 Follow steps 1 to 2 in **Downloading the software** → p.40
- 2 Click the software for recovery update to be downloaded.
 - Decompress the ZIP-file.
- 3 Copy the recovery update file to the root directory of the USB Memory Stick
- 4 Connect the USB Memory Stick with the recovery update file to the USB terminal on the side of your TV, then press **OK**.
- 5 When the software update is complete, remove the USB Memory Stick.
- 6 Unplug the AC power cord for a few seconds from AC outlet and plug it again.
 - The TV starts up with the new software.
 For further assistance, please contact Call Center.

Automatically check for latest software

This function lets you know if the latest software is available while the unit is connected to the Internet.

- 1 Use ▲▼ to select **Automatically check for latest software**, then press **OK**.
- 2 Use ▲▼ to select the desired option, then press **OK**.

| | |
|-----|--|
| Off | Disable automatically check for latest software. |
| On | A message will appear if there is the latest software on the network server. |

Netflix deactivation

Displays the deactivation setting for Netflix.

- 1 Use ▲▼ to select **Netflix deactivation**, then press **OK**.
- 2 Use ▲▼ to select the desired option, then press **OK**.

| | |
|-----|---------------------------------------|
| Off | Deactivate the connection to Netflix. |
| On | Activate the connection to Netflix. |

Netflix ESN

Displays the ESN information.

- 1 Use ▲▼ to select **Netflix ESN**, then press **OK**.
 - Displays the ESN (Electronic Serial Number) to get any services from Netflix.

VUDU deactivation

Displays the deactivation setting for VUDU.

- 1 Use ▲▼ to select **VUDU deactivation**, then press **OK**.
- 2 Use ▲▼ to select the desired option, then press **OK**.

| | |
|-----|------------------------------------|
| Yes | Deactivate the connection to VUDU. |
| No | Activate the connection to VUDU. |

YouTube deactivation

Displays the deactivation setting for YouTube.

- 1 Use ▲▼ to select **YouTube deactivation**, then press **OK**.
- 2 Use ▲▼ to select the desired option, then press **OK**.

| | |
|-----|---------------------------------------|
| Yes | Deactivate the connection to YouTube. |
| No | Activate the connection to YouTube. |

Hulu Plus deactivation

Displays the deactivation setting for Hulu Plus.

- 1 Use ▲▼ to select **Hulu Plus deactivation**, then press **OK**.
- 2 Use ▲▼ to select the desired option, then press **OK**.

| | |
|-----|---|
| Yes | Deactivate the connection to Hulu Plus. |
| No | Activate the connection to Hulu Plus. |

License

Displays the Licenses of Open Source Software used in this unit.

- 1 Use ▲▼ to select **License**, then press **OK**.
 - Licenses of Open Source Software used in this unit are displayed.

Philips Wirelessconnect

You can enjoy your TV as a PC monitor wirelessly using your home network. Make sure you download the Philips Wirelessconnect software and install it on your PC before you perform the steps below.

Install Philips Wirelessconnect

- 1 Display **Setup** using Home menu and use ▲▼ to select **Software**, then press **OK**.
- 2 Use ▲▼ to select **Wirelessconnect code**, then press **OK**.
 - Write down the 12-digit code displayed on the screen. You will need this to download Philips Wirelessconnect software.
- 3 Start your internet browser on your PC and open the Philips Wirelessconnect download page at www.wifimediconnect.philips.com/
On the website, you can check the necessary PC system requirements.
- 4 Enter the 12-digit code you wrote at step 2.
- 5 Click the 'Download now' button to download the free Philips Wirelessconnect software.
- 6 Once downloaded, run the Philips Wirelessconnect software installer. Follow the instructions on the screen to complete software installation.

Using Philips Wirelessconnect

- 1 Launch Philips Wirelessconnect on your PC first.
 - Right on the  and select "Start Projecting".
 - The start up screen for Philips Wirelessconnect will be displayed and the unit searches for an available PC that is running Philips Wirelessconnect software.

Once connected, the Philips Wirelessconnect software will encode and stream the screen of your PC as a video along with audio. Depending on your computer and network configuration, there will be a delay between your PC screen and the TV but the audio-video will always be in sync.

Note

- If the "Start Projecting" is not available, please allow Wirelessconnect access through your firewall software on the computer.

Philips Wirelessconnect Help

To read the Philips Wirelessconnect Help, right click the program icon in the notification tray of the PC and select Help.

Specifics

You can project high definition (HD) or standard definition (SD) video, depending on the processing power of your PC. For smooth playback of HD video, please use a hardware accelerated video player on your computer. A hardware accelerated video player uses the graphics adapter of your PC to render HD video rather than the processor. This frees up the processor for Philips Wirelessconnect video encoding. The content protection on most DVD or Blu-ray Disc movies might restrict watching the movie on TV when the disc is playing on a PC. The TV shows PC media files with a small delay. Philips Wirelessconnect is only available for PC.

PC requirements

Windows XP, Windows Vista, Windows 7, Windows 8
Mac OS X 10.6 or above

Minimum PC requirements

- Intel® Core™ 2 Duo 1.8GHz
- 512MB RAM
- IEEE 802.11n

Recommended PC requirements

- Intel® Core™ 2 Duo 2.1GHz
- 1GB RAM

View photos, play music and watch videos using DLNA

On your TV you can play video, music and photo files stored on DLNA certified home media servers connected to your home network. In order to use this feature, you must connect this unit to the Internet.

It is recommended that files to be played back in this unit are recorded under the following specifications:

<MP3>

- Sampling frequency: 32kHz or 44.1kHz or 48kHz
- Constant bit rate: 32kbps - 320kbps

<JPEG>

- Upper limit: 16Mpixel

<MPEG>

- Playable codec: MPEG1, MPEG2, MPEG4
- Maximum size of a video: 1920 x 1080
- Audio type: AC3, MPEG1 audio layer 3 (MP3), MPEG1 audio layer 2, LPCM

Note

- A maximum of 1,023 folders or files can be recognized.
- For the home server list, maximum of 16 servers can be displayed.
- The 10th and deeper hierarchies cannot be displayed.
- Unplayable files in the home server will not be displayed in the file list.
- For some files, playback is not available even if displayed in the file list.
- In order to play back the contents in home servers, the player and the servers must be connected to the same access point.
- Compatibility and available playback function may differ depending on the home server.
- Video files with unsupported audio format will be skipped.
- The quality of the playback picture or audio differs depending on your network condition

Before using DLNA

Follow the procedure below before using DLNA.

- 1 Connect this unit to the Internet.
 - **Connecting the TV to the Internet using an Ethernet cable** → p.15
 - **Connecting the TV to the Internet using a wireless LAN** → p.16
 - Broadband Internet connection of 8Mbps or faster is required.
- 2 Set up the necessary network connection settings. **Network** → p.37

Using DLNA

- 1 Start DLNA home media servers in your home network.
 - For details, refer to the instruction book of the DLNA certified device.
- 2 Press  (MENU) on the remote control.
- 3 Use ▲▼◀▶ to select **Browse PC**.
 - This unit will start loading the home server list.
- 4 After loading, home server list will appear. Select a home server you want to access, then press **OK**.

Guide to DLNA

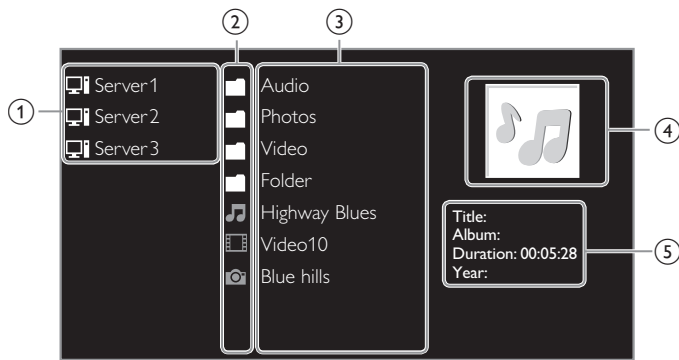

- ① Home server list
- ② Folder / media icon
- ③ Group (folder) / file list
- ④ Image
- ⑤ Current file info

View your pictures using DLNA

- 1 Press ▲▼ to select a file or a folder.
- 2 Press OK or ►|| to start a Slide show of the files.
 - Press OK or ►|| to pause the Slide show. The || icon appears.
 - Press ◀◀ or ▶▶ to move between images.
 - Press BACK or ■ to stop the Slide show.
 - Press ☰ OPTIONS to display the optional menu, then use ▲▼ to select the desired item.

| | | |
|---------------------------|------------|--|
| Slide time* ¹ | Short | Switches to the next image in 5 seconds. |
| | Medium | Switches to the next image in 10 seconds. |
| | Long | Switches to the next image in 15 seconds. |
| Transitions* ¹ | None | No effect when switching images. |
| | Dissolve | Overlaps a next image on a current image. |
| | Wipe right | Pushes a current image out from left. |
| | Wipe left | Pushes a current image out from right. |
| | Wipe up | Pushes a current image out from bottom. |
| | Wipe down | Pushes a current image out from top. |
| | Box in | A next image comes into the center from out. |
| | Box out | A next image goes to the out from center. |
| Rotate* ² | 0 | Displays an image at its original direction. |
| | 90 | Rotates an image clockwise by 90 degrees. |
| | 180 | Rotates an image clockwise 180 degrees. |
| | 270 | Rotates an image clockwise 270 degrees. |
| Zoom* ² | 1X | Displays an image at its original size. |
| | 2X | Magnifies a current image as twice. |
| | 4X | Magnifies a current image as fourfold. |

*¹ You can set **Slide time** and **Transitions** when images are in Slide show.

*² You can set **Rotate** and **Zoom** when Slide show is in pause mode.

Listen to music using DLNA

- 1 Press ▲▼ to select a file or a folder.
- 2 Press OK or ►|| to play the selected files.
 - Press OK or ►|| to pause, press OK or ►|| again to resume.
 - Press ▶▶ to skip up the next file.
 - Press ◀◀ to skip down the previous file.
 - Press ■ to stop playback.
 - Press ☰ OPTIONS to display the optional menu, then use ▲▼ to select the desired item.

| | | |
|-------------|-------------------|---|
| Repeat | Off | Sets repeat playback to off. |
| | On | Sets repeat playback for all MP3 files in the current folder. |
| Shuffle | Off | Sets shuffle playback to off. |
| | On | Sets shuffle playback for all MP3 files in the current folder. |
| TV speakers | Off | The sound will not be output from the unit's speakers. |
| | On | The sound will be output from the unit's speakers. |
| | Speakers EasyLink | You can control audio output from your connected EasyLink Compliant Devices with VOL + / - by using this unit's remote control. |

Note

- Master EasyLink must be activated in the Preferences menu to make the TV speakers menu available when you select On or Speakers EasyLink.

Watch videos using DLNA

- 1 Press ▲▼ to select a file or a folder.
- 2 Press OK or ►|| to play the selected files.
 - Press OK or ►|| to pause, press OK or ►|| again to resume.
 - Press ▶▶ to fast-forward search.
 - Press ◀◀ to fast-backward search.
 - Press ■ to stop playback. Press ►|| to resume from the point at which playback was stopped. Press OK to play from the beginning of the file at which playback was stopped.
 - Press CH + to play the next file.
 - Press CH - to play the current file at the beginning. Press CH - twice within 5 seconds to play the previous file.
 - Press ☰ OPTIONS to display the optional menu, then use ▲▼ to select the desired item.

| | | |
|-------------|-------------------|---|
| TV Speakers | Off | The sound will not be output from the unit's speakers. |
| | On | The sound will be output from the unit's speakers. |
| | Speakers EasyLink | You can control audio output from your connected EasyLink Compliant Devices with VOL + / - by using this unit's remote control. |

Note

- The resume information will be kept even when the unit is Turned Off.
- If you play another file while the previously viewed file is being resumed, the resume information of the previously viewed file will be deleted.

Net TV

Net TV offers Internet services for your TV. Use the TV remote control to browse the Net TV pages. You can play movies, listen to music and much more, all from your TV screen.

- Because Net TV is an online system, it can be modified over time to better serve its purpose.
- Some Net TV services can be added, changed or stopped after some time.
- You cannot download and save files or install plug-ins.

Before Logging in to Net TV

Follow the procedure below before logging in to Net TV.

- 1 Connect this unit to the internet.
- 2 Set up the necessary network connection settings. **Network** → p.37

Logging in to Net TV

- 1 Press **NET TV**.
 - Net TV screen will appear; then use **▲▼◀▶** to select service icon.
 - For the first time only, **Philips Terms of Use Internet Enabled product** screen will appear. After confirming the content, use **◀▶** to select **Agree**, then press **OK**.

Guide to Net TV screen

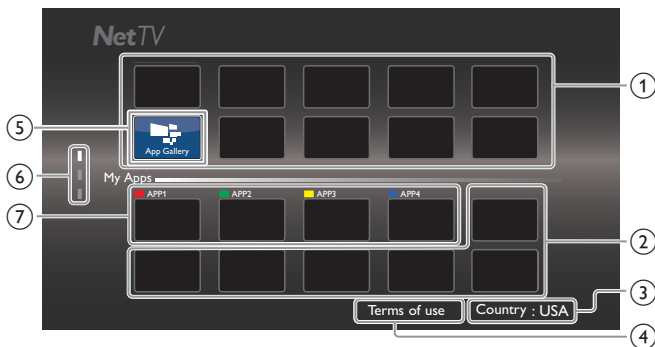

- 1 Net service icons (fixed): Displays default service icons.
- 2 My Apps list: Displays Net service icons you have listed in **App Gallery**.
- 3 Country: Selects what country you live.
- 4 Terms of use: Displays a clause of Net service.
- 5 App Gallery: Displays currently available Net service icons in your country.
- 6 Page guide: Displays the order of pages. The current page will be highlighted.
- 7 APP1 / APP2 / APP3 / APP4: Displays Net service icons you have registered in **App Gallery** for **APP1 / APP2 / APP3 / APP4**.
 - Press **Apps** buttons (red / green / yellow / blue) to start up **APP1 / APP2 / APP3 / APP4** accordingly.

My Apps functions

Remove App

- 1 Use **▲▼◀▶** to select the desired App, then press **☰ OPTIONS**.
- 2 Use **▲▼** to select **Remove App**, then press **OK**.
 - The selected App will be removed from **My Apps** list.

Move App

- 1 Use **▲▼◀▶** to select the desired App, then press **☰ OPTIONS**.
- 2 Use **▲▼** to select **Move App**, then press **OK**.
 - The selected App icon will be smaller.
- 3 Use **▲▼◀▶** to the point you want to place, then press **OK**.

Guide to App Gallery

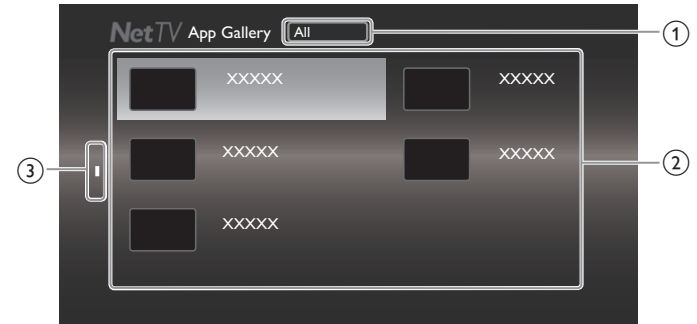

- 1 Category menu: List of category menu.
- 2 Icon list: Displays unregistered Net service icons on **My Apps** list.
- 3 Page guide: Displays the order of pages. The current page will be highlighted.

- 1 Press **NET TV**, then use **▲▼◀▶** to select **App Gallery**.
- 2 Use **▲▼◀▶** to select the desired App in **My Apps** list, then press **OK**.
 - You can also choose from Category menu. Use **▲▼◀▶** to select **All**, then use **▲▼ OK** to select the desired category.
 - If you select **Add**, the selected App icon will be placed at the end of **My Apps** list.
 - If you select **Add and move**, the selected App icon will be smaller and use **▲▼◀▶** to the point you want to place, then press **OK**.
Even if you press **BACK** to cancel this function, the selected App icon will be placed at the end of **My Apps** list.

Information on Network Services

For detailed information on 3rd party Internet services, please visit the service providers website:

Netflix: <http://www.netflix.com/HowItWorks>
 Film Fresh*: <http://filmfresh.roxionow.com/>
 VUDU: http://www.vudu.com/product_overview.html
 Cloud TV: <http://www.activevideo.com>
 Hulu Plus: <http://www.hulu.com>
 CinemaNow*: <http://www.cinemanow.com>

* Film Fresh / CinemaNow is supported in 50PFL3908, 46PFL3908, 40PFL4908, 39PFL2908, 32PFL4908, 29PFL4908 only.

Enjoying vTuner

With this unit, you can enjoy video and Internet radio with vTuner via the Internet. In order to watching video and listen to Internet radio, you must connect this unit to the Internet.

Video playback

After you set up the network connection, follow the procedure below to watch the video.

Guide to the player screen

e.g.) Recommendations

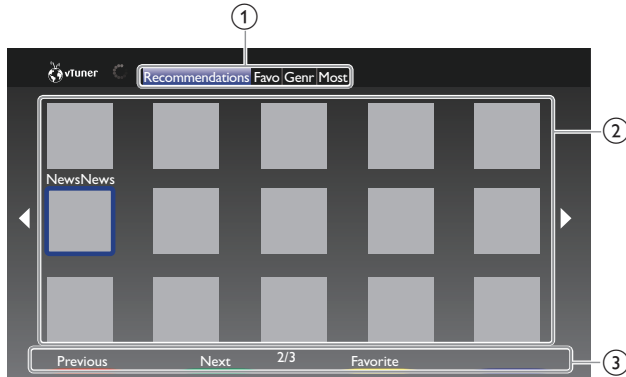

- ① Category: List of category menus
Recommendations: List of recommendation stations
Favorites: List of your favorite video stations
Genre: List of stations categorized by genre
Most Popular Podcasts: List of popular podcasts
 - ② Station list: Displays station list.
 - ③ Operation guide: Displays **Apps buttons** (red / green / yellow / blue) guide.
- 1 Press **NET TV** on the remote control and then use **▲▼◀▶** to select **vTuner Video**.
 - 2 Use **◀▶** to select the desired category, then press **OK**.
 - 3 In the player screen, use **▲▼◀▶** to select the desired station or genre, then press **OK**.

Guide to the playback screen



- ① Station icon
- ② Station name
- ③ Station information
- ④ Episode list
- ⑤ **Apps buttons** (red / green / yellow / blue) guide
- ⑥ Current episode information

- 4 In the playback screen, use **▲▼** to select the desired episode, then press **OK**.
 - After loading, playback of the selected episode will start.
 - To stop playback, press **■**.
 - Episode list can be displayed 5 episodes at one time. To show the previous / next episodes, press **Apps buttons** (red / green).
 - To enlarge playback screen, press **Apps button** (blue).

Note

- Video service may not be fully available with narrowband Internet connection. (e.g. 56k modem) When watching video, use broadband Internet connection. (For details, contact your Internet service provider.)
- Depending on the bit rate of a station or the network environment, it may take a while to complete loading the station or playback may not be available.
- The streaming video may be interrupted during playback, when the vTuner server is busy.
- Some stations cannot be displayed in the list, depending on the network environment.
- If the loading time of a station exceeds 3 minutes, the loading will be canceled.
- The order of station / episode in the list depends on the information from vTuner server and may change without notice.

Add to Favorites

You can add your favorite stations to **Favorites** in the category tab. To add your favorite stations, follow the procedure below.

- 1 Follow steps 1 to 2 in **Video playback**. → p.46
- 2 Use **▲▼◀▶** to select the station you want to add to **Favorites**, then press **Apps button** (yellow).
 - The selected station is added to the station list in **Favorites**.
 - Confirmation message will appear.
 - Press **Apps button** (yellow) to add your favorite station in **Favorites** while the desired episode is selected in the episode list or the episode is being played back.
- 3 Press **OK**.

Remove from Favorites

- 1 Follow step 1 in **Video playback**. → p.46
- 2 Use **◀▶** to select **Favorites** in the category tab, then press **OK**.
- 3 Use **▲▼◀▶** to select the station you want to remove from **Favorites**, then press **Apps button** (yellow).
 - Confirmation message will appear.
- 4 Use **◀▶** to select **Yes**, then press **OK**.
 - The selected station is removed from **Favorites**.

Internet radio playback

After you set up the network connection, follow the procedure below to listen to Internet radio.

Guide to the playback screen

e.g.) Location



- ① Current hierarchy (total number of items)
- ② Current station information
(Information will be changed when **i** INFO is pressed)
- ③ **Apps** buttons (red / green / yellow / blue) guide
- ④ Station list
- ⑤ Playback status
- ⑥ Station icon

- 1 Press **NET TV** on the remote control and then use **▲▼◀▶** to select **vTuner Radio**.
 - Category list will appear.
- 2 In the category list, use **▲▼** to select the desired category, then press **OK**.
 - Station / folder list of selected category will appear.
 - For **Location** and **Genre**, use **▲▼** to select the desired location or genre after selecting the category, then press **OK**.

| | |
|-----------------------|--|
| Recently Played | List of stations which are recently played |
| Favorites | List of your favorite radio stations |
| My Added Stations | List of stations which are added on vTuner website (This category will appear only after you add stations on vTuner website.) |
| Location | List of stations categorized by location |
| Genre | List of stations categorized by genre |
| New Stations | List of the latest stations which are recently added automatically. |
| Most Popular Stations | List of the most frequently accessed stations by the all listeners. |

- 3 In the station / folder list, use **▲▼** to select the desired station, then press **OK**.
 - After loading, playback of the selected station will start.
 - If you select a folder, use **▲▼** to select the desired station in the next hierarchy, then press **OK**.
 - To stop playback, press **■**.
 - To go back to the previous or next hierarchy, press **◀▶**.

Note

- This unit cannot play back stations with audio format other than MP3 and WMA.
- Internet radio service may not be fully available with narrowband Internet connection. (e.g. 56k modem) When listening to Internet radio, use broadband Internet connection. (For details, contact your Internet service provider.)
- Depending on the bit rate of a station or the network environment, it may take a while to complete loading the station or playback may not be available.
- The streaming audio may be interrupted during playback, when the vTuner server is busy.
- Some stations cannot be displayed in the list, depending on the network environment.
- If the loading time of a station exceeds 3 minutes, the loading will be canceled.
- The order of station / folder in the list depends on the information from vTuner server and may change without notice.

Add to favorite list

You can add your favorite stations to **Favorites** in the category list. To add your favorite stations, follow the procedure below.

- 1 Follow steps 1 to 3 in **Internet radio playback**. → p.47
- 2 Use **▲▼** to select the station you want to add to Favorites, then press **Apps** button (yellow).
 - The selected station is added to **Favorites** folder.
 - Confirmation message will appear.
 - If you select a folder, use **▲▼** to select the desired station in the next hierarchy, then press **Apps** button (yellow).
- 3 Press **OK**.

Note

- You can also add your favorite stations to **Favorites** on your PC. To add your favorite stations on your PC, visit <http://go2service.vtuner.com/pe/> and create a vTuner account with the access code, which you can check from the category list. **Internet radio playback**. → p.47
- You can change folder names or order of lists in your vTuner page on the Internet.
- **My_Favorite** folder will appear after you add a station to **Favorites** on this unit. (Your favorite station will also be added to **My_Favorite** folder.)

Remove from favorite list

- 1 Follow step 1 in **Internet radio playback**. → p.47
- 2 Use **▲▼** to select **Favorites**, then press **OK**.
- 3 Use **▲▼** to select the station you want to remove from **Favorites**, then press **Apps** button (yellow).
 - Confirmation message will appear.
- 4 Use **◀▶** to select **Yes**, then press **OK**.
 - The selected station is removed from **Favorites** folder.

Add stations on the vTuner website

You can add stations which are not in the vTuner station list.

- 1 Follow step 1 in **Internet radio playback**. → p.47
- 2 Use **▲▼** to select **Get access code**, then press **OK**.
 - The latest vTuner website address and access code for this unit will be displayed. Please take a note of the access code. (This access code will be required when creating a vTuner account.)
- 3 On your PC, visit the website and create your vTuner account.
 - Follow the instructions given on the PC screen.
- 4 Add stations by following the instructions given on the PC screen.
 - The stations will be added to **My Added Stations**.

Reset the station list

You can remove all stations / folders in **Recently Played**, **Favorites** and **My Added Stations**.

- 1 Follow step 1 in **Internet radio playback**. → p.47
- 2 Use ▲▼ to select **Reset**, then press **OK**.
- 3 Use ◀▶ to select **Yes**, then press **OK**.
 - All stations / folders in **Recently Played**, **Favorites** and **My Added Stations** are removed.

Pandora® operations

With this unit, you can instantly listen to personalized radio stations streamed over the Internet from Pandora.

To learn more about Pandora, please visit www.pandora.com

Activating Pandora

In order to listen to Internet radio streamed from Pandora via the Internet, you must create a Pandora account and activate this unit.

- 1 Press **NET TV**, then use ▲▼◀▶ to select **PANDORA**.
- 2 Use ▲▼ to select **Create new account**, then press **OK**.
- 3 Use ▲▼ to select **No, I am new to Pandora.**, then press **OK**.
- 4 Note the activation code and website address displayed on the TV screen.
- 5 On your PC, visit the website address noted at step 4.
- 6 Follow directions on the website to create your account.
- 7 On this unit, select **Continue** and press **OK** to complete activation.

Adding Pandora User Accounts

You can add multiple Pandora user accounts on this unit.

- 1 Follow steps 1 to 2 in **Activating Pandora**. → p.48
- 2 Use ▲▼ to select **Yes, I have a Pandora account**, then press **OK**.
- 3 Enter your e-mail address, then press **OK** while **OK** is selected.
- 4 Enter a password, then press **OK** while **OK** is selected.
- 5 Use ▲▼ to select **Sign In**, then press **OK**.
 - Your account is added to the user list and player screen appears on the TV screen.

Note

- Pandora is available only in the United States.
- You can add up to 5 accounts. After creating 5 accounts, **Create new account** will not be displayed.

Creating a New Station

By entering your favorite artists or tracks, Pandora selects music and creates a new station for you on the basis of the entered information.

- 1 On the player screen, press **Apps button (yellow)** to call up the **Tool Menu**.
- 2 Use ▲▼ to select **Create a new station.**, then press **OK**.
- 3 Enter a name of your favorite artist or tracks, then press **OK** while **OK** is selected.
 - Search result will appear on the right side of the TV screen.
 - If the selection screen of result type appears, use ▲▼ to select the desired type, then press **OK**.
- 4 Use ▲▼ to select the desired station, then press **OK** to start the playback.

| | |
|----|--|
| ▶ | Resumes the playback / pause the playback. |
| ■ | Stops the playback and the station list will appear. |
| ▶▶ | Skips to the next track. |





Note

- On the **Tool Menu**, you can delete or rename the currently selected station.

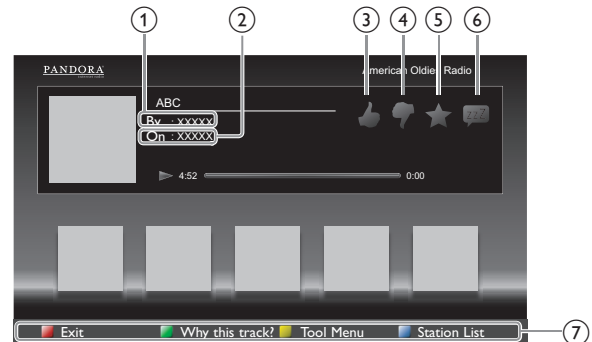
Guide to the Player Screen

On the player screen, you can set various options to the currently playing track.



- ① Artist name : Displays artist name.
- ② Album name : Displays album name.
- ③  : Give thumbs up to the currently playing track. Pandora will play tracks similar to the track.
- ④  : Give thumbs down to the currently playing track. Pandora will skip and will not play the track.
- ⑤  : Bookmarks the currently playing track. You can view your bookmarked tracks list by accessing Pandora website and log into your account.
- ⑥  : Tells Pandora that you do not like the currently playing track. Pandora will not play the track for about a month.
- ⑦ Operation guide : Displays **Apps buttons (red / green / yellow / blue)** guide.

6 Useful tips

FAQ

| Question | Answer |
|--|--|
| My remote control does not work. What should I do? | <ul style="list-style-type: none"> • Check the antenna or cable connection to the main unit. • Check the batteries of the remote control. • Check if there is an obstacle between the infrared sensor window and the remote control. • Test the signal Output use IR Signal Check → p.52 If okay, then possible infrared sensor trouble. • Aim the remote control directly at the infrared sensor window on the front of the unit. • Reduce the distance to the unit. • Re-insert the batteries with their polarities (+/-) as indicated. • When there is an infrared-equipped device such as PC near this unit, it may interrupt the remote control signal of this unit. Move the infrared-equipped device away from this unit, change the angle of the infrared sensor or Turn Off the infrared communication function. |
| How come the Initial setup appears every time I Turn On this unit? | <ul style="list-style-type: none"> • Make sure to complete the initial setup before the unit goes into Standby mode. |
| Why can I not watch some RF signal TV programs. | <ul style="list-style-type: none"> • Autoprogram must be completed when you set up the unit for the first time or move it to a location where previously unavailable channels are broadcast. • Make sure Autoprogram has been completed. → p.34 • The selected channel may not be broadcasting. • When Autoprogram is interrupted and not completed, some channels will not be received. Make sure to complete the Autoprogram. → p.34 • The selected channel cannot be viewed by the Child and ratings lock setting. → p.31 • The unit requires some kind of antenna Input. An indoor antenna (Digital or VHF / UHF), an external antenna (Digital or VHF / UHF) or an RF coaxial cable from your wall Cable / Satellite set-top box needs to be plugged into the unit. |
| How come there is no image from the connected external devices? | <ul style="list-style-type: none"> • Check if the correct Input mode is selected by pressing  SOURCE. Watching channels from an external device. → p.21 • Check the antenna, cable or other Input connection to the unit. • When using the Component Video connection check that the Green (Y), Blue (Pb/Cb) and Red (Pr/Cr) connectors are connected to their corresponding colored jacks on the unit. |
| When I enter a channel number, it changes automatically. | <ul style="list-style-type: none"> • Many Digital channels have alternate channel numbers. The unit changes the numbers automatically to the ones signifying the broadcasting station channel number. These basic numbers used for previous Analog broadcasts. (e.g., Input ch# 30 automatically changes to ch# 6.1) |
| Why are captions not displayed entirely? Or, captions are delayed behind the dialog. | <ul style="list-style-type: none"> • Captions that are delayed a few seconds behind the actual dialog are common for live broadcasts. Most captioning production companies can display a dialog to maximum of 220 words per minute. If a dialog exceeds that rate, selective editing is used to insure that the captions remain up-to date with the current TV screen dialog. |
| How can I set the clock? | <ul style="list-style-type: none"> • There is no clock function on this unit. |
| I cannot change the Child lock setting because my PIN code no longer works. | <ul style="list-style-type: none"> • Although the default PIN code (0000) is supplied with the unit, the PIN code will be required once you set a PIN code in Child and ratings lock. → p.31 When you forget your PIN code, enter 0711 in Change PIN to reset the PIN code. → p.33 |
| How come the "Software update failed." message appears when I Turn On this unit? | <ul style="list-style-type: none"> • The unit will not work correctly unless the software upgrade is completed. Try Recovery update. → p.41 |

Troubleshooting

If the unit does not perform properly when operated as instructed in this User Manual, **check the following Troubleshooting tips and all connections once before calling for service.**

Power

No power

- Make sure the AC power cord is plugged in.
- Make sure that the AC outlet supplies the proper voltage, plug another electrical appliance into the AC outlet to ensure that the AC outlet operates normally.
- If a power failure occurs, unplug the AC power cord for 1 minute to allow the unit to reset itself.

Remote

Control buttons do not work.

- Press only one button at a time. Do NOT press more than one button at the same time.
- Ensure that no buttons on the remote control are depressed and move freely.

Universal remote control does not work properly.

- Refer to the user manual of the universal remote control for the Philips code.

Picture

Power is ON but no screen image.

- Check whether the connection of the antenna, cable receiver or satellite box is connected correctly.
- Check whether all the cables to the unit are connected to the correct Output jack of your device like Blu-ray / DVD recorder.
- Make sure that the selected Input mode is connected to the working Input jack.
- Check if your computer is NOT in sleep mode when the Input mode of this unit is in PC mode. Tap any key on the keyboard to wake up your computer.
- Check if the correct input mode is selected by pressing  **SOURCE**.

No color

- View other TV channels. The problem might be limited to the broadcasting station or weak signal strength.
- Adjust **Color** in **Picture** settings. → p.27

Picture poor; sound OK

- Electrical interference from nearby appliances may affect picture quality when viewing an off-the-air low power NTSC analog broadcast signal.
- Adjust **Contrast** and **Brightness** in **Picture** settings. → p.27
- View other TV channels. The problem might be limited to the broadcasting station or weak signal strength.
- For the best picture quality, watch "High Definition" wide screen programs. If the HD content is not available, watch "Standard Definition" programs instead.

You see noise or trash on the screen.

- When the capabilities of the unit exceed the capabilities of the Digital broadcasting, the signal will be increased to match the capabilities of the display of the unit. This may cause noise or trash.
- When viewing an off-the-air low power NTSC Analog broadcast signal may show noise or trash on the screen.

Unusual picture appears and the TV does not operate.

- Press the power button first. If it does not solve, follow the procedure below.
 - 1 Press the buttons on the remote control in the order shown below.

 - 2 Unplug the AC power cord once, and wait for 1 minute, and then plug it in again.

Picture & Sound

No picture or sound

- Check if the Power is on.
- Check whether all the cables to the unit are connected to the correct Output jack of your device like Blu-ray / DVD recorder.
- View other TV channels. The problem might be limited to the broadcasting station or weak signal strength.
- Unplug the AC power cord and wait for about 1 minute, then plug the AC power cord and Turn On the unit again.
- Check whether the connection of the Antenna or Cable / Satellite set-top box is connected correctly.
- Make sure that the selected Input mode is connected to the working Input jack.
- Check if your computer is NOT in sleep mode when the Input mode of this unit is in PC mode. Tap any key on the keyboard to wake up your computer.
- Make sure that the sound is not muted. Press  (MUTE) so that the volume bar and current volume level will appear on the TV screen.

- Make sure that the volume is NOT set to 0 or . If so, use **VOL + / -** to adjust to the desired volume.
- Make sure that the headphone is NOT connected to the Headphone Audio Output jack.
- Make sure that the **TV speakers** is NOT set to **Off**.

Adjusted **Picture** or **Sound** settings are not effective every time the unit is turned On.

- You must set to **Home** in **Location**. → p.35
Otherwise, the settings you adjusted will not be memorized after the unit goes into Standby mode.

You see a distorted picture or hear an unusual sound.

- You may be getting NTSC TV signal (not HDTV signal) interference from electrical appliances, automobiles, motorcycles or fluorescent lights.
- Try moving the unit to another location to see if this is the cause of the problem.

Ghosts, lines or streaks in picture.

- Electrical interference from nearby appliances may affect picture quality when viewing an off-the-air low power NTSC analog broadcast signal.
- View other TV channels. The problem might be limited to the broadcasting station or weak signal strength.

Sound

No sound, distorted sound or incorrect Audio Sound is heard when using the HDMI-DVI connections.

- Make sure that the Analog Audio signals from the HDMI-DVI device are connected to the Analog Audio Input L/R jacks.
- When using Component Analog Video, Composite Analog Video or PC VGA Video make sure that the Analog Audio (L/R) connectors are mounted into the Audio (L/R) Input jacks.

Sound poor; picture OK

- View other TV channels. The problem might be limited to the broadcasting station or weak signal strength.
- Check if the audio cable is connected incorrectly.

You switch to a different Input and the volume changes.

- This unit will memorize the volume level from the last time you adjusted it.
- If the volume of the sound from another device is higher or lower, then the loudness will change.
- Make sure **Auto volume leveling** is set to **On**. → p.29

Child and Rating Lock

Forgotten PIN code.

- Enter "0711" to clear your password.

Screen

You switch to a different Input and the screen size changes.

- This unit will memorize the viewing mode from the last time you used the particular input modes.

The display image does not cover the entire screen.

- If you are using the unit as a PC monitor; make sure that **Horizontal position** and **Vertical position** in **Picture** are set correctly. → p.27
- If you are watching TV or using the Composite Video, Component Video or HDMI with 480i Input, press  **FORMAT** repeatedly to switch various screen modes.

Different color marks on the TV screen.

- View other TV channels. The problem might be limited to the broadcasting station, missing data or pixelation.

Captions

Captions are displayed as a white box. No caption is displayed in the closed caption-supported program.

- Interference from buildings or weather conditions may cause captioning to be incomplete if watching Analog TV (NTSC) signals.
- Broadcasting station may shorten the program to insert advertisements. The closed caption decoder cannot read the information of the shortened program.
- Captions that are delayed a few seconds behind the actual dialog are common for live broadcasts.
Most captioning production companies can display a dialog to maximum of 220 words per minute. If a dialog exceeds that rate, selective editing is used to insure that the captions remain up-to date with the current TV screen dialog.

Black box is displayed on the TV screen.

- The text mode is selected for caption. Select **CC-1**, **CC-2**, **CC-3**, or **CC-4**.

Software update

"Software update failed." message appears when the unit is turned On.

- The unit will not work correctly unless the software upgrade is completed. Try **Recovery update**. → p.41

Network

Cannot connect to the network.

- Check if the Ethernet cable connection is properly made. Turn On the modem or broadband router.
- Check the network settings.
- Check if the broadband router and/or modem is correctly connected.

Sometimes video quality is poor when using the wireless LAN.

- The wireless network connection quality varies depending on the distance or obstacles (e.g. wall, basement, 2nd floor) between the TV Wireless LAN Adapter and the wireless router (access point), from other wireless networks, and brand and type of the wireless router (access point). When using the Wireless LAN of the TV, it is suggested to place the wireless router as close as possible to the Television.

Wireless LAN connection fails or wireless connection is poor.

- Check the installation location of the TV and wireless router (access point). Signal quality may be affected for the following reasons.
 - Interference of other wireless devices, microwaves, fluorescent lights, etc., are placed nearby.
 - There are floors or walls between the wireless router and TV.
 - If the problems continue even after checking the above, try making a wired LAN connection.

Cannot use the wireless connection.

- Check if the Wireless LAN Access Point (AP) (e.g. wireless router) is oriented properly or not placed too close between them.
- Once you have activated the wireless connection please wait 30 seconds for the connection to be established after Turning On the unit, before trying to access network features such as Net TV.

Cannot use Netflix feature.

- Netflix is available only in the United States and Canada.
- Check if the network connection is properly made.
- Visit <http://www.netflix.com/HowItWorks> on your PC and become a Netflix member.

Cannot use Hulu Plus feature.

- Hulu Plus is available only in the United States.
- Check if the network connection is properly made.

Cannot add movies or TV episodes to the Instant Queue.

- Visit www.netflix.com on your PC.

Even though the speed of the Internet connection improves during playback, the picture quality of Netflix streaming movie does not improve.

- The picture quality does not change during playback. It differs depending on the speed of Internet connection at the time of loading.

Cannot use VUDU feature.

- VUDU is available only in the United States, Canada and Mexico.
- Check if the network connection is properly made.

Cannot rent or buy movies / TV episodes on VUDU.

- You need to activate the VUDU account. For detailed information, please visit the service provider's website at http://www.vudu.com/product_overview.html
- Log into your account at <http://my.vudu.com> and check your payment information.

The picture quality of streaming movie (Netflix, Hulu Plus, Film Fresh or VUDU) is poor.

- Check the speed of your Internet connection. You need speeds of at least 8 Mbps to this player for high quality uninterrupted playback.

Streaming movie (Netflix, Hulu Plus, Film Fresh or VUDU) often stops or starts buffering during playback.

- Contact your Internet service provider to troubleshoot your Internet connection for speed and line quality. Consistent line quality and speed are very important for Internet video playback.

Cannot connect to the network while my PC is connected to the network.

- Check the content of your Internet service contract to see if your Internet Service Provider prevents multiple terminals connecting at the same time.

Cannot use **Easy connect** (WPS) to connect to the Access Point.

- Connect the unit to the Access Point using Scan or Manual entry mode. If the Access Point's security mode is set to WEP*, change the setting to WPA or WPA2 (recommended), then try Easy connect (WPS) again. (For Access Point configuration, please consult its user manual or manufacturer.)

* WEP is not recommended to be used due to its Major security flaws. Change the Security protocol on the wireless router to WPA or WPA2 (recommended) mode.

Folder or files stored on DLNA home media server are not displayed in the file list or cannot be played back.

- Check the setting on your home media server. (Refer to the user manual of the home media server.)
- Check the network connection and settings.

Cannot use Film Fresh feature.

- Film Fresh is available only in the United States.
- Check if the network connection is properly made.
- Visit <http://filmfresh.roxionow.com/> (Film Fresh) on your PC and create an account.

Cannot use Pandora feature.

- Check if the network connection is properly made.
- Pandora is available only in the United States.
- You must create a Pandora account and activate this unit. **Activating Pandora** → p.48

The audio of Internet radio station interrupted.

- vTuner server, station or the Internet connection is busy. The bit rate of the station is high.

Cannot play back Internet radio.

- Check if the network connection is properly made.
- Check the firewall setting of the modem or router.
- For some stations, playback is not available on this unit.

The quality of the Internet radio audio is poor or noise occurs during playback of Internet station.

- The bit rate of the station is low.

Cannot get into the PC's screen even the Philips Wirelessconnect is launched.

- Make sure if the network connection is connected properly.
- Check if your PC runs Philips Wirelessconnect.
- Make sure your TV and PC are connected on the same network.

I have a 1.8GHz CPU but Wirelessconnect does not work on my PC.

- For smooth operation of your PC while Philips Wirelessconnect is running you need a mainstream dual core processor from Intel® or AMD. Intel® : Core™2 Duo or Core™ i3/5/7 @ 1.8GHz or higher. AMD : Athlon™ II X2, Turion™ II Dual-Core or Phenom™ X2 @ 2GHz or higher.

Note

- The LCD screen is manufactured to provide many years of useful life. Occasionally a few non active pixels may appear as a fixed point of blue, green or red. This is not to be considered a defect in the LCD screen.
- Some functions are not available in specific modes, but this is not a malfunction. Read the description in this User Manual for more details on correct operations.

7 Information

Glossary

Analog TV (NTSC)

Acronym that stands for National Television Systems Committee and the name of Analog broadcasting standards. Off the air NTSC signals are no longer being sent by major broadcasting stations in the USA.

ARC (Audio Return Channel) (HDMI 1 only)

HDMI-ARC allows you to use Philips EasyLink to output TV audio directly to a connected Audio device, without the need for an additional Digital Audio cable. Be sure that the device is HDMI CEC and ARC compliant, and that the TV is connected to the device using an HDMI cable attached to both HDMI-ARC connectors.

Aspect ratio

The width of a TV screen relative to its height. Conventional TVs are 4:3 (in other words, the TV screen is almost square); widescreen models are 16:9 (the TV screen is almost twice as wide as its height).

CEC (Consumer Electronics Control)

This allows you to operate the linked functions between our brand devices with CEC feature and this unit. We do not guarantee 100% interoperability with other brands of CEC compliant devices.

Component Video

This is a video signal format that conveys each of 3 principal colors of light (red, blue and green) through different signal lines. This allows the viewers to experience picture colors as original as it is. There are several signal formats, including Y / Pb / Pr and Y / Cb / Cr.

Dolby Digital

The system developed by Dolby Laboratories to compress Digital sound. It offers stereo sound (2ch) or multi-channel audio.

DTV (ATSC)

Initialism that stands for Advanced Television Systems Committee and the name of the Digital broadcasting standards.

E-sticker

E-sticker is showing set features, technical information, etc on this TV set that is displayed on the TV screen mainly used by TV retailers. Previously the information was on a printed sticker that was put on the display.

HDMI (High-Definition Multimedia Interface)

Interface that supports all uncompressed, Digital Audio / Video formats including set-top box, Blu-ray / DVD recorder or Digital television, over a single cable.

HDTV (High Definition TV)

Ultimate Digital format that produces high resolution and high picture quality.

PIN code

A stored 4-digit number that allows access to parental control features.

SAP (Secondary Audio Program)

Second-audio channel delivered separately from main-audio channel. This audio channel is used as an alternate in bilingual broadcasting.

SDTV (Standard Definition TV)

Standard Digital format that is similar to the Analog TV (NTSC) picture quality.

SRS TruSurround HD™

Creates an immersive, feature-rich surround sound experience from two speakers, complete with rich bass, high frequency detail and clear dialog.

Maintenance

Cabinet Cleaning

- Wipe the front panel and other exterior surfaces of the unit with a soft cloth.
- Never use a solvent or alcohol. Do not spray insecticide liquid near the unit. Such chemicals may cause damage and discoloration to the exposed surfaces.

Panel Cleaning

Wipe the panel of the unit with a soft cloth. Before cleaning the panel, disconnect the AC power cord.

Servicing

Should your unit become inoperative, do not try to correct the problem yourself. There are no user serviceable parts inside. Call our toll free customer support line found on the cover of this User Manual to locate an authorized service center.

IR Signal Check

If the remote control is not working properly, you can use a Digital camera (including a cellular phone with built-in camera) to see if it is sending out an infrared signal.



With a Digital camera (including built-in cell phone cameras): Point the Digital Camera towards the remote control infrared diode at the front of the remote control. Press any button on the remote control and look through the camera display. If the infrared pulsating light appears through the camera, the remote control is sending out an IR signal.

8 Specifications

| Model # | 50PFL3908 | 46PFL3908 / 46PFL3608 | 40PFL4908 | 39PFL2908 / 39PFL2608 | 32PFL4908 | 29PFL4908 |
|--|--|--|----------------------|-----------------------|---|--------------------------------------|
| Picture | | | | | | |
| Type | FHD (1920 × 1080 pixels 60Hz) | | | | WXGA (1366 × 768 pixels 60Hz) | |
| Diagonal screen size / Aspect ratio | 49.5"/ 16:9 | 46.0"/ 16:9 | 40.0"/ 16:9 | 38.6"/ 16:9 | 31.5"/ 16:9 | 28.5"/ 16:9 |
| Viewing angles | 176° (V) by 176° (H) | 178° (V) by 178° (H) | 176° (V) by 176° (H) | | 178° (V) by 178° (H) | 176° (V) by 176° (H) |
| Built-in Digital / Analog tuner | ATSC (Digital) / NTSC (Analog) | | | | | |
| Sound | | | | | | |
| Mono / Stereo | Mono, Stereo, SRS TruSurround HD™ | | | | | |
| Power Output (RMS watts) | 10 W × 2 | | | 8 W × 2 | | |
| Equalizer | 5 band | | | | | |
| Ease of use | | | | | | |
| Picture format | SD (4:3 Source) | Automatic / Super zoom / 4:3 / Movie expand 14:9 / Movie expand 16:9 / Wide screen | | | | |
| | HD (16:9 Source) | Automatic / 4:3 / Wide screen / Unscaled | | | | Automatic / 4:3 / Wide screen / Full |
| | HDMI AV (4:3 Source) | Automatic / Super zoom / 4:3 / Movie expand 14:9 / Movie expand 16:9 / Wide screen | | | | |
| | HDMI AV (16:9 Source) | Automatic / 4:3 / Wide screen / Unscaled | | | | Automatic / 4:3 / Wide screen / Full |
| | PC Source | 4:3 / Wide screen / Unscaled (Refer to HDMI AV (16:9 Source) above if PC has HDMI Output.) | | | | |
| Photo Slide show | JPEG files only | | | | | |
| MP3 playback | MP3 files only | | | | | |
| Video playback | MPEG1 (.mpg / .mpeg), MPEG2 (.mpg / .mpeg / .vob), H.264 (.mp4), MPEG4 SP/ASP (.avi), MPEG4 (.mp4) | | | | | |
| Channel | | | | | | |
| Channel coverage | Terrestrial DTV (ATSC): | VHF: 2~13 UHF: 14~69 (each channel has e.g. 2.1~2.9, 3.1~3.9, etc) | | | | |
| | Terrestrial Analog (NTSC): | VHF: 2~13 UHF: 14~69 | | | | |
| CATV (Analog NTSC) | 2~13, A~W W+1~W+94 (analog W+1~W+84), A-5~A-1, 5A | | | | | |
| Tuning system | Channel frequency synthesized tuning system | | | | | |
| Channel access | Direct access number keyboard, Programmable scan, and Channel up / down | | | | | |
| Connectivity | | | | | | |
| Component Video Input (Y/Pb/Pr) | 1 supporting video signals : 480i/p, 720p, 1080i 60Hz | | | | | |
| Composite Video Input (shared Y green terminal with Component Video) | 1 | | | | | |
| HDMI Input | 3 supporting video signals : 480i/p, 720p, 1080i/p, 24Hz-60Hz HDMI ARC (HDMI 1 only) | | | | | |
| | PC-Input signal up to FHD (1920 × 1080) | | | | PC-Input signal up to WXGA (1366 × 768) | |
| | | | | | | |
| Audio L/R Input | 1 | | | | | |
| PC Input | via VGA and HDMI | | | | | |
| USB | 1 | | | | | |
| Wireless LAN | Supporting wireless standards : IEEE 802.11 b/g/n (2.4GHz) | | | | | |
| Ethernet port | 1 | | | | | |
| Digital Audio Output | 1 supporting Dolby Digital | | | | | |
| Headphone Output | 1 1/8 inch (3.5mm) | | | | | |
| Power | | | | | | |
| Power requirements | 120V~ AC +/- 10%, 60Hz +/- 0.5% | | | | | |
| Temperature | | | | | | |
| Operating temperature | 41 °F (5 °C) to 104 °F (40 °C) | | | | | |

- Specifications are subject to change without prior notice.

9 Warranty

PHILIPS LIMITED WARRANTY ONE (1) YEAR

WARRANTY COVERAGE:

PHILIPS warranty obligation is limited to the terms set forth below.

WHO IS COVERED:

Philips warrants the product to the original purchaser or the person receiving the product as a gift against defects in materials and workmanship as based on the date of original purchase ("Warranty Period") from an Authorized Dealer. The original sales receipt showing the product name and the purchase date from an authorized retailer is considered such proof.

WHAT IS COVERED:

The Philips warranty covers new products if a defect in material or workmanship occurs and a valid claim is received by Philips within the Warranty Period. At its option, Philips will either (1) repair the product at no charge, using new or refurbished replacement parts, or (2) exchange the product with a product that is new or which has been manufactured from new, or serviceable used parts and is at least functionally equivalent or most comparable to the original product in Philips current inventory, or (3) refund the original purchase price of the product. Philips warrants replacement products or parts provided under this warranty against defects in materials and workmanship from the date of the replacement or repair for ninety (90) days or for the remaining portion of the original product's warranty, whichever provides longer coverage for you. When a product or part is exchanged, any replacement item becomes your property and the replaced item becomes Philips' property. When a refund is given, your product becomes Philips' property.

Note: Any product sold and identified as refurbished or renewed carries a ninety (90) day limited warranty.

Replacement product can only be sent if all warranty requirements are met. Failure to follow all requirements can result in delay.

WHAT IS NOT COVERED - EXCLUSIONS AND LIMITATIONS:

This Limited Warranty applies only to the new products manufactured by or for Philips that can be identified by the trademark, trade name, or logo affixed to it. This Limited Warranty does not apply to any non-Philips hardware product or any software, even if packaged or sold with the product. Non-Philips manufacturers, suppliers, or publishers may provide a separate warranty for their own products packaged with the bundled product.

Philips is not liable for any damage to or loss of any programs, data, or other information stored on any media contained within the product, or any non-Philips product or part not covered by this warranty. Recovery or reinstallation of programs, data or other information is not covered under this Limited Warranty.

This warranty does not apply (a) to damage caused by accident, abuse, misuse, neglect, misapplication, or non-Philips product, (b) to damage caused by service performed by anyone other than Philips or Philips Authorized Service Location, (c) to a product or a part that has been modified without the written permission of

Philips, or (d) if any Philips serial number has been removed or defaced, or (e) product, accessories or consumables sold "AS IS" without warranty of any kind by including refurbished Philips product sold "AS IS" by some retailers.

This Limited Warranty does not cover:

- Shipping charges to return defective product to Philips.
- Labor charges for installation or setup of the product, adjustment of customer controls on the product, and installation or repair of antenna/signal source systems outside of the product.
- Product repair and/or part replacement because of improper installation or maintenance, connections to improper voltage supply, power line surge, lightning damage, retained images or screen markings resulting from viewing fixed stationary content for extended periods, product cosmetic appearance items due to normal wear and tear, unauthorized repair or other cause not within the control of Philips.
- Damage or claims for products not being available for use, or for lost data or lost software.
- Damage from mishandled shipments or transit accidents when returning product to Philips.
- A product that requires modification or adaptation to enable it to operate in any country other than the country for which it was designed, manufactured, approved and/or authorized, or repair of products damaged by these modifications.
- A product used for commercial or institutional purposes (including but not limited to rental purposes).
- Product lost in shipment and no signature verification receipt can be provided.
- Failure to operate per Owner's Manual.

TO OBTAIN ASSISTANCE IN THE U.S.A., CANADA, PUERTO RICO, OR U.S. VIRGIN ISLANDS...

Contact Philips Customer Care Center at:
1-866-309-5962

REPAIR OR REPLACEMENT AS PROVIDED UNDER THIS WARRANTY IS THE EXCLUSIVE REMEDY FOR THE CONSUMER. PHILIPS SHALL NOT BE LIABLE FOR ANY INCIDENTAL OR CONSEQUENTIAL DAMAGES FOR BREACH OF ANY EXPRESS OR IMPLIED WARRANTY ON THIS PRODUCT. EXCEPT TO THE EXTENT PROHIBITED BY APPLICABLE LAW, ANY IMPLIED WARRANTY OF MERCHANTABILITY OR FITNESS FOR A PARTICULAR PURPOSE ON THIS PRODUCT IS LIMITED IN DURATION TO THE DURATION OF THIS WARRANTY.

Some states do not allow the exclusions or limitation of incidental or consequential damages, or allow limitations on how long an implied warranty lasts, so the above limitations or exclusions may not apply to you.

This warranty gives you specific legal rights. You may have other rights which vary from state/province to state/province.

License

P&F USA, Inc. hereby offers to deliver, upon request, a copy of the complete corresponding source code for the copyrighted open source code packages, on an "AS IS" basis, used in this product for which such offer is requested by the respective licenses. This offer is valid up to three years after the product purchase to anyone in receipt of this information. To obtain source code, please contact P&F USA, Inc. You should write to "Open Source Team, P&F USA, Inc., PO Box 2248, Alpharetta, GA 30023-2248. P&F USA, Inc. disclaims any and all warranties and representations with respect to such software and related source code including quality, reliability, usability, and accuracy, and further disclaim all express, implied, statutory or otherwise, including without limitation, any implied warranties of title, non-infringement, merchantability, or fitness for a particular purpose. P&F USA, Inc. shall not be liable to make any corrections to the open source software or source code or to provide any support or assistance with respect to it. P&F USA, Inc. disclaims any and all liability arising out of or in connection with the use of this software and/or source code.



P&F USA, Inc.
PO Box 2248, Alpharetta, GA 30023-2248

P&F Mexicana, S.A. de C.V.
Av. La Palma No. 6, Col. San Fernando La Herradura.
Huixquilucan, Edo. de México. C.P. 52787