

Register your product and get support at
www.philips.com/welcome

8000 series Smart LED TV

40PFL8606
46PFL8606
46PFL8686



User manual

PHILIPS

Contents

1	Getting started	3
1.1	TV tour	3
1.2	Setting up	7
1.3	Keys on the TV	10
1.4	Register your TV	11
1.5	Help and support	12

2	Basics	13
2.1	Remote control	13
2.2	Menus	16
2.3	Watch TV	18
2.4	3D	22
2.5	Connected devices	24
2.6	Subtitles, timers and locks	25

3	Smart TV	26
3.1	Net TV	26
3.2	Interactive TV	29
3.3	Videos, photos and music	30
3.4	Pause TV and recording	32
3.5	Games	34
3.6	Text	35

4	Setup	37
4.1	Picture and sound	37
4.2	Ambilight	39
4.3	Channels	41
4.4	Network	43
4.5	Devices	45
4.6	Universal access	46
4.7	Software	47

5	Connections	48
5.1	First connections	48
5.2	Cables and connections	49
5.3	Connect devices	51
5.4	Connect more devices	59
5.5	Network	64
5.6	SD card	65
5.7	Common interface CAM	66

6	Troubleshooting	67
6.1	Contact information	67
6.2	TV and remote control	68
6.3	TV channels	69
6.4	Picture and sound	70
6.5	Devices	71
6.6	Videos, photos and music	72
6.7	Network	73

7	Specifications	74
7.1	Software	74
7.2	Environmental	75
7.3	Power and reception	77
7.4	Display and sound	78
7.5	Display resolutions	79
7.6	Multimedia	80
7.7	Connectivity	81
7.8	Dimensions and weights	82

Index	83
--------------	-----------

1 Getting started

1.1 TV tour

Smart TV



Connect your Smart TV to the **Internet** and you can rent a movie from your home, browse the Net TV apps, watch programmes you missed or check the TV guide. View your photos and videos from your PC, tablet PC or phone.

Connect a USB Hard Drive and pause a TV broadcast or record your favourite show.

Read more about Smart TV in **Help > Smart TV**.

Read more about setting up the Internet connection in **Help > Setup > Network**.

3D Full HD



On this TV, you can watch 3D programmes and movies in full High Definition resolution with 3D Max.

When 3D programmes are broadcast or you start a 3D movie, the TV switches to 3D. All you need to do is to put on your active 3D glasses.

Read more about 3D in **Help > Basics > Watch 3D**.

The remote control

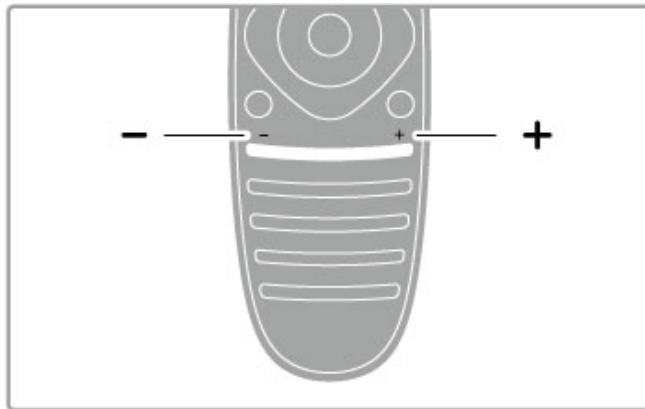

To adjust the volume.

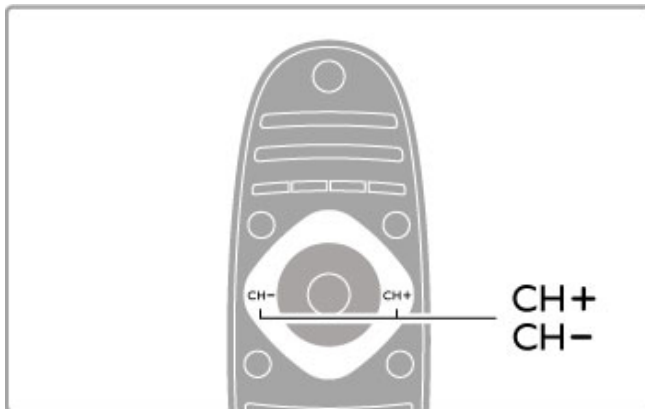

To switch TV channels.

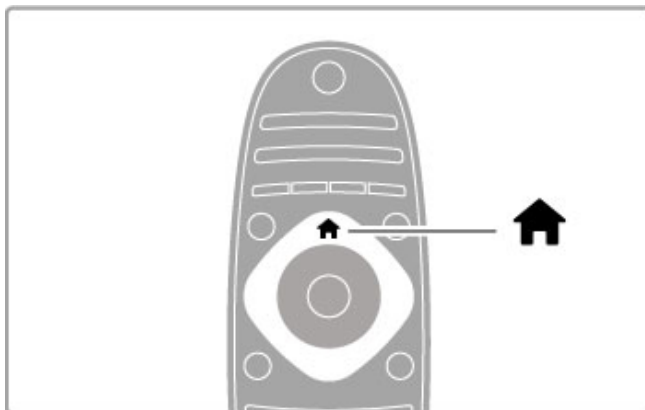

To open or close the **Home menu** .

Open the Home menu as a starting point to operate the TV.

In the Home menu, you can start or stop a TV activity, such as watching TV - **Watch TV** - or watching a movie from a connected DVD player.

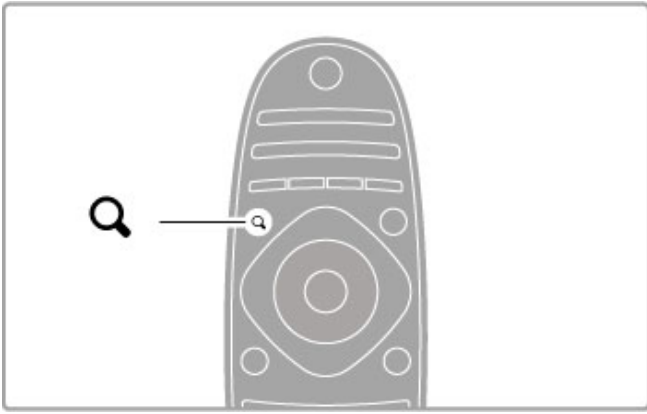

To open or close the **FIND** menu **Q**.

Open the Find menu to open the **list of channels** while you are watching TV channels or the list of videos and music while you browse your PC on TV.

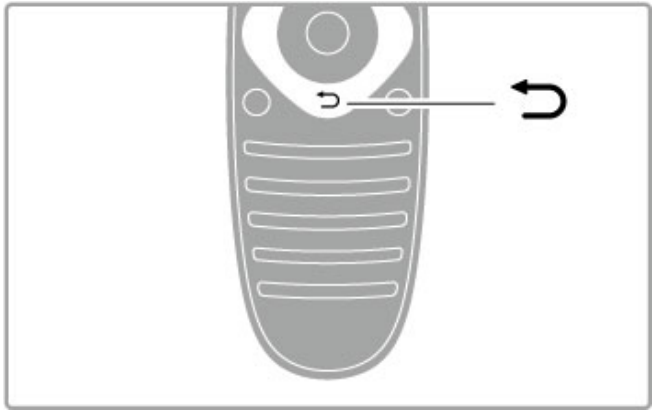

Back ↶.

With Back, you can go back to the previous TV channel or go one step back in a menu.

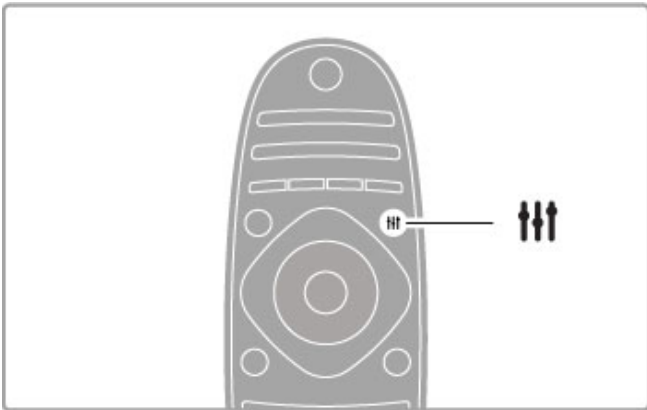

To open or close the **ADJUST** menu **≡**

Open the Adjust menu to quickly adjust the picture and sound settings.

You can set the Smart picture setting to **Game**, which is ideal for gaming, or change the Smart sound setting of the TV loudspeakers.

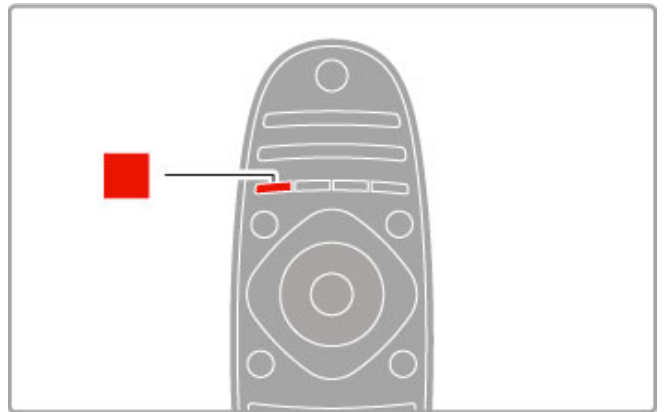

Red

With the red key, you can select the red option or open digital **Interactive TV** or some TV demonstration clips.

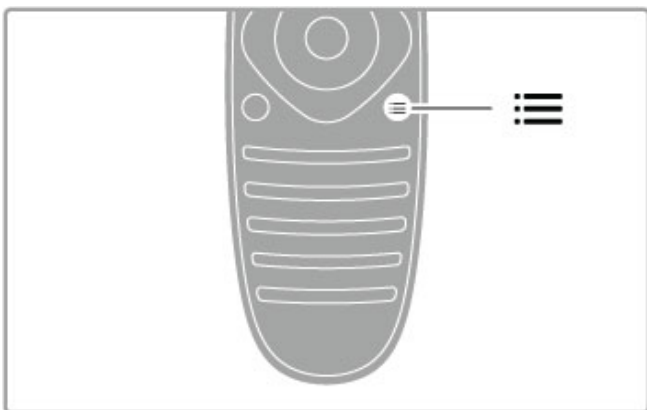

To open or close the **OPTIONS** menu **≡**.

Open the Options menu to select optional settings related to what you are watching or doing on TV.

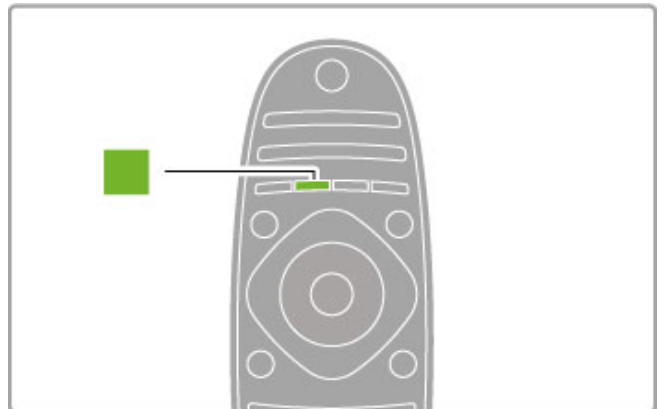

Green

With the green key, you can select the green option or the **Eco settings**.

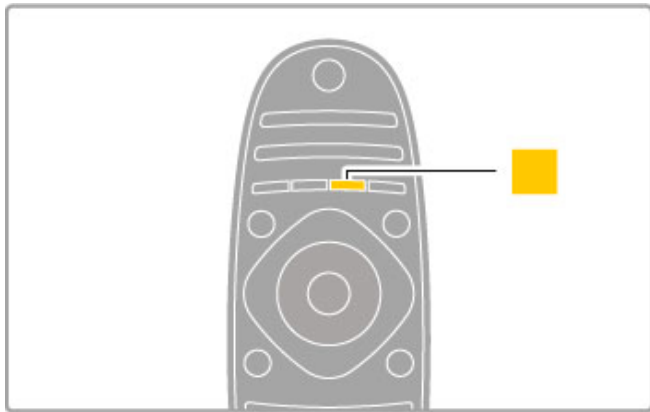

Read more about Add your devices in [Help > Basics > Menus > Home](#).

Read more about using EasyLink in [Help > Basics > Remote control > Operate devices](#).

In the chapter [Help > Connections](#), drawings like these will help you to connect most common devices.

Yellow

With the yellow key, you can select the yellow option.

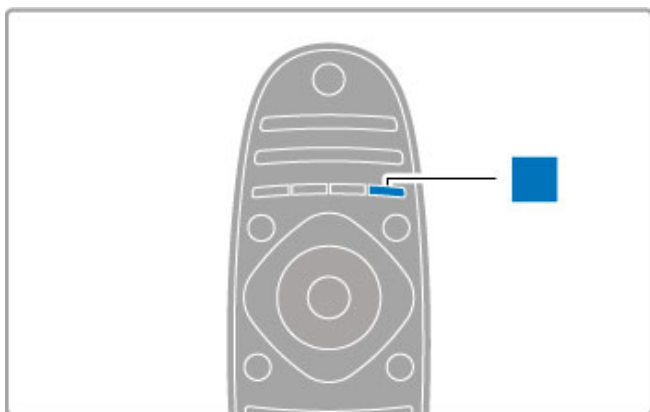

Blue

With the blue key, you can select the blue option.

Read more about the remote control in [Help > Basics > Remote control > Overview](#).

Or go to the [Q Search](#) page in this Help to look for any topic.

Press **▲** to select the next TV tour.

Connecting devices

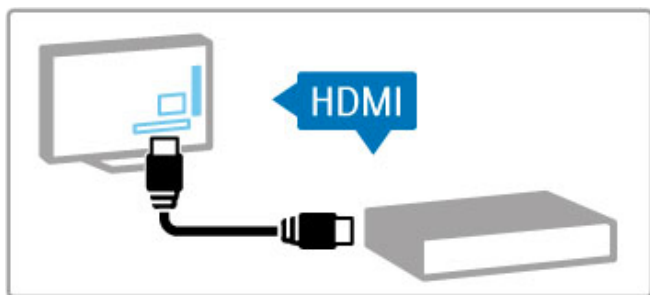

Use the **HDMI™** connection to connect a DVD, Blu-ray Disc player or game console.

The HDMI connection offers the best picture and sound quality and, if your device has **EasyLink** (HDMI-CEC), the TV can add the device to the Home menu automatically.

When a device is added to the Home menu, you can select it to watch its programme. If the device has no EasyLink or you do not use the HDMI connection, you must add the connected device in the Home menu using **Add your devices**.

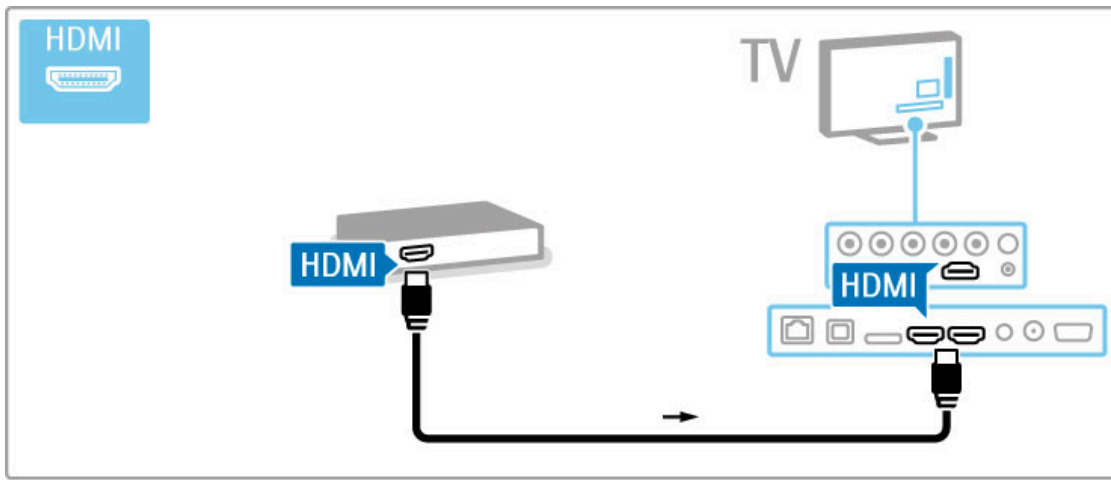

HD TV

This TV can display High Definition programmes, but to enjoy HD TV you need to get programmes in HD first. If you are not watching HD programmes, the picture quality will be that of a normal TV.

Watch **HD TV** programmes from . . .

- a Blu-ray Disc player
- a digital HD receiver connected with HDMI and with a subscription to HD programmes
- over-the-air HD broadcasts
- channels offering HD on a digital network
- an HD game console connected with HDMI and playing an HD game

HD video clip

To experience the stunning sharpness and picture quality of HD TV, you can start the High Definition video clip from the Home menu. Press **Home** > **Setup** > **Watch demos** (on the second page of the Setup menu).

Contact your dealer for more information.

Go to www.philips.com/support to find FAQs featuring the list of HD channels or providers in your country.

1.2 Setting up

Stand or wall mounting

The foot of the TV stand has the TV loudspeakers built-in. Always connect the cable of the foot to the TV for sound. For best sound, place the TV on a hard surface.

Wall mounting

With the foot and neck of the TV stand, you can mount the TV to the wall. Combine the foot and neck to make a swivel mount or alternatively use only the foot to mount the TV close to the wall.

Find all mounting instructions in the Quick Start Guide that came with the TV. In case you lost this guide, you can download the guide from www.philips.com

Use the product type number of the TV to look for the Quick Start Guide to download.

Caution

Wall mounting the TV requires special skills and should only be performed by qualified personnel. The TV wall mounting should meet safety standards according to the TV's weight. Read also the safety precautions before positioning the TV.

TP Vision Netherlands B.V. bears no responsibility for improper mounting or any mounting that results in accident or injury.

VESA info

Your TV is prepared for a VESA-compliant wall mount bracket (sold separately). Find the suitable VESA code next to the TV type number.

52PFL9606 - VESA MIS-F 300,300,M6

46PFL9706 - VESA MIS-F 300,300,M6

46PFL8686 - VESA MIS-F 400,400,M6

46PFL8606 - VESA MIS-F 400,400,M6

40PFL8606 - VESA MIS-F 400,400,M6

37PFL9606 - VESA MIS-F 200,200,M6

32PFL9606 - VESA MIS-F 200,100,M6

Use a screw length as shown in the drawing.

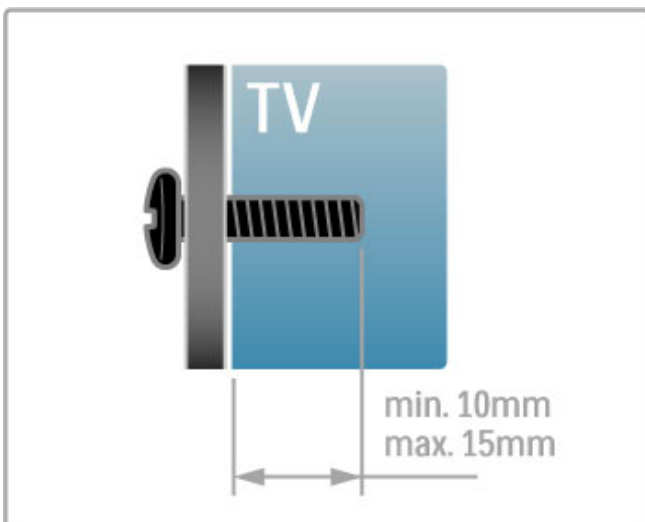

Position the TV

Carefully read the safety precautions before you position the TV.

- Position the TV where light does not shine directly on the screen.
- Dim lighting conditions in the room for best Ambilight effect.
- Position the TV up to 25 cm away from the wall for the best Ambilight effect.

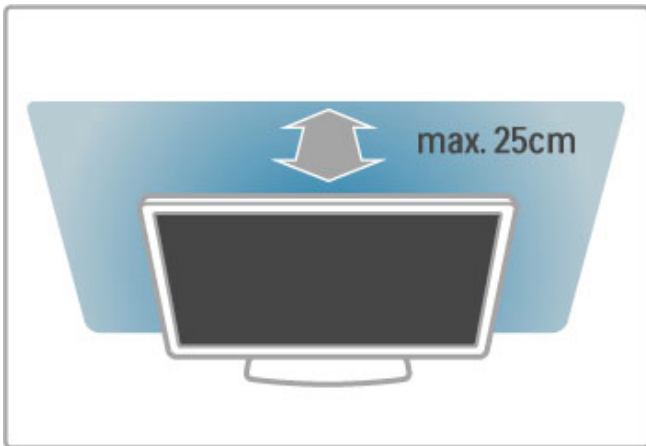

Position the TV at the ideal viewing distance. Get more from HD TV picture or any picture without straining your eyes. Find the 'sweet spot', right in front of the TV, for the best possible TV experience and relaxed viewing.

The ideal distance to watch TV from is three times its diagonal screen size. When seated, your eyes should be level with the centre of the screen.

For best sound, place the TV on a hard surface.

Safety

Read and understand all instructions before you use the TV. If damage is caused by failure to follow instructions, the warranty does not apply.

Risk of electric shock or fire!

- Never expose the TV to rain or water. Never place liquid containers, such as vases, near the TV. If liquids are spilt on or into the TV, disconnect the TV from the power outlet immediately. Contact Consumer Care to have the TV checked before use.
- Never expose the TV, remote control or batteries to excessive heat. Never place them near burning candles, naked flames or other heat sources, including direct sunlight.
- Never insert objects into the ventilation slots or other openings on the TV.
- Never place heavy objects on the power cord.
- Avoid force coming onto power plugs. Loose power plugs can cause arcing or fire. Ensure that no strain is exerted on the power cord when you swivel the TV screen.
- To disconnect the TV from the mains power, the power plug of the TV must be disconnected. When disconnecting the power, always pull the power plug, never the cord. Ensure that you have full access to the power plug, power cord and outlet socket at all times.

Risk of injury or damage to the TV!

- Two people are required to lift and carry a TV that weighs more than 25 kg or 55 lbs.
- If you mount the TV on a stand, only use the supplied stand. Secure the stand to the TV tightly. Place the TV on a flat, level surface that can support the weight of the TV and the stand.

- When wall mounted, ensure that the wall mount can safely bear the weight of the TV set. TP Vision Netherlands B.V. bears no responsibility for improper wall mounting that results in accident, injury or damage.
- Parts of this product are made of glass. Handle with care to avoid injury or damage.

Risk of damage to the TV!

Before you connect the TV to the power outlet, ensure that the power voltage matches the value printed on the back of the TV. Never connect the TV to the power outlet if the voltage is different.

Risk of injury to children!

Follow these precautions to prevent the TV from toppling over and causing injury to children:

- Never place the TV on a surface covered by a cloth or other material that can be pulled away.
- Ensure that no part of the TV hangs over the edge of the mounting surface.
- Never place the TV on tall furniture, such as a bookcase, without anchoring both the furniture and TV to the wall or a suitable support.
- Teach children about the dangers of climbing on furniture to reach the TV.

Risk of swallowing batteries!

The remote control may contain coin-type batteries which can easily be swallowed by small children. Keep these batteries out of reach of children at all times.

Risk of overheating!

Never install the TV in a confined space. Always leave a space of at least 10 cm or 4 inches around the TV for ventilation. Ensure curtains or other objects never cover the ventilation slots on the TV.

Lightning storms

Disconnect the TV from the power outlet and antenna before lightning storms. During lightning storms, never touch any part of the TV, power cord or antenna cable.

Risk of hearing damage!

Avoid using earphones or headphones at high volumes or for prolonged periods of time.

Low temperatures

If the TV is transported in temperatures below 5°C or 41°F, unpack the TV and wait until the TV temperature reaches room temperature before connecting the TV to the power outlet.

Care

- Never touch, push, rub or strike the screen with any object.
- Unplug the TV before cleaning.
- Clean the TV and frame with a soft damp cloth. Never use substances such as alcohol, chemicals or household cleaners on the TV.
- To avoid deformations and colour fading, wipe off water drops as quickly as possible.
- Avoid stationary images as much as possible. Stationary images are images that remain onscreen for extended periods of time. Stationary images include onscreen menus, black bars, time displays, etc. If you must use stationary images, reduce screen contrast and brightness to avoid screen damage.

Temperature and humidity

In rare occasions, depending on temperature and humidity, minor condensation can occur on the inside of the TV glass front (on some models). To prevent this, do not expose the TV to direct sunlight, heat or extreme humidity. If condensation occurs, it will disappear spontaneously while the TV is playing for a few hours. The condensation moisture will not harm the TV or cause malfunction.



1.3 Keys on the TV

Power switch

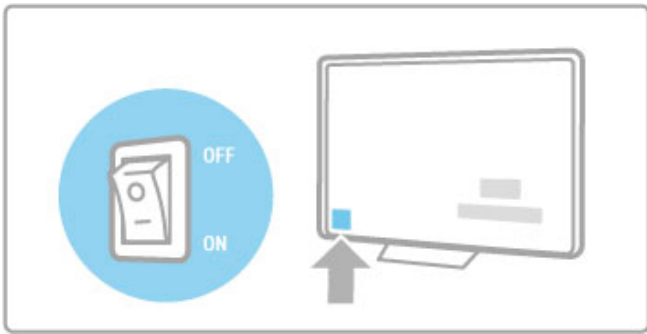
Switch the TV on or off with the power switch at the right-hand side of the TV. When switched off, the TV does not consume any energy.



If the red indicator light is off, switch on the TV with the power switch.

If the red indicator is on (standby indication), press  on the remote control to switch on the TV. Alternatively, you can switch on the TV from standby with **CH+**, **CH-** or . It takes a few seconds for the TV to start up.

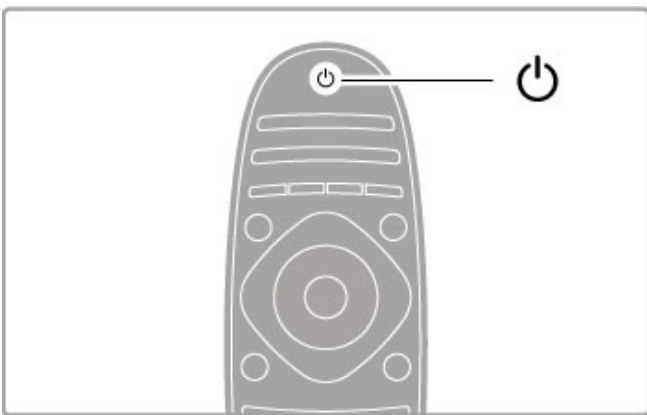

Volume

Press  (Volume) - or **+** to adjust the volume. Or use the **+** or **-** keys on the remote control.

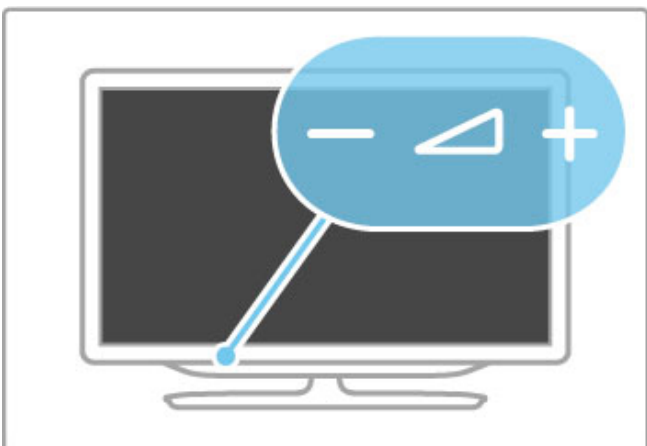



Ambilight

Press **Ambilight**, to switch Ambilight on or off.

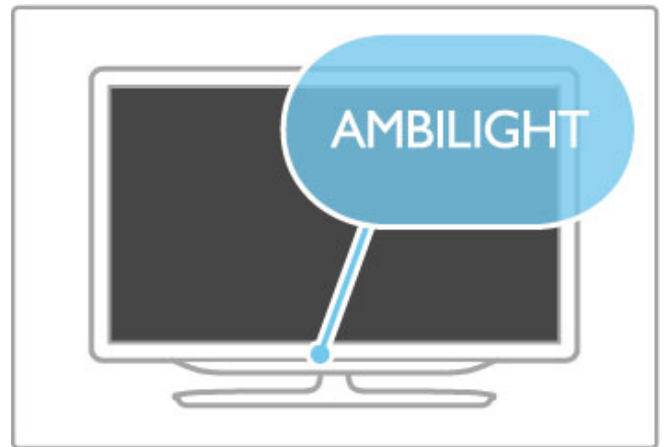
While the TV is on standby, you can switch Ambilight on and create an Ambilight Lounge light effect in your room. Read more about Ambilight and Lounge light in [Help > Setup > Ambilight](#)





Home

Press  (Home) to open the Home menu on screen. You can navigate the Home menu with the volume - or **+** (left or right) and the channel - or **+** (down or up) keys on the TV. To confirm your choice, press  again.

Read more about Home in [Help > Basics > Menus > !\[\]\(235bfe13ebf007ce2eea9e689707fac7_img.jpg\) Home](#)



CH Channel

Press **CH** (Channel) - or **+** to switch channels. Or use the  or  keys on the remote control.

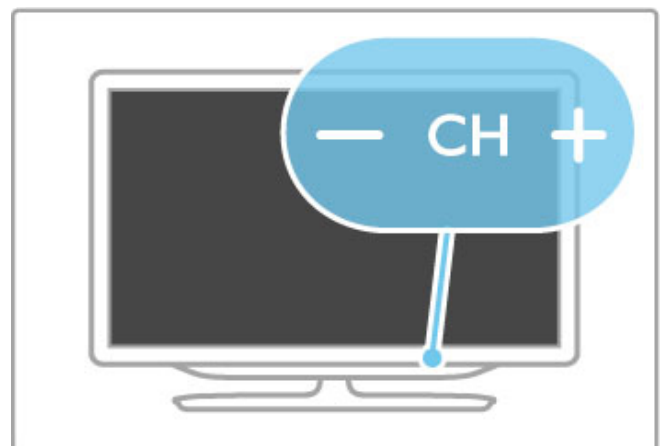

1.4 Register your TV

Congratulations on your purchase and welcome to Philips.

Register your TV and enjoy a range of benefits including full support (including downloads), privileged access to information about new products, exclusive offers and discounts, the chance to win prizes and even participate in special surveys about new releases.

Go to www.philips.com/welcome

1.5 Help and support

Using Help and Search

Help

You can open Help from the Home menu. In most cases, you can also press the **yellow** key on your remote control to open or close Help directly. For some activities, like Text, the colour keys have specific functions and cannot open Help.

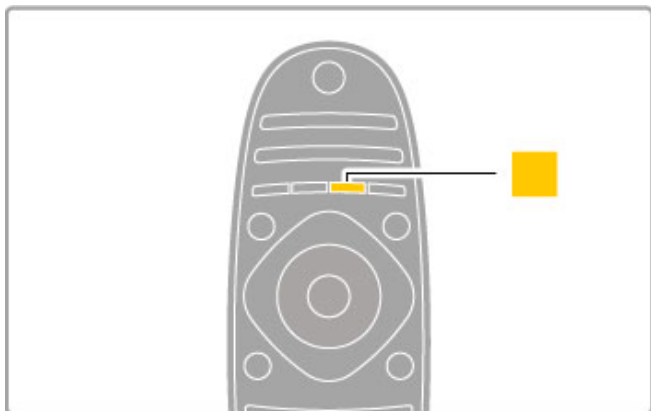

Before you follow the Help instructions, close Help. Press the **yellow** key or press **⬆** to close Help. When you press the **yellow** key again, Help will open on the page where you closed it.

🔍 Search

In Help, use **🔍 Search** to find a topic you need. Select a topic from the list with the navigation keys and press **OK**. The topic you are looking for might not be on the first page but a few pages further on. Press **▶** to go to the next page.

Online support

To solve any Philips TV related problem, you can consult our online support. You can select your language and enter your product model number.

Go to www.philips.com/support

On the support site you can find your country's telephone number to contact us as well as answers to frequently asked questions (FAQs).

You can download new TV software or the manual to read on your PC. You can email a specific question or, in some countries, chat online to one of our collaborators.

Consumer Care

For support, you can call the Consumer Care hotline in your country. Find the telephone number in the printed documentation that came with the TV.

Or consult our website www.philips.com/support

TV model number and serial number

You might be asked to provide the TV product model number and serial number. Find these numbers on the packaging label or on the type label on the back or bottom of the TV.

2 Basics

2.1 Remote control

Overview

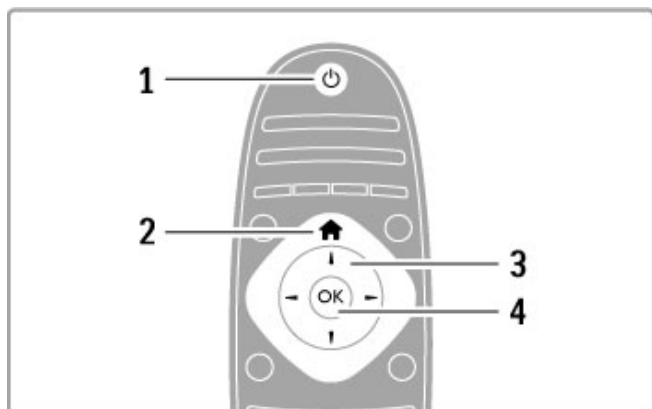

1 Standby

To switch the TV on or back to standby.

2 Home

To open or close the Home menu.

3 Navigation key

To navigate up, down, left or right.

4 OK key

To activate a selection.

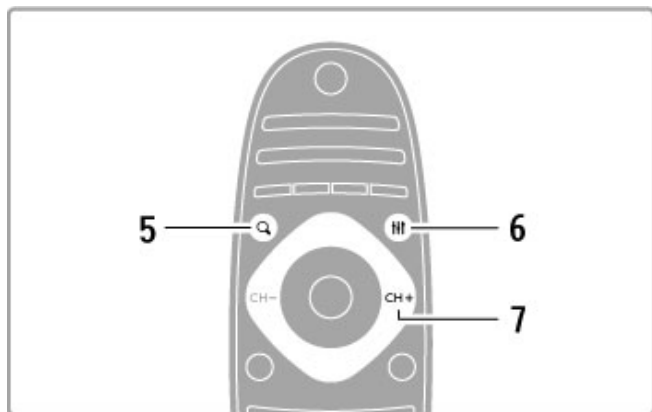

5 Find

To open or close the channel list or your list of photos, music or movies.

6 Adjust

To open or close the most used settings for picture, sound, Ambilight or 3D.

7 CH+ / Next

To switch to the next channel, page or chapter.

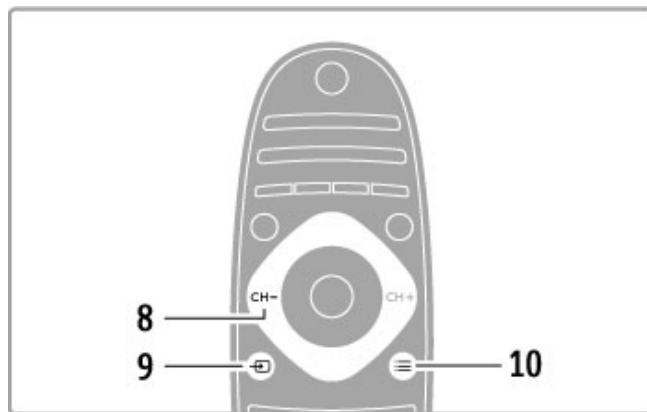

8 CH- / Previous

To switch to the previous channel, page or chapter.

9 Source

To switch directly to a TV connection.

10 Options

To open or close the Options menu.

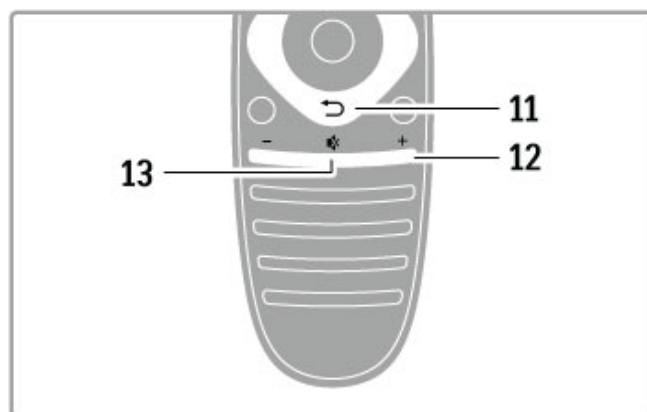

11 Back

To go back to the previous channel. To exit a menu without changing a setting. To go back to the previous Text or Net TV page.

12 Volume

To adjust the volume level.

13 Mute

To mute the sound or to restore it.

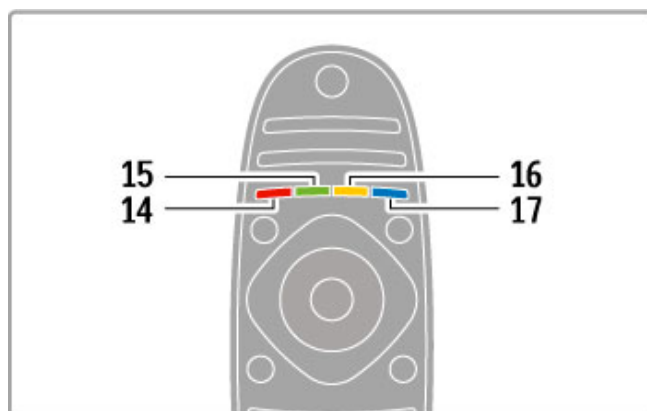

14 Red colour key

To open interactive TV or to select a Text page.

15 Green colour key

To open the Eco settings or to select a Text page.

16 Yellow colour key

To select a Text page.

17 Blue colour key

To select a Text page.

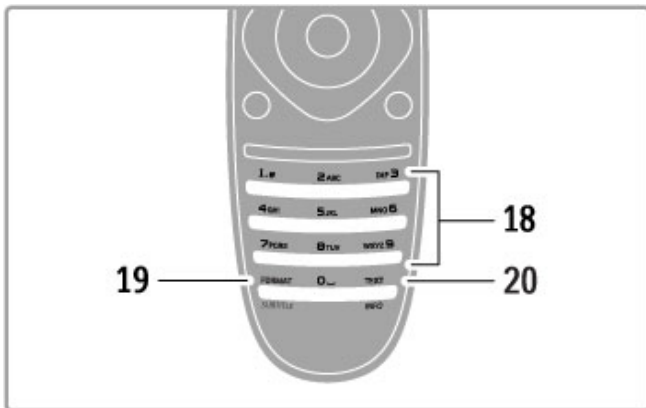

18 Number keys and text keypad

To select a TV channel directly or to enter text.

19 Format / Subtitles

To open or close the Format menu. / Keep this key pressed for 3 seconds to show or hide subtitles.





20 Text / Info

To open or close text. / Keep this key pressed for 3 seconds to open or close information on next programmes.

Operate devices

The remote control of the TV can also operate a connected device. The device must have EasyLink (HDMI-CEC) and have it switched on. The device must also be connected with an HDMI cable.

Operate an EasyLink device

To operate such a device with the TV remote control, select the device -or its activity- in the  Home menu and press **OK**. The commands of all keys, except the  key, the  **ADJUST** key and the  **OPTIONS** key, are forwarded to the device.

Switch back to TV

To switch the remote control back to operate the TV, press  (Home) and select **Watch TV** and press **OK**.

Show device keys

When operating a device, some of the keys might not be available on the TV remote control. To make these keys selectable on TV, press  **OPTIONS** and select **Show device keys**. Select the key you need and press **OK**.

To hide the device keys, press  (Back).

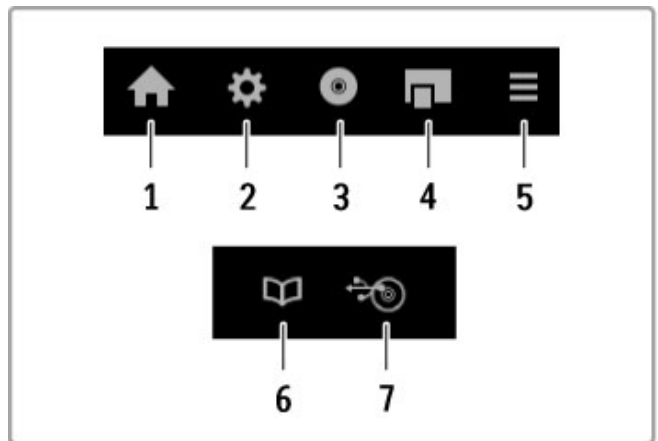

In general, these keys open the following device menus:

- 1 Home menu
- 2 Setup menu
- 3 Disc menu (disc content)
- 4 Pop-up menu
- 5 Options menu
- 6 Programme guide
- 7 Media selection

One Touch Play

Insert a disc into an EasyLink HDMI-CEC device and press **Play** on the device. The TV switches on from standby and starts playing the disc.

System Audio Control

If you connect an EasyLink audio system, you can listen to the audio from the TV through the audio system. The TV speakers are muted automatically. You can control the volume of the audio system with the TV remote control.

Surround mode

With recent Philips devices, you can change the surround sound setting of the device on the TV. To change this setting, press  **ADJUST**, select **Surround mode** and press **OK**. On **Next mode**, press **OK** to toggle through the available modes on the device.

Smart sound

With recent Philips devices, you can change the Smart sound setting of the device on the TV. To change this setting, press  **ADJUST**, select **Smart sound** and press **OK**. Select a sound mode from the list.

Screen off

If a recent Philips audio device only sends audio to the TV, the device may suggest switching off the TV screen. To switch off the screen when this message appears, select **Screen off** and press **OK**. To switch the screen back on, press  (Home).

System Standby

Press  on the remote control to switch the TV and all EasyLink devices to standby.

Read more about EasyLink in **Help > Setup > Devices > EasyLink HDMI-CEC**.

IR sensor

Always make sure you point the remote control at the remote control infrared sensor on the front of the TV.

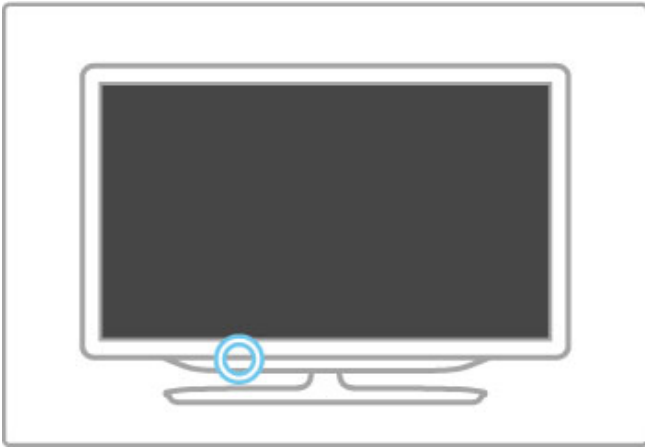

Batteries

To open the battery cover, press the small button on the edge of the remote control inwards and lift the cover. Use 2 type AAA-LR03-1.5V batteries. Make sure the + and the - ends of the batteries line up correctly.

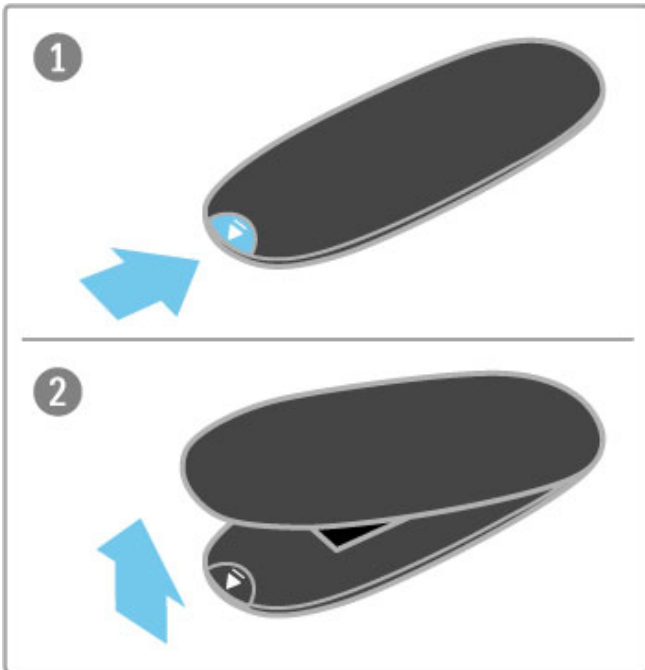

Remove the batteries if you are not using the remote control for a long time.

Dispose of batteries according to the end of use directives. Read [Help > Specifications > Environmental > End of use](#).

Cleaning

Your remote control is treated with a scratch-resistant coating.

To clean the remote control, use a soft damp cloth. Never use substances such as alcohol, chemicals or household cleaners on the TV or remote control.

2.2 Menus

🏠 Home

In the Home menu, you start watching TV or start watching a movie disc or any other TV activity.

Press 🏠 to open the Home menu.

To start an activity, select it with the navigation keys and press **OK**.

To close the Home menu, press 🏠 again.

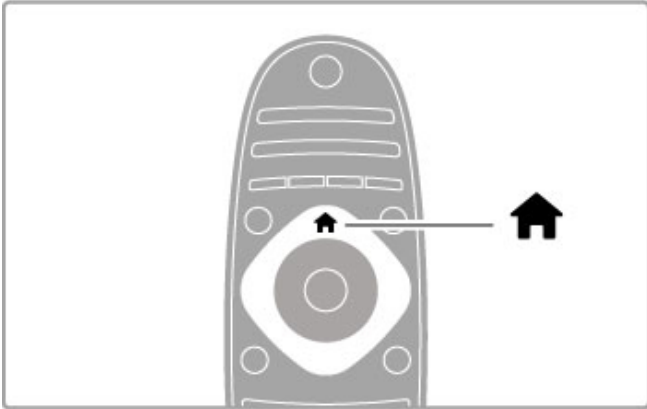

Add your devices

A connected device should be added to the Home menu for easy selection.

If your connected device does not have EasyLink (HDMI-CEC) or is not connected with an HDMI cable, you need to manually add your device to the Home menu with **Add your devices**.

Devices with EasyLink (HDMI-CEC) and connected with an HDMI cable automatically show their activity in the Home menu. A single device can add several activities.

If an EasyLink device does not appear automatically, EasyLink on the device may be switched off.

Add a device manually

In the Home menu, select **Add your devices** and press **OK**. Follow the instructions on screen.

The TV asks you to select the device and the connection to which the device is connected.

The device or its activities are now added to the Home menu.

Rename a device

To rename an added device or activity, select the device in the Home menu and press **≡ OPTIONS** and select **Rename**. Use the keypad on the remote control as you do for SMS/text messaging to enter the new name.

Remove a device

To remove a device or activity from the Home menu, select it and press **≡ OPTIONS** and then select **Remove this device**. If a device or activity keeps appearing in the Home menu after you deleted it, switch off the EasyLink setting on the device to prevent the icon from being automatically added again.

Read more about EasyLink in **Help > Basics > Remote control > Operate devices**.

Reorder

To reorder a device or an activity in the Home menu, select it and press **≡ OPTIONS**.

1 Select **Reorder**.

2 With the navigation keys, reposition the device or activity where you want it. You can only reorder the sequence of the added devices and activities.

3 Press **OK** to confirm the position. All devices and activities shift to the right.

You can highlight another device or activity and reposition it.

To stop Reorder, press **≡ OPTIONS** and select **Exit reorder**.

Restore device activities

To recall a deleted activity from a device with several activities, select the device or one of its activities and press **≡ OPTIONS**. Select **Restore device activities** and press **OK**. All deleted activities of this device appear again.

🔍 FIND

With **🔍 FIND** you open the Channel list while you are watching TV channels or you open the list of pictures, music and videos while browsing your PC or connected USB device.

Press **🔍 FIND** to open the list.

To close the list, press **🔍 FIND** again.

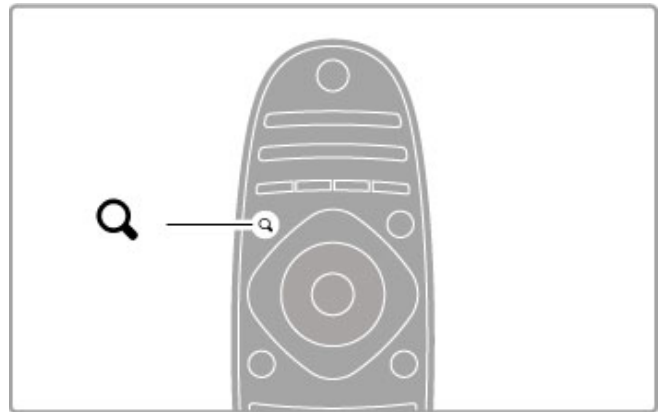

⚙️ ADJUST

With the **ADJUST** menu, you can adjust picture, sound, Ambilight and 3D settings quickly.

Press **⚙️ ADJUST** to open the Adjust menu.

Select your choice with the navigation keys and press **OK**.

To close the menu, press **⚙️ ADJUST** again.

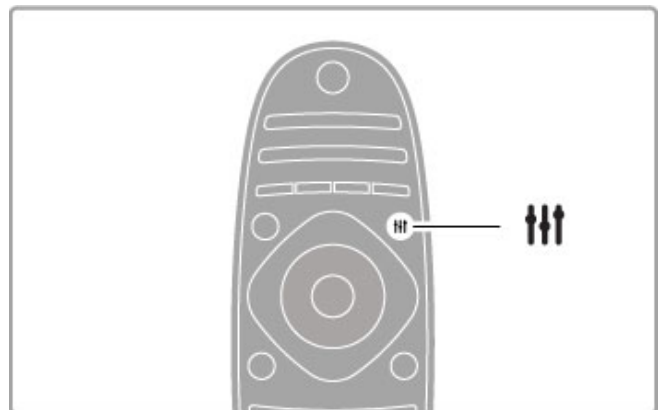

In the Adjust menu you can adjust these settings:

- 3D
- 3D depth
- Two player gaming
- Ambilight On or Off
- Ambilight dynamics
- Picture format
- Smart picture (presets)
- Smart sound (presets)
- Speakers
- Surround
- Picture shift

Ambilight

Read more about the Ambilight settings in **Help > Setup > Ambilight**.

Picture format

Read more about the Picture format settings in **Help > Basics > Watch TV > Picture format**.

Smart picture, Smart sound

You can set the TV to the pre-defined setting that best suits what you're watching.

Read more about Smart settings in **Help > Basics > Watch TV > Smart picture and sound**.

Speakers

To hear the sound through the TV speakers, close Help, press **⏏ ADJUST**, select **Speakers** and select **TV**.

Select **Amplifier** if you want to hear the sound through a connected Home Theatre System or Amplifier.

These settings temporarily override any EasyLink settings.

Surround

To switch the TV automatically to the best surround sound mode (only available when a Home Theatre System is connected), close Help, press **⏏ ADJUST**, select **Surround** and select **On**.

Picture shift

You can shift the picture on screen in a vertical or a horizontal direction to view subtitles fully (depending on the TV input).

While watching TV, press **⏏ ADJUST**, select **Picture shift** and press **OK**. Shift the picture with the navigation keys. Press **OK** to stop Picture shift.

☰ OPTIONS

With the OPTIONS menu, you select optional settings related to what you are watching or doing on TV.

Press **☰ OPTIONS** at any time to see which options are available.

To close the menu, press **☰ OPTIONS** again.

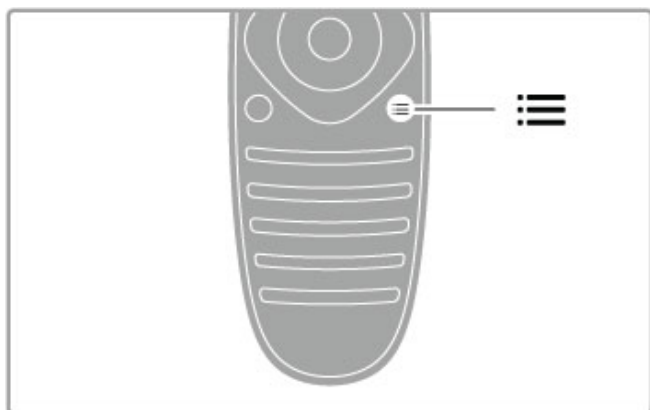

2.3 Watch TV

Switch channels

To watch TV and switch channels, make sure the **Watch TV** option is selected in the Home menu.

To watch TV, press **⬆️**, select **Watch TV** and press **OK**.



To switch channels, press **CH+** or **CH-** on the remote control. You can use the number keys if you know the channel number or press **Q FIND** to open the Channel list to select a channel.

To switch back to the previous channel, press **⏪** (Back).

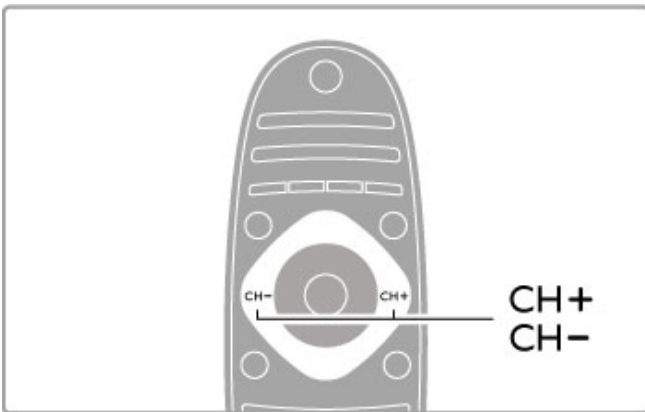

Radio channels

If digital broadcasting is available, digital radio stations are installed during installation. Switch to a radio channel just like you switch to a TV channel. A DVB-C channel installation usually places radio stations from channel number 1001 onwards.

Options for watching TV channels

If you watch digital broadcast TV channels, press **≡ OPTIONS** to view the available options:

- What's on
- Status
- Video selection

What's on

This option shows information on the current and next programme on this channel. Use the navigation keys to scroll through text or to go to the next column.

Status

Depending on the broadcast, the Status page will show relevant information. You can use this information to improve the channel signal or to check if certain services are available.

Video selection

Digital TV channels can offer multi video signals (multi-feed broadcasts), different camera viewpoints or angles of the same event or different programmes on one TV channel. The TV shows a message to advise if any such TV channels are available. When available, press **≡ OPTIONS** and select **Video selection** to select your choice.

Channel list

In the Channel list, you can look up all installed TV and radio channels.

While watching TV, press **Q FIND** to open the Channel list. Press **Q FIND** again or **⏪** (Back) to close the Channel list without changing the channel.

In the Channel list, you can navigate to a TV channel or radio station and press **OK** to watch the TV channel or listen to the radio station.

The Channel list can have several pages. To view the next or previous Channel list page, press **▶** or **◀**.

Channel list options

With the Channel list on screen, press **≡ OPTIONS** to select the following options:

- Select list
- Mark as favourite
- Reorder
- Rename

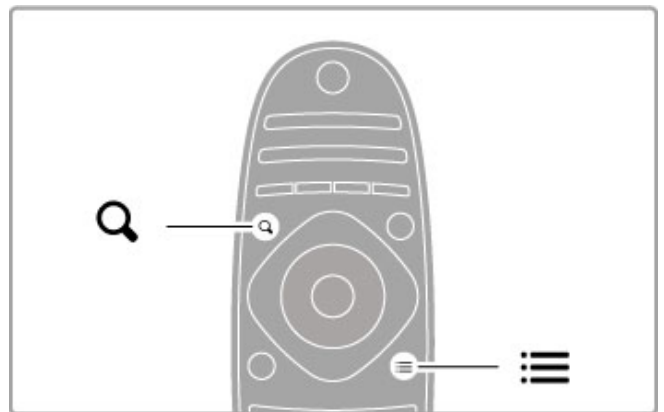

Select list

Use this option to select which channels are shown in the Channel list. The list you select here determines which channels you flick through with **CH+** and **CH-**.

Mark as favourite

When a channel is highlighted in the Channel list, you can set it as a favourite channel.

Read **Basics > Watch TV > Favourite channels**.

Reorder

You can reposition channels within the list.

1 Press **≡ OPTIONS** and select **Reorder** to start reordering channels.

2 Highlight a channel and press **OK**.

3 Reposition the channel where you want it with the navigation keys. Alternatively, enter the new position directly with the number keys.

4 Press **OK** to confirm the position. You can insert the channel or swap it.
You can highlight another channel and do the same.

To stop Reorder, press **≡ OPTIONS** and select **Exit reorder**.

Rename

You can rename a channel in the Channel list.

- 1 In the channel list, highlight the channel you want to rename.
- 2 Press **≡ OPTIONS** and select **Rename** to start renaming. You can enter text directly with the remote control keypad or open a full keyboard on top of the text entry menu.



Enter text with the remote control keypad

Use the navigation keys to position the cursor in the text. Press **↶** (Back) to delete a character.

Use the remote control keypad as you do for SMS/text messaging to enter a character. Use the **1** key to select a special character. Select **Clear** to delete a character.

Select **Done** to end Rename.

Enter text with the on-screen keyboard

To open the on-screen keyboard on top of the text entry menu, press **OK** when the cursor in the text flashes.

On the keyboard, use the navigation keys to highlight a character and press **OK** to enter it. To delete a character, press **↶** (Back) or highlight **✕** and press **OK**.

To switch from uppercase to lowercase or to a set of special characters, press **▶** (Next) or **◀** (Previous).

To edit a character within a line of text, position the cursor on this character and use the **←** and **→** keys at both ends of the on-screen spacebar.

To close the on-screen keyboard, highlight **Done** and press **OK**.

USB keyboard

You can use a connected USB keyboard to rename channels. To connect a USB keyboard, read **Help > Connections > Connect more devices > Keyboard and mouse**.

Favourite channels

In the Channel list you can mark a channel as a favourite. You can set the Channel list to only zap through your list of favourite channels.

To open the **Channel list**, while you are watching TV channels, press **Q FIND**.

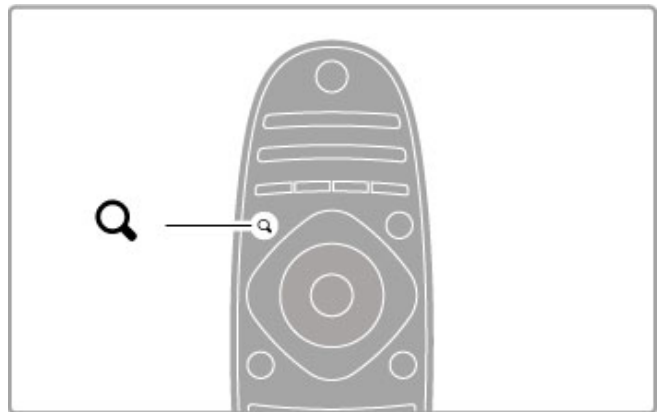

Mark a channel as favourite

While watching TV, press **Q FIND** to open the Channel list. Navigate to the channel you want to mark as favourite and press **≡ OPTIONS**. Select **Mark as favourite**.

In the Channel list, the favourite channel is marked with a **★**. You can unmark a favourite channel with **Unmark favourite**.

Channel list of favourites

You can set the Channel list to only flick through your favourite channels.

With the list on screen, press **≡ OPTIONS** and select **Select list**. Select **Favourites** from the list and press **OK**. With this list selected, you will only flick through your favourites.

Programme guide

If programme guide information is available in your area, you can open an on-screen programme guide with scheduled TV programmes.

The Programme guide is provided by the broadcaster or Internet.

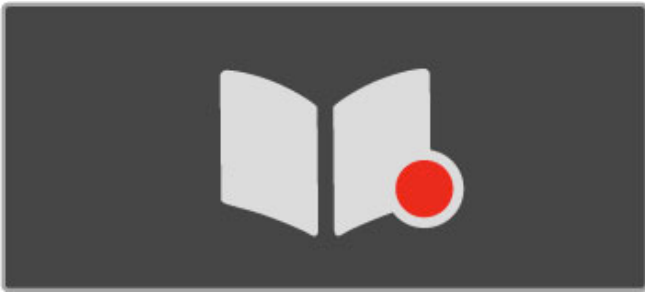

Open the Programme guide

While watching TV, press **⬆**, select **Programme guide** and press **OK**.

To quit the Programme guide without changing a setting, press **⬅** (Back).

First use

The first time you open the Programme guide, the TV scans all TV channels for programme guide information. This can take several minutes. The data is stored in the TV. The TV can store programme data for up to eight days.

Programme guide options

With a programme selected in the guide, press **☰** **OPTIONS** to select the following:

- **Set reminder**

To set an on-screen reminder for when a programme is due to start, select **Set reminder** and press **OK**. The programme is marked with a **🕒** (Clock). To cancel this reminder, select **Clear reminder** and press **OK**.

- **Change day**

View the previous or next day's programmes.

- **More info**

Shows the programme details and summary.

- **Search by genre**

View all programmes selected by genre.

- **Scheduled reminders**

If a reminder is set, you can view a list of all scheduled reminders.

- **Update programme guide**

After the first scan, the TV stores the programme guide data. If you update or reinstall channels or reorder the Channel list, you will need to update the Programme guide.

To update, select **Update programme guide**. Reminders are cleared.

Broadcaster or Network

To select where the Programme guide information comes from, press **⬆** > **Setup** > **TV settings** > **Preferences** > **Programme guide**.

Select **From the network** or **From the broadcaster**.

From the network

Until you link up with Net TV, programme guide information comes from the broadcaster. Once you are connected with Net TV, the TV switches automatically to the Internet for programme guide information.

From the broadcaster

Guide information comes from the broadcaster/operator.

For easy picture or sound adjustment, you can select a preset setting for each.

While watching TV, press **≡** **ADJUST** to open the Adjust menu and select **Smart picture** or **Smart sound**. Make a selection from the list and press **OK**.

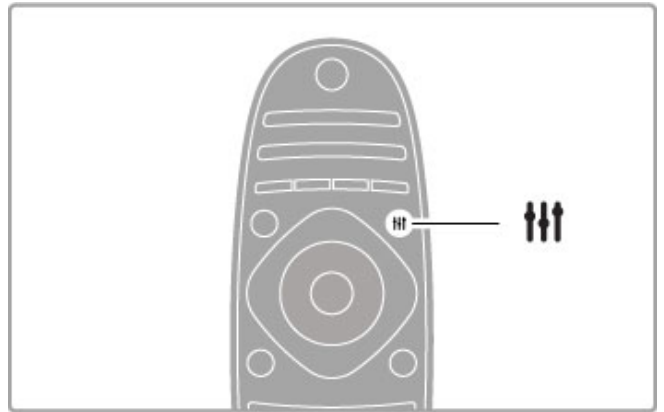

Smart picture and Smart sound

Smart settings are a combination of preset settings suited to a specific use such as gaming or daylight viewing.

You can adjust a specific setting, like Brightness or Contrast, Bass or Treble, of a chosen smart setting. The smart setting will remember the adjustments you made.

Adjust smart settings

To adjust a specific setting of a smart setting, select the smart setting and press **OK**. Then press **⬆** and select **Setup**. Select **TV settings**, navigate to the individual setting and adjust it.

To return to the original smart setting values, undo the adjustments you made by first setting the TV in the smart setting you want to reset. Then press **⬆** > **Setup** > **TV settings**, select **Reset** and press **OK**.

Read more about adjusting separate settings in **Help** > **Setup** > **Picture and Sound** and **Ambilight**.

Smart picture list

- **Personal** - Your choices made in Personalise picture and sound
- **Vivid** - Ideal for daylight viewing
- **Natural** - Natural picture settings
- **Cinema** - Ideal for watching movies
- **Game** - Ideal for gaming
- **Energy saving** - Energy-conscious settings

- **Standard** - Factory standard settings

- **Photo** - Ideal for viewing photos

- **ISF Day** and **ISF Night** - ISF Calibration settings

Smart sound list

- **Personal** - Your personal choices made in Personalise picture and sound

- **Standard** - Factory standard

- **News** - Ideal for speech

- **Movie** - Ideal for watching movies

- **Game** - Ideal for gaming

- **Drama** - Ideal for TV soaps

- **Sports** - Ideal for sports programmes

Picture format

Smart picture and sound settings

If black bars appear on the screen, you can adjust the picture format to a format that fills the screen.

While watching TV, press **ADJUST** to open the Adjust menu and select **Picture format**. Select a format from the list and press **OK**.

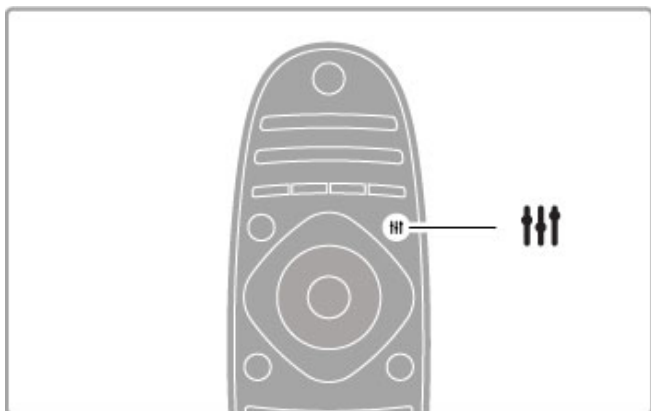

Picture formats

The following formats are available according to the picture on screen:

- **Auto fill**

Automatically enlarges the picture to fill the screen. Minimal picture distortion, subtitles remain visible. Not suitable for PC input.

- **Auto zoom**

Automatically zooms the picture in to fill the screen as much as possible without distortion. Black bars may be visible. Not suitable for PC input.

- **Super zoom**

Removes the black bars on the side of 4:3 broadcasts. The picture is adjusted to fit the screen.

- **Movie expand 16:9**

Scales the picture to a 16:9 format.

- **Wide screen**

Stretches the picture to a 16:9 format.

- **Unscaled**

Expert mode for HD or PC input. Pixel for pixel display. Black bars may appear with pictures from a PC.

Switch to standby

If the TV is on, press **⏻** on the remote control to switch to standby. The red standby key indicator is on. Although the TV consumes very little power when on standby, energy does continue to be consumed.

When you do not use the TV for an extended period of time, switch the TV off completely with the power switch.

Auto switch off

If you use the TV as a monitor or use a digital receiver to watch TV (a set top box - STB) and you do not use the remote control of the TV, switch off the automatic switch off.

This will prevent the TV from switching off automatically after a 4-hour period without a key press on the remote control of the TV.

To switch off the automatic switch off, press the **green** key while you are watching TV channels and select **Auto switch off** and select **Off**.

2.4 3D

What you need

This is a 3D Max TV. To watch 3D on this TV, you will need the Philips 3D Max active glasses PTA516 (sold separately). Other active 3D glasses might not be supported.

To ensure the IR reception of the glasses, clear objects away from the 3D transmitter on the TV.

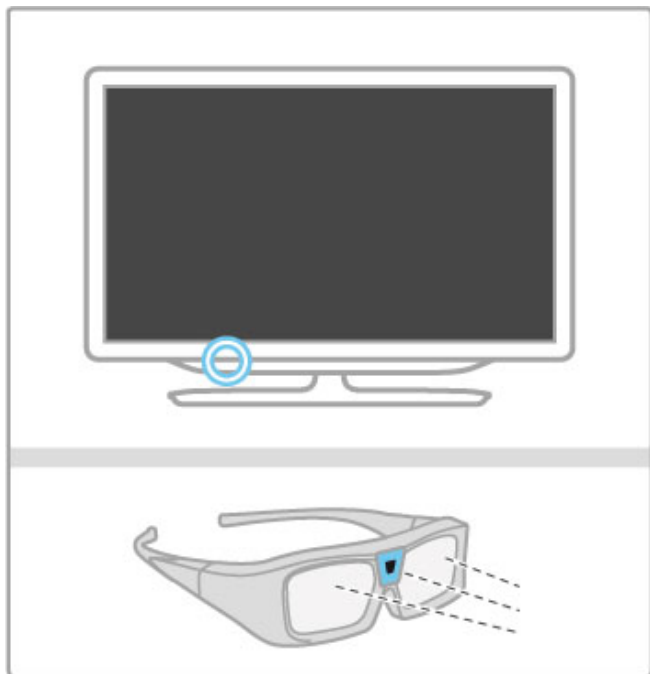

Watch 3D

To start watching a 3D movie or programme, insert a 3D movie into a 3D Blu-ray Disc player or tune to a TV channel that broadcasts programmes in 3D.

Press **Home** (Home) and select the **3D Blu-ray Disc player** or select **Watch TV** and tune to the TV channel.

Start 3D

The TV can detect when 3D is available. When the 3D message appears, select **Start 3D** and press **OK**. Put on the 3D glasses. If the TV cannot detect the 3D signal (the 3D signal tag is missing), the 3D programme is shown as a double image on screen.

To switch the double image to 3D, press **ADJUST**, select **3D** and select **Side by side** or **Top / bottom** according to the double image positions.

You might need to select the inverted format if the normal format results in strange 3D effects.

Stop 3D

To stop watching 3D, press **ADJUST** and select **2D** in the **3D** menu.

You can also stop 3D when you switch to another channel or connected device.

2D to 3D conversion

You can convert any 2D programme to watch it in 3D.

To convert a 2D programme to 3D, press **ADJUST**, select **3D** and select **2D to 3D conversion**.

To stop the 2D to 3D conversion, select **2D** in the 3D menu or switch to another activity in the Home menu. The conversion will not stop if you switch between TV channels.

3D depth

You can change the depth of 3D for a weaker or stronger 3D effect.

To set the 3D depth, press **ADJUST** and select **3D depth**. Use the slider bar to set the 3D depth and press **OK**.

Specifics

- If a 3D TV broadcast is switched to 2D, the TV shows only the 3D-left picture.
- 3D is not available in Multi view

Optimal 3D viewing

For an optimal 3D viewing experience, we recommend that you:

- sit at least 3 times the height of the TV screen away from the TV, but no further than 6 metres away.
- avoid fluorescent lighting (such as TL lighting or certain energy saving light bulbs which operate on a low frequency) and direct sunlight as they may interfere with the 3D experience.

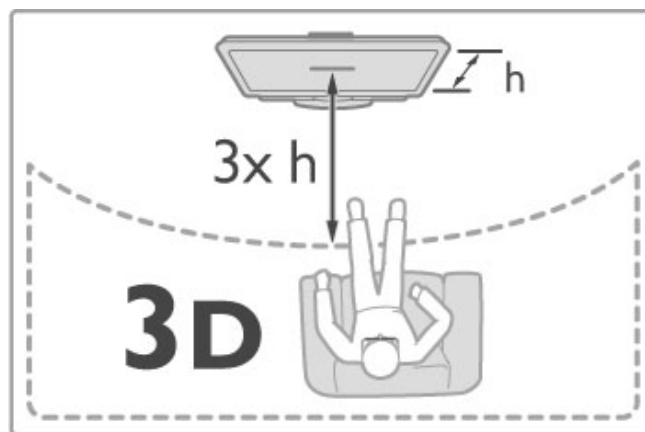

Health warning

- If you or your family has a history of epilepsy or photosensitive seizures, consult a medical professional before exposing yourself to flashing light sources, rapid image sequences or 3D viewing.
- To avoid discomfort such as dizziness, headache or disorientation, we recommend not watching 3D for extended periods of time.

If you experience any discomfort, stop watching 3D and do not immediately engage in any potentially hazardous activity (for example driving a car) until your symptoms have disappeared. If symptoms persist, do not resume watching 3D without consulting a medical professional first.

- Parents should monitor their children during 3D viewing and ensure they do not experience any discomfort as mentioned above. Watching 3D is not recommended for children under 6 years of age as their visual system is not fully developed yet.

- Do not use the 3D glasses for any purpose other than watching 3D TV.
- **CHOKING HAZARD** - Do not let children under 6 years of age play with the 3D glasses, they could choke on the battery lid or battery (if present).

Cleaning and care

- Do not expose the 3D glasses to direct sunlight, heat, fire or water. This may result in a product malfunction or fire.
- Use a clean soft cloth (microfibre or cotton flannel) to clean the lenses to avoid scratching them. Never spray cleaner directly onto the 3D glasses. This may damage the electronics.

- Do not drop, bend or apply force to the lenses of the 3D glasses.
- Do not use cleaning chemicals containing alcohol, solvent, surfactant, or wax, benzene, thinner, mosquito repellent or lubricant. Using these chemicals can cause discoloration or cracks.

2.5 Connected devices

Select a device

Select from the Home menu

To select and watch a connected device or activity, press **Home** to open the **Home menu** and select the device or its activity and press **OK**. Make sure the device is switched on.

Add a connected device to the Home menu for easy selection.

Read more about Add your devices in **Help > Basics > Menus > Home menu**.

Select from the list of connections

To open the list of connections, press **SOURCE**. Select the TV connection and press **OK** to switch to the device on that connection. Make sure the device is switched on.

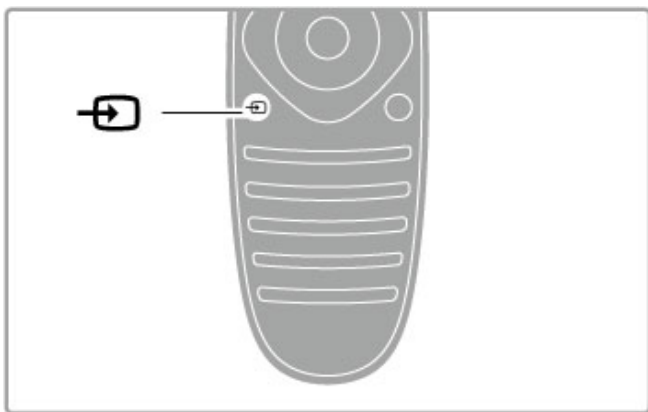

Operate devices

The remote control of the TV can also operate a connected device. The device must have EasyLink (HDMI-CEC) and have it switched on. The device must also be connected with an HDMI cable.

Operate an EasyLink device

To operate such a device with the TV remote control, select the device -or its activity- in the **Home** menu and press **OK**.

The commands of all keys, except the **Home** key, the **ADJUST** key and the **OPTIONS** key, are forwarded to the device.

If the key you need is not on the TV remote control, you can show extra keys on screen with Show device keys.

Show device keys

To show the device keys on screen, press **OPTIONS** and select **Show device keys**. Select the key you need and press **OK**.

To hide the device keys, press **(Back)**.

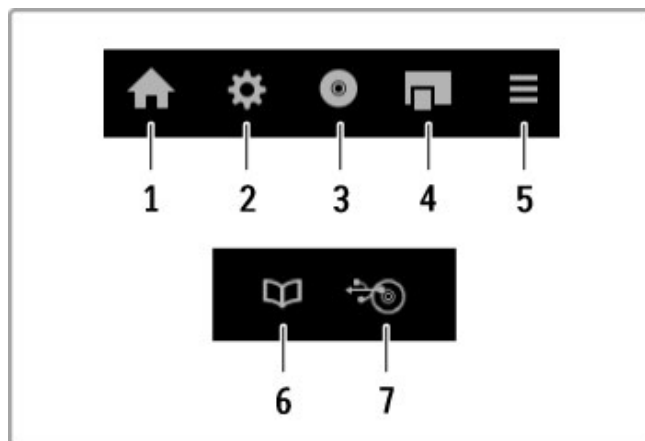

In general, these keys open the following device menus:

- 1 Home menu
- 2 Setup menu
- 3 Disc menu (disc content)
- 4 Pop-up menu
- 5 Options menu
- 6 Programme guide
- 7 Media selection

Read more about EasyLink in **Help > Setup > Devices > EasyLink HDMI-CEC**.

2.6 Subtitles, timers and locks

Subtitles

Programme subtitles are available most of the time. You can switch subtitles on or off. How to set subtitles depends on whether a channel is analogue or digital.

Switch on subtitles

To open the Subtitle menu, press **SUBTITLE**. You can switch subtitles **On** or **Off**. Select **On during mute** to show subtitles only when the sound is muted with .

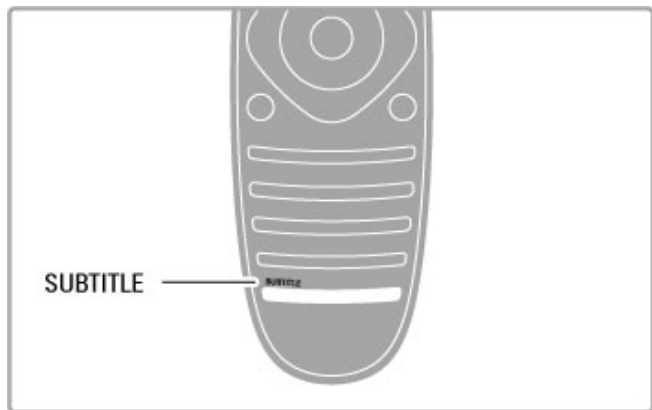

For analogue channels

To make subtitles available for a channel, switch to the channel and press **TEXT** to open Text. Enter the page number for subtitles, usually 888, and press **TEXT** again to close Text. With subtitles switched on in the Subtitle menu, subtitles will be shown if available. Each analogue channel must be set up separately.

For digital channels

There is no need to activate subtitles in Text for digital channels. You can set a preferred primary and secondary subtitle language. If these subtitle languages are not available for a channel, you can select another available subtitle language.

To set the primary and secondary subtitle language, press  and select **Setup > Channel settings** and select **Languages > Primary** and **Secondary subtitles**.

To select a subtitle language when none of your preferred languages is shown, press  **OPTIONS**, select **Subtitle language** and select a language you want temporarily.

Audio languages

Digital TV channels can broadcast audio that transmits several languages for a programme. You can set the TV to switch to your preferred language if it is available.

Set your language

To set your preferred audio language, press  and select **Setup > Channel settings** and select **Languages > Primary** and **Secondary audio**. The TV will automatically switch to one of your languages, if one of them is available.

To check if an audio language is available, press  **OPTIONS** and select **Audio language**. You can select another audio language from the list.

Some digital TV channels broadcast special audio and subtitles adapted for people who are hearing or visually impaired. Read **Help > Setup > Universal access**.

Child locks

To prevent children from watching a channel or a programme, you can lock channels or lock age-rated programmes.

Parental rating

Some digital broadcasters have rated their programmes. When the rating is equal or higher than the rating you have set for your child's age, the programme will be locked.

To watch a locked programme you must enter the child lock code. The parental age rating is set for all channels.

Set an age rating

Press  and select **Setup > Channel settings** and select **Child lock > Parental rating**.

To select an age rating, you must first enter your 4-digit child lock code. If no child lock code is set, you can set the code now.

When the code is entered, you can select the age rating. When the rating of a programme is equal or higher than the rating you have set for your child's age, the programme will be locked. The TV will ask for the code to unlock the programme. For some operators, the TV only locks programmes with a higher rating.

Lock a channel

To lock a channel, press  and select **Setup > Channel settings** and select **Child lock > Channel lock**. In the list of channel numbers, select a channel and press **OK** to lock a channel.

In the list, a locked channel is marked with an **X**. Now, you can select another channel to lock or unlock. The lock is activated as soon as you close the menu.

You cannot lock programmes from connected devices.

Change code

To change the current lock code, press  and select **Setup > Channel settings** and select **Child lock > Change code**. Enter the current code and then enter the new code twice. The new code is set.

Forgotten your code?

If you have forgotten your code to unlock, call Consumer Care in your country. Find the telephone number on the documentation that came with the TV or go to www.philips.com/support.

Sleep timer

With the sleep timer, you can set the TV to switch to standby automatically after a specified time.

To set the sleep timer, press  **> Setup > TV settings > Preferences > Sleep timer**. With the slider bar you can set the time up to 180 minutes in increments of 5 minutes. If set to 0 minutes, the sleep timer is switched off.

You can always switch off your TV earlier or reset the time during the countdown.

3 Smart TV

3.1 Net TV

What is Net TV?

Net TV offers Internet applications called apps. These apps are tailored for your TV. With these apps you can read your national newspaper, look at infotainment, or rent a movie from a video store or watch programmes you missed with catch-up TV apps. A wide range of Net TV apps are available depending on your country.

Smart USB Recording

With your TV connected to the Internet, you can also record programmes from the TV programme guide. To record programmes, you must connect a USB Hard Disk Drive to your TV. (Only in selected countries.)

Net TV specifics

- The availability of Net TV apps varies per country.
- With Net TV, you can view any Internet website you like but most of them are not tailored for a TV screen and some plug-ins (e.g. to view pages or videos) are not available on your TV.

- Net TV apps can be added, changed or stopped.
- Net TV shows one page at a time and full screen.
- You cannot download and save files or install plug-ins.

Net TV forum website

Find out more on Net TV apps at the Net TV forum website. www.supportforum.philips.com

TP Vision Netherlands B.V. bears no responsibility regarding the content and the quality of the content provided by the content service providers.

What you need

To enjoy Net TV you must connect the TV to a router with a high-speed (broadband) connection the Internet. You can use a home network connected to the Internet. You do not need a computer.

Read more about connecting to your home network in **Help > Setup > Network**.

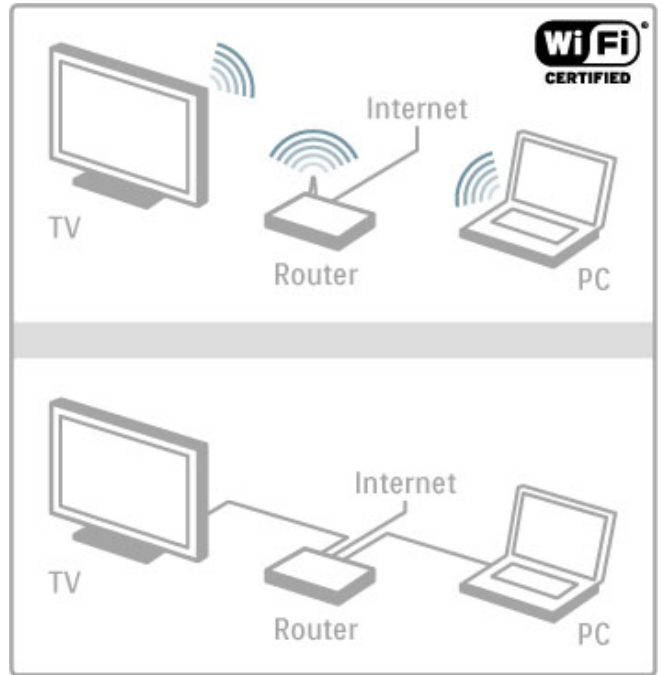

Keyboard and mouse

To enter text or to navigate a page, you can connect a USB keyboard and a USB mouse to the TV. The USB mouse can only navigate pages on the Internet, it cannot navigate Net TV app pages.

Read more about connecting a keyboard or mouse in **Help > Connections > Connect more devices > Keyboard and mouse**.



Configure

The first time you open Net TV, you must agree to the terms and conditions before you can continue. Press **OK** to agree. Press **↩** (Back) to quit Net TV.

Register

If you agree, you can register with Club Philips. Select Register and press **OK**. Enter your email address, select **Continue** and press **OK**. Confirm the email address.

Parental control

To lock Adult 18+ rated apps, switch on Net TV parental control by selecting **Enable** and then press **OK**. Enter an unlock PIN code of your choice. Confirm your PIN code. Adult 18+ rated apps are now locked.

To open a locked app, select the app and press **OK**. The TV will ask you to enter your 4-digit code.

Clear Net TV memory

To redo the Net TV configuration and to clear all passwords, PIN codes, history and cookies, press **Home** (Home), select **Setup** > **Network settings** > **Clear Net TV memory**.

Net TV apps

Open Net TV

To open Net TV, press **Home** (Home), select **Browse Net TV** and press **OK**.

To close Net TV, press **Home** (Home) and select another TV activity.

The Net TV home page

When you open Net TV, the home page is shown.

To navigate the page, press **Up**, **Down**, **Left** or **Right**.

To open an app, select the app and press **OK**.

To go back 1 step, press **Back**.

The home page

- 1 The App Gallery
- 2 Your Apps
- 3 The Internet App
- 4 Current TV channel



The App Gallery

To look for apps to add to your home page, select **App Gallery** and press **OK**.

To add an app to the home page, select an app in the list and press **Add**.

To search per category, select the category field (All) and press **OK**.

To open the on-screen keyboard, select a text entry field and press **OK**.

To switch to the app gallery of another country, select the country field and press **OK**.

Lock or remove an app

To lock or remove an app, select the app and press **Options**. Select the option and press **OK**.

Reload an app or page

To retry loading an app or an Internet page, press **Options** and select **Reload page**.

Security info

To view the level of security of the page you're on, press **Options** and select **Security info**.

Internet websites

To browse Internet websites, select the **Internet** app on the Net TV home page and press **OK**.

To open the on-screen keyboard, select a text entry field and press **OK**.

To remove a visited website from the list, press **Options** and select **Remove from History**.

Rent a movie

With the video store apps in Net TV, you can rent your favourite movie from an online rental video store. You can pay securely with your credit card.

- 1 Open a video store app.
- 2 Select a video.
- 3 Make the online payment.
- 4 Download the video.
- 5 Start watching.

What you need

To rent and download a video, you need a high-speed (broadband) Internet connection to the TV. You also need an SD memory card.

Read more about connecting to the network in **Help** > **Setup** > **Network**.

Video memory

To download a video, you must format an SD memory card as video memory. Insert the SD card into the SD card slot on the side of the TV. The TV starts formatting the SD card automatically. The SD card may be rejected if the write speed is insufficient for video transfer. Once formatted, leave the card permanently in the slot.

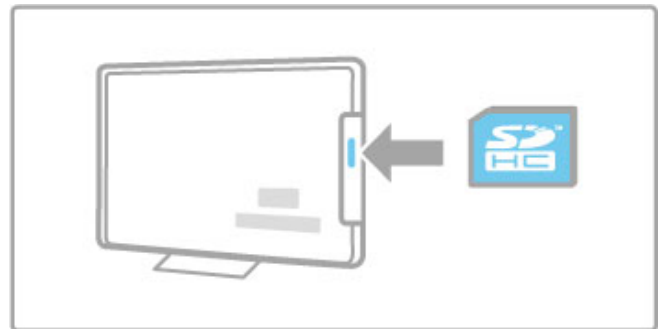

SD memory card size

Use a SD HC (High Capacity) memory card with at least 4GB of storage capacity.

For high-definition (HD) video, use an SD card with at least 8GB of storage capacity. Use a speed class 2 card or more.

Open a video store app

To open a video store, press **Home** (Home), select **Net TV** and press **OK**. Select a video store app from the Net TV home page. Select the video store and press **OK**. You can add a video store app on your home page from the app gallery. Availability of video stores varies by country.

Rent a video

When you open a video store you will be asked to log in or to create a log in account. With a text entry field selected, press **OK** to open the on-screen keyboard.

Consult the video store website for more information.

Online TV

With the online TV apps in Net TV you can watch programmes you missed. Most often, you can recognise such an online TV app by its broadcaster's logo.

What you need

To watch online TV programmes, you need a high-speed (broadband) Internet connection to the TV.

Read more about connecting to the network in **Help > Setup > Network**.

Watch online TV

To watch an online TV programme in Net TV, press **⬆** (Home), select **Browse Net TV** and press **OK**. Select the broadcaster app on the Net TV home page and press **OK**. You can add a online TV broadcaster app on your home page from the app gallery.

Start a programme

Select a programme from the online TV app page and press **OK**.

Most often, you can use the **▶** (Play) or **⏸** (Pause) keys on your remote control.

3.2 Interactive TV

What is iTV?

With interactive TV, some digital broadcasters combine their normal TV programme with information or entertainment pages. On some pages, you can respond to a programme or vote, do online shopping or pay for a video-on-demand programme.

HbbTV, MHEG, MHP, DTVi, . . .

Broadcasters use various interactive TV systems : HbbTV (Hybrid Broadcast Broadband TV) or iTV (Interactive TV - MHEG). Interactive TV is sometimes referred to as Digital Text or Red button. But each system is distinct. Visit the broadcasters Internet website for more information.

What you need

Interactive TV is only available on digital TV channels. To enjoy the full benefits of Interactive TV, you need a high-speed (broadband) Internet connection to the TV.

Read more about connecting to the network in **Help > Setup > Network**.

Open iTV pages

Most channels that offer HbbTV or iTV invite you to press the **red** key or **OK** key to open their interactive programme.

Close iTV pages

Most iTV pages inform you which key to use to close.

For Digital Text and Red button, press **↶** (Back).

To force an iTV page to close, switch to the next TV channel and switch back.

Navigate iTV pages

You can use the navigation and colour keys, the number keys and the **↶** (Back) key to navigate the iTV pages. You can use the **▶** (Play), **⏸** (Pause) and **■** (Stop) keys to watch videos within iTV pages.

Digital Text (UK only)

To open Digital Text, press **TEXT**. To close, press **↶** (Back).

HbbTV links

Some HbbTV pages have links to the Internet. Your TV switches to Net TV to view these Internet websites. To switch back to normal TV viewing, you might need to press **🏠** (Home) and select **Watch TV** again to continue watching the TV channel.

Block HbbTV pages

To block the HbbTV pages from a specific channel, tune to the channel, press **≡** **OPTIONS** and select **HbbTV on this channel** and select **Off**.

To block HbbTV on all channels, press **🏠** (Home), select **Setup** and select **TV settings > HbbTV** and select **Off**.

3.3 Videos, photos and music

Browse USB

You can view photos or play your music and videos from a USB memory device.

Insert a USB device into the USB connection on the left-hand side of the TV while the TV is switched on. The TV detects the device and opens a list showing its content. If the list does not appear automatically, press **HOME**, select **Browse USB** and press **OK**.

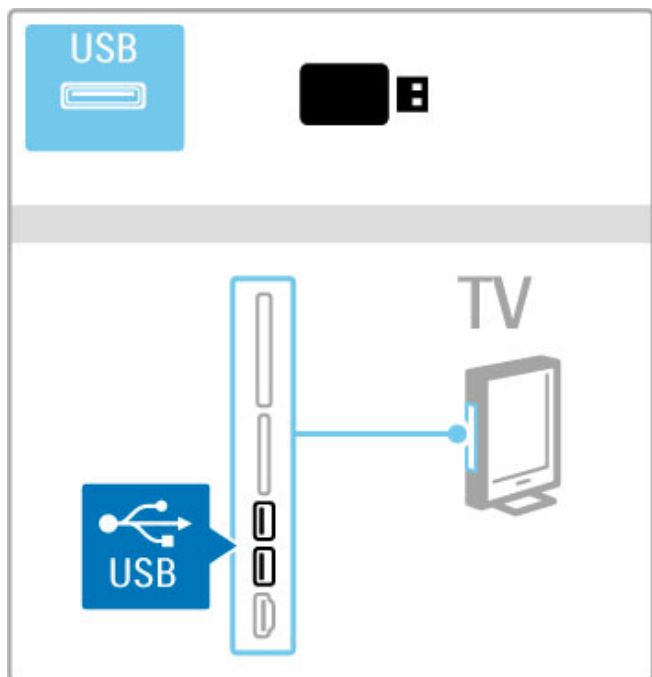

To close Browse USB, press **HOME** and select another activity or disconnect the USB device.

View photos

To view photos, select a photo in the list and press **OK**. If there are more photos in the folder, the TV starts a slideshow with these photos.

To stop, press **OPTIONS** and select **Stop**.

To pause or play the slideshow again, press **OK**.

To view the next photo, press **▶**.

To view the previous photo, press **◀**.

Options for photos

Press **OPTIONS** to select the following:

- Show info
- Stop
- Play once / Repeat
- Rotate
- Shuffle on / off
- Slideshow speed
- Slideshow transition
- Set as Scenea

Shuffle on

Plays the files randomly.

Set as Scenea

Sets the current photo as a wallpaper photo for Scenea.

Play videos or music

To play videos or music, select the file in the list and press **OK**. If there are more music or video files in the folder, the TV plays the files one after the other. To stop, press **OPTIONS**.

To pause or play, press **OK**.

To play the next file in the folder, press **▶**.

To play to the previous file, press **◀**.

To fast forward, press **▶**.

To rewind, press **◀**.

Options for music and videos

Press **OPTIONS** to select the following:

- Stop
- Play once / Repeat
- Shuffle on / off

Music with photos

You can play music and show photos at the same time. Start the photo slideshow after you started the music.

1 Select a folder with music files and press **OK**.

2 Select a folder with photo files and press **OK**.

To stop, press **OPTIONS** and select **Stop**.

Screen off

If you only listen to music, you can mute the TV screen to save energy.

To mute the screen, press the **GREEN** key, select **Screen off** and press **OK**. To switch the screen back on, press any key on the remote control.

See the list of compatible playback formats in **Help > Specifications > Multimedia**.

Browse PC

You can view photos or play your music and videos from a PC in your home network.

The TV is DLNA certified and is compatible with other DLNA certified devices.

What you need

To browse your PC files, you need to connect the TV to your home network. Also, do not forget to set your media server software to share the files with the TV.

Browse PC

To browse your PC files, press **HOME**, select **Browse PC** and press **OK**.

To close Browse PC, press **HOME** and select another activity.

If the network is not yet installed when you select Browse PC, the Network installation starts automatically. Follow the instructions on screen.

To select, view and play your files, read **Help > Smart TV > Videos, photos and music > Browse USB**.

Find the list of compatible playback formats and compatible media server software in **Help > Specifications > Multimedia**.

Read more about connecting to a network in **Help > Setup > Network**.

Scenea

With Scenea, you can set a photo as a painting on your TV screen. Select your favourite photo from your collection.

To open Scenea, press **HOME**, select **Scenea** and press **OK**. If you did not yet select a photo of your own, a preset photo is shown. To close the Scenea photo, press a key on the remote control.



Select a photo for Scenea

- 1 Select a photo from a connected USB device or from a connected PC. This photo must be in JPEG format.
- 2 With the photo highlighted in the Browse USB or Browse PC list, press **≡ OPTIONS**, select **Set as Scenea** and press **OK**. By agreeing to overwrite the current photo, the new photo is set.

Scenea lounge light

To switch off Ambilight when Scenea is on, press **≡ ADJUST**. Or press **Ambilight** on the front of the TV.

Energy saving

To switch the TV to the energy saving mode, press **≡ ADJUST**, select **Smart picture** and press **OK**. Select **Energy saving**.

Specifics

With Scenea switched on, the TV will automatically switch to standby after 4 hours. You will be warned 1 minute before switch off. This automatic switch to standby prevents unnecessary energy use in case you forget that Scenea is on.

If the sleep timer is set, the TV will also switch to standby after the set time has elapsed.
Scenea has no sound.

Wi-Fi Media Connect

With Wi-Fi MediaConnect you can bring up (project) your PC screen on to the TV screen wirelessly. You can project video, music, presentations or other content playing on your laptop or desktop PC.

Before you can project the PC screen on to TV, you must install the Wi-Fi MediaConnect software on your PC.
Read more about installing the Wi-Fi MediaConnect software in **Help > Setup > Network > Wi-Fi MediaConnect**.

Start projecting

To start projecting the PC screen on to the TV, click on the small TV icon in the taskbar at the bottom right of the PC screen. Your PC screen appears on your TV screen.

Stop projecting

To stop projecting, click on the TV icon again.

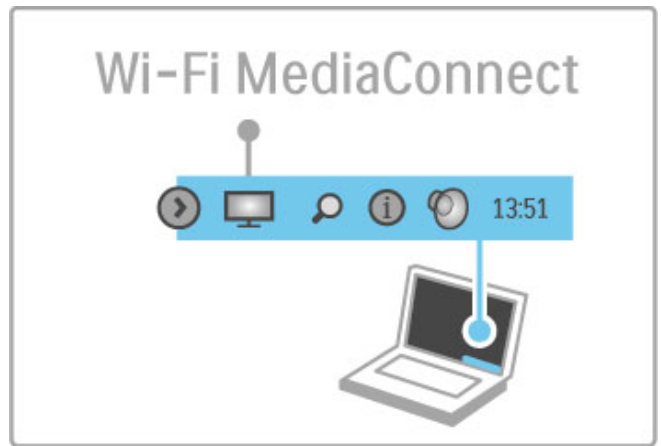

Wi-Fi MediaConnect Help

To read the Wi-Fi MediaConnect Help, right-click the TV icon in the taskbar of the PC and select **Help**.

Specifics

The playback of video can be affected by your PC performance and your wireless network bandwidth.

You can project high definition (HD) or standard definition (SD) video, depending on the processing power of your PC.
The content protection on most DVD or Blu-ray Disc movies might restrict watching the movie on a TV when the disc is playing on a PC.
The TV shows PC media files with a small delay.

3.4 Pause TV and recording

Smart USB recording

With this TV you can pause a TV broadcast from a digital channel. You can pause a TV broadcast to watch it later. Simply connect a USB Hard Drive device to your TV and you can pause the broadcast.

If your TV is connected to the Internet, you can also record or set a programmed recording of a digital broadcast. In some countries, recording is not supported.

What you need

Smart USB recording and Pause TV only work with digital TV channels (DVB broadcast or similar).

To pause

To pause a digital broadcast you need to connect a **USB Hard Drive**. Use a USB 2.0 compatible Hard Drive device with a minimum of 32GB Hard Drive space and a minimum writing speed of 30MB/s. Connect the USB Hard Drive to one of the two USB connectors on the side of the TV.

To record

First, check if the Programme guide supports recording. With the Internet connected, press **Home** and select **Programme guide**. If there is a **Recordings** button on the Programme guide page, you can record programmes.

To record programmes, you need a USB 2.0 compatible Hard Drive with 250GB and a high-speed (broadband) Internet connection to the TV.

Read more about connecting to the network in **Help > Setup > Network**.

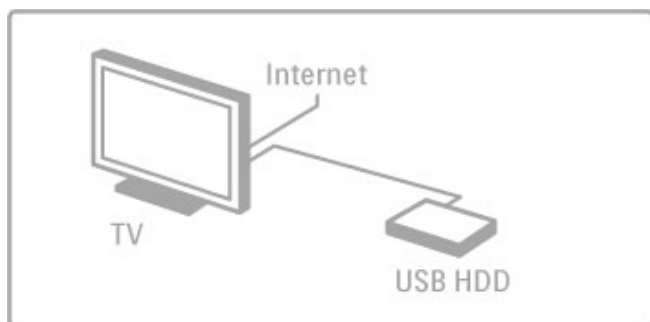

USB Hard Drive installation

Before you can pause or record a broadcast, you must format the connected USB Hard Drive.

1 Connect the USB Hard Drive to one of the two USB ports on the side of the TV. Do not connect another USB device to the other USB port when formatting.

2 Switch on the device and the TV.

3 When the TV is tuned to a digital TV channel, press **Pause** to start formatting. Formatting will remove all data from the connected USB Hard Drive. Follow the instructions on screen. When the USB Hard Drive is formatted, leave the device connected permanently.

Warning

The USB Hard Drive is formatted exclusively for this TV, you cannot use the stored recordings on another TV or PC. Do not copy or change recording files on the USB Hard Drive with any PC application. This will corrupt your recordings. When you format another USB Hard Drive, the content on the former will be lost.

Pause TV

While watching a TV broadcast from a digital channel, you can pause the broadcast and continue watching later on. Answer a phone call or take a break. Meanwhile, the broadcast is stored on the USB Hard Drive. You can pause a broadcast for a maximum time span of 90 minutes.

To pause a TV broadcast, press **Pause** (Pause). A progress bar appears briefly on screen.

To call up the progress bar, press **Pause** (Pause) again.

To continue watching, press **Play** (Play).

To switch to TV broadcast again, press **Stop** (Stop).

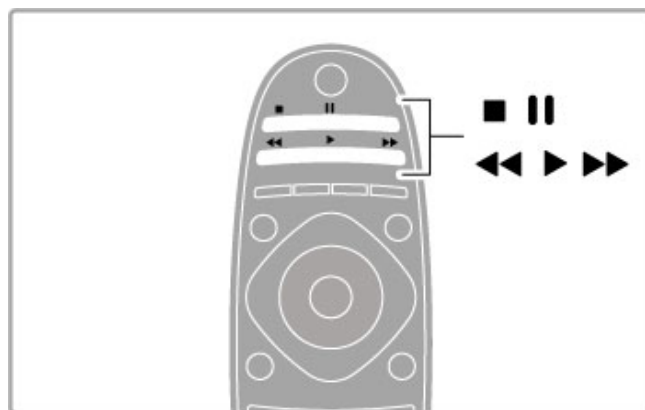

Once you switch to a digital channel, the USB Hard Drive starts storing the broadcast. When you switch to another channel, the new channel broadcast is stored and the broadcast of the former channel is cleared. Also when you switch the TV to standby, the stored broadcast is cleared.

When you start watching a programme of another device - a connected Blu-ray Disc player or digital receiver - the USB Hard Drive clears all broadcast storage. Whilst recording a programme on the USB Hard Drive, you cannot pause a TV broadcast.

Instant replay

Whilst watching a TV broadcast from a digital channel, you can easily instant replay the broadcast.

To replay the last 10 seconds of a TV broadcast, press **Pause** and press **Left** (Left).

You can press **Left** repeatedly until you reach the start of the broadcast storage or the maximum time span.

Progress bar

With the progress bar on screen, press **Rewind** (Rewind) or press **Fast Forward** (Fast Forward) to select from where you want to start viewing the stored broadcast. Press these keys repeatedly to change their speed.

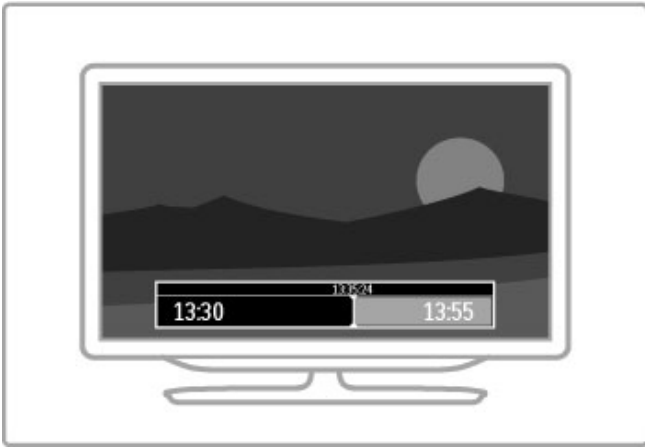

Specifics

The Audio Description audio (commentary) for the visually impaired is not available for playback in Smart USB Recording.

Recording

If the TV is connected to the Internet and there is a **Recordings** button on the Programme guide page, you can record a digital TV broadcast on the USB Hard Drive. You can manage all recordings in the **Programme guide** on TV.

If the **Recordings** button is not available, check if the Programme guide data is set to update from the network. Press **Home** and select **Setup > TV settings > Preferences > Programme guide > From network**.

Record now

To record the programme you are watching, press **Record**. While the recording has already started, you can adjust the end time of the recording in the pop-up window of the Programme guide. Press **Schedule** to confirm the end time.

To stop recording immediately, press **Stop**.

Schedule a recording

You can schedule a recording of an upcoming programme for today or a few days from today (maximum of 8 days away).

1 To schedule a recording, press **Home** and select **Programme guide**. On the Programme guide page, select the channel and programme you wish to record.

You can enter the channel number to jump to the channel in the list. Press **Right** or **Left** to scroll the programmes of a channel.

To change the date of the list, select the date at the top of the page and press **OK**. Select the day you want and press **OK** again.

2 With the programme highlighted, press **OPTIONS** and select **Record**. The TV adds some time buffer at the end of the program. You can add some extra buffer if needed.

3 Select **Schedule** and press **OK**. The programme is scheduled for recording. A warning will show automatically when overlapping recordings are scheduled.

If you plan to record a programme in your absence, remember to leave the TV on standby and the USB Hard Drive switched on.

List of recordings

To view the list of recordings and scheduled recordings, select **Recordings** on the Programme guide page and press **OK**. In this list, you can select a recording to watch, remove recorded programmes, check the free drive space or schedule a recording not linked to a specific TV programme.

Expired recording

Broadcasters can limit the number of days a recording can be viewed. A recording in the list can show the number of days before it expires.

Failed recording

When a scheduled recording was prevented by the broadcaster or when the download was interrupted, a recording is marked as **Failed**.

Watch a recording

In the list of recordings, select the arrow in front of the recording and press **OK**. The playback of the recording starts. You can use the **Play**, **Forward**, **Rewind**, **Pause** or **Stop** keys on the remote control.

Set a timed recording

To set a recording not linked to a programme, select **Schedule recording** above the list of recordings and press **OK**. Set the channel, date and time span. To confirm the recording, select **Schedule** and press **OK**.

Remove a scheduled recording

To remove a scheduled recording, select the red circle in front of the recording and press **OK**.

Delete a recording

To remove a recording, select the recording in the list and press **OPTIONS** and select **Delete recording**.

Programme information

To view more information on a programme, select the programme in any programme guide list and press **OK**. Depending on the status of this programme you can start watching, schedule its recording, playback the recording or delete the recording from this page.

Specifics

- While recording a programme, you can watch a previously recorded programme.
- While recording, you cannot switch TV channels.
- While recording, you cannot pause the TV broadcast.

- The Audio Description audio (commentary) for the visually impaired is not available for playback in Smart USB Recording.

3.5 Games

Play a game

Add a game console

In the Home menu, start **Add your devices** to add the console to the Home menu for easy selection later on. When adding a game console to the Home menu, select **Game** when the TV asks for the device type. If your game console is an EasyLink HDMI-CEC device it might add itself to the Home menu.



Smart setting - Game

The Smart picture setting **Game** sets the TV to the ideal Game settings without picture lag.

If your game console is added as **Game** in the Home menu, the TV switches to the Game setting automatically.

If your game console has added itself in the Home menu as a **Blu-ray Disc player** or **DVD player**, you need to switch the Smart picture setting to **Game** before you start playing.

To switch the Smart picture setting to Game, press **⏏ ADJUST** and select **Smart picture > Game** and press **OK**. The TV is ready for gaming. Do not forget to switch back to your normal Smart picture setting when you stop gaming.

Read more about how to connect a game console in **Help > Connections > Connect more devices > Game** or **HD Game**.

Two-player games

Some games offer multi-player and split screen gaming. On this TV, you can set the split screen as two full screen views. Two players watch the same TV but see two different screens to play the game. The TV uses 3D technology to do this. To watch each screen, you need a pair of 3D glasses for each player.

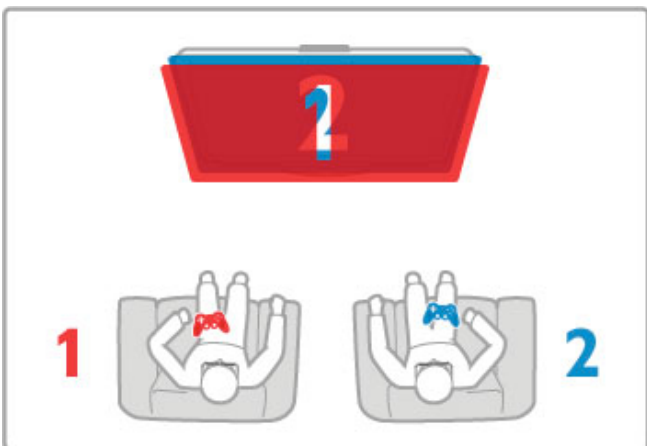

What you need

With this TV, use the active 3D glasses - Philips PTA516 (sold separately).

For two-player split screen gaming, the game console must be connected with HDMI.

Start a two-player game

1 Select the game console in the **Home** menu and press **OK**.

2 On the game console, start the game and select the multi or two-player mode. Select the mode for split screen viewing.

3 On the TV, press **⏏ ADJUST** and select **Two-player game**.

4 Select the format in which the split screen game is shown on screen, **Side by side** or **Top / bottom** and press **OK**. The TV shows the 2 screens as full screens.

To watch the 2 different screens, put on the 3D glasses.

To switch the glasses to watch the Player 1 screen or Player 2 screen, press the **Player 1/2** selection key on the glasses.

In and out of split screen view

In two-player split screen view, you can switch back and forth from split screen to combined view, to be able to read the game menu or game scores.

To switch views back and forth, press **OK** on the remote control of the TV.

Stop Two-player game

To stop the two-player split screen view, press **⏏** (Home) and select another activity.

Specifics

To make Two-player gaming available in the menu, select **3D** in the same menu, select **2D** in the list and press **OK**.

3.6 Text

Text pages

Open Text

To access Text while you are watching TV channels, press **TEXT**.

To close Text, press **TEXT** again.

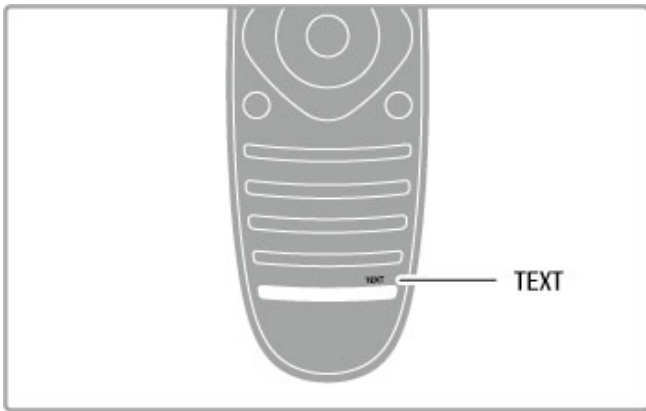

Select a Text page

To select a page ...

- Enter the page number with the number keys.
- Press **▶** or **◀**
- Press **▲** or **▼**.
- Press a colour key to select a colour-coded subject at the bottom of the screen.

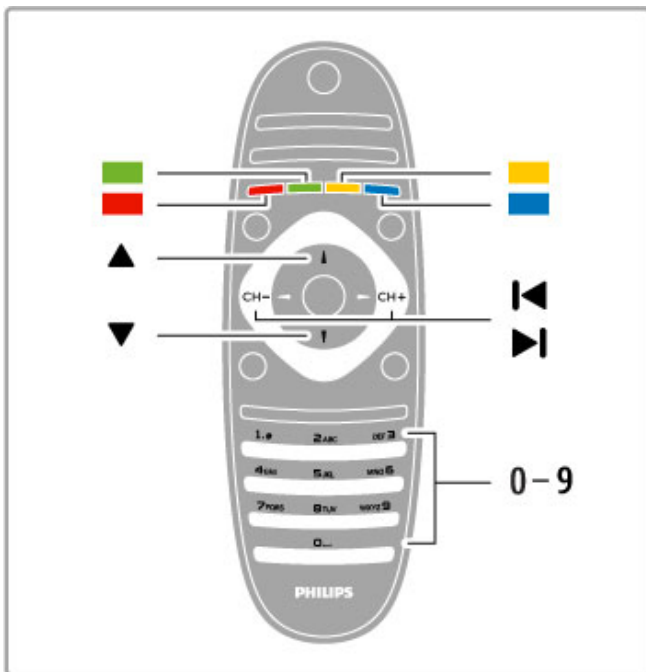

Text sub-pages

A Text page number can hold several subpages. The subpage numbers are shown on a bar next to the main page number.

To select a subpage, press **◀** or **▶**.

T.O.P. Text pages

Some broadcasters offer T.O.P. Text.

To open T.O.P. Text pages within Text, press **≡** **OPTIONS** and select **T.O.P. overview**.

Search Text

You can select a word and scan Text for all occurrences of this word.

Open a Text page and press **OK**. Select a word or number with the navigation keys. Now press **OK** again to jump immediately to the next occurrence of this word or number. Press **OK** again to jump to the subsequent occurrence.

To stop the search, press **▲** until nothing is selected.

Text from a connected device

Some connected devices that receive TV channels can also offer Text.

To open Text from a connected device, press **▲**, select the device and press **OK**. While watching a channel on the device, press **≡** **OPTIONS**, select **Show device keys** and select the **≡** key and press **OK**. Press **↶** (Back) to hide the device keys. To close Text, press **↶** (Back) again.

Digital Text (UK only)

Some digital TV broadcasters offer dedicated Digital Text or interactive TV on their digital TV channels. This includes normal Text using the number, colour and navigation keys to select and navigate.

To close Digital Text, press **↶** (Back).

Text options

In Text, press **≡** **OPTIONS** to select the following:

- Freeze page
- Dual screen
- T.O.P. overview
- Enlarge
- Reveal
- Cycle subpages
- Language

Freeze page

To stop the automatic rotation of subpages, press **≡** **OPTIONS** and select **Freeze page**.

Dual screen / Full screen

To show the TV channel and Text alongside each other, press **≡** **OPTIONS** and select **Dual screen**. Select **Full screen** to switch back to full screen view.

T.O.P. overview

To open T.O.P. Text, press **≡** **OPTIONS** and select **T.O.P. overview**.

Enlarge

To enlarge the Text page for more comfortable reading, press **≡** **OPTIONS** and select **Enlarge**. To scroll down the page, press **▼** or **▲**.

Reveal

To unhide hidden information on a page, press **≡** **OPTIONS** and select **Reveal**.

Cycle subpages

To cycle subpages when these are available, press **≡** **OPTIONS** and select **Cycle subpages**.

Language

To switch the group of characters that Text uses to display correctly, press **≡** **OPTIONS** and select **Language**.

Text setup

Text language

Some digital TV broadcasters have several Text languages available.

To set your primary and secondary Text language, press **🏠** > **Set up** > **Channel settings** and select **Primary** or **Secondary Text** and select your preferred Text languages.

Text 2.5

If available, Text 2.5 offers more colours and better graphics. Text 2.5 is activated as a standard factory setting.

To switch it off, select **🏠** > **Setup** > **TV settings** > **Preferences** > **Text 2.5**.

4 Setup

4.1 Picture and sound

Picture

In the Picture menu, you can adjust all picture settings individually.

To open the Picture settings, press **⬆** > **Setup** > **TV settings** > **Picture**.

- **Contrast**

Sets the contrast level of the picture.

- **Brightness**

Sets the brightness level of the picture.

- **Colour**

Sets the level of colour saturation.

- **Hue**

If NTSC is broadcast, hue compensates the colour variations.

- **Sharpness**

Sets the level of sharpness of fine detail.

- **Noise reduction**

Filters out and reduces the image noise in the picture.

- **Tint**

Sets the colours to **Normal**, **Warm** (reddish) or **Cool** (bluish).

Select **Custom** to set up your own personal settings in the Custom menu.

- **Custom tint**

Use the slider bar to set the colour temperature of the picture.

- **Perfect Pixel HD**

Controls the advanced settings of the Perfect Pixel HD Engine.

— **Perfect Natural Motion** removes motion judder and reproduces smooth movement, especially in movies.

— **Clear LCD** gives a superior motion sharpness, better black level, high contrast with a flicker-free, quiet image and a larger viewing angle.

— **Super resolution** enables superior sharpness, especially on lines and contours in the picture.

— **Perfect contrast** sets the level at which the TV automatically enhances the details in the dark, middle and light areas of the picture.

— **Dynamic backlight** sets the level at which power consumption can be reduced by dimming the brightness intensity of the screen. Choose for the best power consumption or for the picture with the best brightness intensity.

— **MPEG artefact reduction** smooths the digital transitions in the picture.

— **Colour enhancement** makes the colours more vivid and improves the resolution of details in bright colours.

— **Gamma** is a non-linear setting for picture luminance and contrast. Use the slider bar to set a higher or lower gamma value.

- **PC mode**

Sets the TV to the ideal pre-defined computer setting if a computer has been connected.

- **Light sensor**

Adjusts the picture and Ambilight settings automatically to the lighting conditions of the room.

- **Picture format**

Read **Help** > **Basics** > **Watch TV** > **Picture format**.

- **Screen edges**

Slightly enlarge the picture to hide distorted edges.

- **Picture shift**

Move the picture up / down or left / right with the cursor keys.

Sound

In the Sound menu, you can adjust all sound settings individually.

To open Sound settings, press **⬆** > **Setup** > **TV settings** > **Sound**.

- **Bass**

Sets the level of low tones in the sound.

- **Treble**

Sets the level of high tones in the sound.

- **Surround**

Sets the surround sound effect from internal speakers.

- **Headphones volume**

Sets the volume for the headphone connection of the TV.

- **Auto volume levelling**

Reduces sudden volume differences like at the beginning of adverts or when switching from one channel to another.

- **Balance**

Sets the balance of the left and right speakers to best fit your listening position.

Eco settings

Eco settings bundle the TV settings that help the environment.

While you are watching TV channels, press the **Green** key to open **Eco settings**. Active settings are marked with a . Press again to close.

- **Energy saving**

This Smart picture setting sets the picture, together with Ambilight, in the most ideal energy conscious setting. To switch on, select **Energy saving** in Eco settings and press **OK**.

To switch off Energy saving, select another Smart picture setting.

- **Screen off**

If you only listen to music, you can switch off the TV screen to save energy. Select **Screen off** and press **OK**. To switch the screen back on, press any key on the remote control.

- **Light sensor**

The built-in light sensor automatically adjusts the picture, together with Ambilight, to the lighting conditions of the room. To switch on, select **Light sensor** and press **OK**. To switch off, press **OK** again.

- **Auto switch off**

If no keys on the TV remote control were pressed during a 4-hour period, the TV switches off automatically to save energy. You can switch off this **Auto switch off**.

If you use the TV as a monitor or use a digital receiver to watch TV (a set top box - STB) and you do not use the remote control of the TV, switch off the automatic switch off.

Smart settings

If you select a Smart setting in the ADJUST menu, you can again change the settings of the selected Smart setting with the Picture and sound settings in Setup. The Smart setting remembers your changes.

Reset a Smart setting

To reset a Smart setting to its original values, select the Smart setting you want to reset in the ADJUST menu. Then press **⬆** > **Setup** > **TV settings** > **Picture**, select **Reset**, press **OK** and confirm.

Read more about using Smart picture and sound settings in **Help** > **Basics** > **Watch TV** > **Smart picture and sound settings**.

ISF Calibration

Get the most out of your HD TV display with ISF Calibration. An ISF calibration expert comes to your home and sets the TV to the most optimal picture setting. Additionally the expert can set an ISF Calibration for Ambilight.
Ask your dealer for an ISF Calibration of your TV.



The ISF Calibration expert stores and locks the ISF settings as 2 Smart picture settings. Once the ISF Calibration is done, press **⏸** **ADJUST**, select **Smart picture** and press **OK**. Select **ISF Day** to watch TV during bright light conditions or select **ISF Night** for dark light conditions.

An ISF Calibration can be done on every activity in the Home menu, like Watch TV or a connected Blu-ray Disc player.

Calibration benefits are . . .

- better picture clarity and sharpness
- better detail in bright and dark parts
- deeper and darker blacks
- better colour purity and quality
- reduced energy consumption

Expert picture settings

When **ISF Day** or **ISF Night** is selected while an ISF Calibration is not yet performed on the TV, some expert picture settings are available. Press **⬆** (Home) > **Setup** > **TV settings** > **Picture** > **ISF expert settings** and press **OK**.

Reset Smart picture settings

To reset a Smart setting to its original values, select the Smart setting you want to reset in the ADJUST menu. Then press **⬆** (Home) > **Setup** > **TV settings** > **Picture**, select **Reset**, press **OK** and confirm.

4.2 Ambilight

Placement

For the best Ambilight effect :

- Dim the lighting conditions in the room and position the TV up to 25 cm away from the wall.
- Adjust Ambilight according to the colour of your wall at home in the Wall colour setting.
- To prevent poor infrared remote control reception, position your devices out of sight of Ambilight.

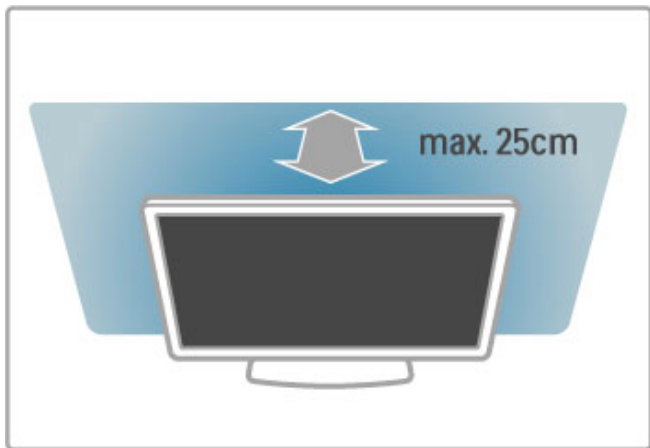

Adjust

To open the Adjust menu, press **||||** ADJUST.

To close, press **||||** again.

Switch Ambilight on or off

In the Adjust menu, select **Ambilight** and press **OK**. Switch Ambilight **On** or **Off**. You can also press Ambilight on the TV.

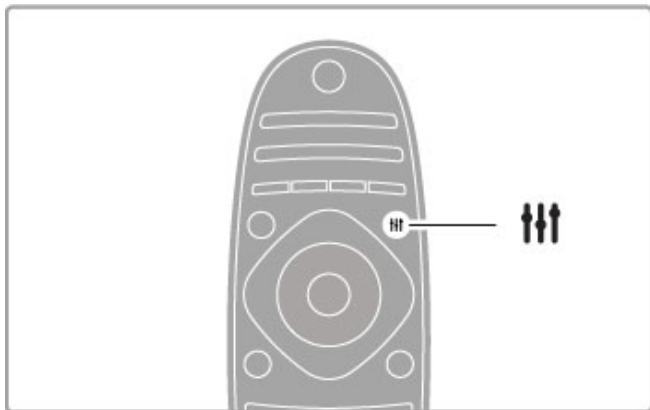

Ambilight dynamic

In the Adjust menu, select **Ambilight dynamic** and press **OK**. Adjust the speed at which Ambilight responds to onscreen images.

Read more about other Ambilight settings in **Help > Setup > Ambilight > Settings**.

Settings

More Ambilight settings are available in the Ambilight settings menu in Setup. To change these settings, press **⬆** and select **Setup > TV settings > Ambilight**.

Ambilight brightness

To set the Ambilight brightness, select **Ambilight brightness** and press **OK**. Adjust the light output of Ambilight.

Ambilight colour

To set the Ambilight colour, select **Ambilight colour** and press **OK**. Select **Dynamic**, if Ambilight should respond to onscreen images or select one of the fixed colours. Select **Custom** if you want to set a specific fixed colour.

Custom colour

To set an Ambilight colour of your own, select **Custom** in the Ambilight **Colour** menu. With Custom selected, you can open the **Custom colour** menu. Select **Palette** to choose your own colour. Ambilight Custom colour is a fixed (non-dynamic) colour setting.

Separation

To set the difference in colour level between the lights on each side of the TV, select **Separation**. Separation **Off** gives a dynamic but uniform Ambilight colour.

TV switch off

To set Ambilight to fade out and switch off a few seconds after you have switched off the TV, select **TV switch off**. Allow Ambilight to fade out and switch off completely before you switch the TV back on again.

Lounge light mood

Read more about Lounge light mood in **Help > Setup > Ambilight > Lounge light mood**.

Scenea lounge light

To always switch off Ambilight when Scenea is switched on, select **Scenea lounge light** and select **Off**.

Wall colour

The colour of the wall behind your TV can influence the colour effect of Ambilight. To correct this influence, select **Wall colour** and select a colour that matches the wall colour. Ambilight will correct its colours to mix best with the colour of the wall behind the TV.

Lounge light

When the TV is on standby, you can switch Ambilight on and create a Lounge light effect in your room.

To switch Ambilight on while the TV is on standby, press **Ambilight** on the TV.



To change the Lounge light colour scheme, press **Ambilight** on the TV again.

To switch off Lounge light, press and hold **Ambilight** on the TV for 3 seconds.

You can also set up the colour scheme in the Setup menu.
With the TV switched on, press **🏠** and select **Setup**. Select **TV settings > Ambilight > Lounge light mood**. Select the colour scheme with which Lounge light will start up.

4.3 Channels

Reorder and rename

You can reorder and rename channels in the Channel list.

To reorder or rename a channel, read **Help > Basics > Watch TV > Channel list**.

Update channels

The TV puts all installed channels in the Channel list. If you receive digital channels, you can set the TV to automatically update the list with new channels. You can also start an update of the Channel list yourself.

Automatic channel update

Once a day, at 6 AM, the TV updates the channels and stores new channels. Empty channels are removed. For new or removed channels, a message is shown at TV start up. The TV must be in standby to automatically update channels.

To switch off the message at start up, press **🏠 > Setup > Channel settings** and press **OK**. Select **Channel installation > Channel update message** and select **Off**.

To switch off the automatic channel update, press **🏠 > Setup > Channel settings** and press **OK**. Select **Channel installation > Automatic channel update** and select **Off**.

Start an update

To start an update yourself, press **🏠 > Setup > Search for channels** and press **OK**. Select **Update channels** and press **OK**. Press **Start**. The update can take a few minutes. Follow the instructions on screen.

Reinstall channels

Reinstall channels

To reinstall only the channels, press **🏠 > Setup > Search for channels > Reinstall channels** and press **OK**. Select **DVB-T** or **DVB-C**. The channel search can take a few minutes. Follow the instructions on screen.

Full installation

To redo a full TV installation, press **🏠 > Setup > TV settings > Reinstall TV** and press **OK**. The installation can take a few minutes. Follow the instructions on screen.

You can reorder and rename channels in the Channel list.

Channel list copy

Channel list copy is intended for dealers and expert users.

With Channel list copy, you can copy the channels installed on one TV onto another Philips TV of the same range. With Channel list copy, you avoid the time-consuming channel search and you can offer a predefined channel list setup. The small file you copy fits every USB memory device.

Conditions

- Both TVs are from the same year range.
- Both TVs have the same product type suffix for DVB (H, K, M, T or D/00) in their type number and have the TV installed for the same country.

- Both TVs have the same hardware type. Check the hardware type on the TV type plate on the back of the TV. Typically noted as

Q . . . LA

- Both TVs have compatible software versions. When you upload, an on-screen message will warn you if software versions are not compatible.

Copy a Channel list

1 Switch on the TV which has its channels installed. Plug in a USB memory device.

2 Press **🏠 > Setup > TV settings > Preferences > Channel list copy > Copy to USB** and press **OK**. To copy the Channel list from this TV, you might be asked to enter the TV PIN code you entered during the installation.

3 When copying is done, unplug the USB memory device.

Now you can upload the copied Channel list onto another Philips TV.

Upload a Channel list

To a TV that's not yet installed

1 Plug in the power plug to start the installation and select language and country. You can skip Search for channels. Finish the installation.

2 Plug in the USB memory device that holds the Channel list of the other TV.

3 To start the Channel list upload, press **🏠 > Setup > TV settings > Preferences > Channel list copy > Copy to TV** and press **OK**. You might be asked to enter the TV PIN code of this TV.

4 The TV notifies if the Channel list is copied to the TV successfully. Unplug the USB memory device.

To an already installed TV

1 Verify the country setting of the TV. (To verify this setting, press **🏠 > Setup > Search for channels > Reinstall channels** and press **OK**. Press **↶** (Back) and later **Cancel** to leave the Search for channels.)

If the country is correct continue with step 2 hereunder.

If the country is not correct, you need to start a reinstallation. To start the reinstallation, press **🏠 > Setup > TV settings > Reinstall TV** and press **OK**. Select the correct country and skip the Search for channels. Finish the installation. When done, return to step 2.

2 Plug in the USB memory device that holds the Channel list of the other TV.

3 To start the Channel list upload, press **🏠 > Setup > TV settings > Preferences > Channel list copy > Copy to TV** and press **OK**. You might be asked to enter the TV PIN code of this TV.

4 The TV notifies if the Channel list is copied to the TV successfully. Unplug the USB memory device.

DVB-T or DVB-C

If both DVB-T and DVB-C reception is available in your country and if this TV is ready to receive DVB-T and DVB-C for your country, you will have selected one or the other during the channel installation.

If you want to change the DVB setting to start a new channel installation, press **Home** > **Setup** > **Channel settings** and press **OK**. Select **Channel installation** > **Antenna or Cable DVB** and press **OK**. Select the DVB setting you want.

DVB-C channel installation

For ease of use, all DVB-C settings are set to automatic. If your DVB-C provider gave you specific DVB-C values, like a symbol rate or a frequency, enter these values when the TV asks for them during installation.

DVB-T + DVB-C

You can set up your TV for DVB-T and DVB-C. Install one system followed by the other. When both installations are complete, the Channel list will show both DVB-T and DVB-C channels.

Reception quality

If you receive digital channels, you can check the quality and signal strength of a channel.

If you use an antenna, you can reposition the antenna to try and improve the reception.

To check the reception quality of a digital channel, switch to the channel and press **Home** > **Setup** > **Channel settings** and press **OK**. Select **Channel installation** > **Digital : reception test** and press **OK**.

The digital frequency is shown for this channel. If the reception is poor, you can reposition your antenna. To check the signal quality of this frequency again, select **Search** and press **OK**.

To enter a specific digital frequency yourself, select the frequency, position the arrows on a number with **Right** and **Left** and change the number with **Up** and **Down**. To check the frequency, select **Search** and press **OK**.

If you use DVB-C to receive channels, the options **Symbol rate mode** and **Symbol rate** are available. For Symbol rate mode, select **Automatic**, unless your cable provider gave you a specific symbol rate value. To enter the symbol rate value, use the number keys.

Manual installation — Analogue

Analogue TV channels can be manually tuned in channel by channel.

To install analogue channels manually, press **Home** > **Setup** > **Channel settings** and press **OK**. Select **Channel installation** > **Analogue : manual installation** and press **OK**.

1 System

To set up the TV system, select **System** and press **OK**. Select your country or part of the world where you are now.

2 Find channel

To find a channel, select **Find channel** and press **OK**. Select **Search** and press **OK**. You can also enter a frequency yourself. If the reception is poor, press **Search** again. If you want to store the channel, select **Done** and press **OK**.

3 Fine tune

To fine tune a channel, select **Fine tune** and press **OK**. You can fine tune the channel with **Up** or **Down**. If you want to store the channel found, select **Done** and press **OK**.

4 Store

You can store the channel on the current channel number or as a new channel number. Select **Store current channel** or **Store as new channel**.

You can redo these steps until you found all available analogue TV channels.

Clock settings

In some countries, digital broadcasts do not send UTC - Coordinated Universal Time information. The daylight saving change might be ignored and the TV might show an incorrect time.

To correct the TV clock, press **Home** > **Setup** > **TV settings** > **Preferences** > **Clock** and select **Country dependent**. Select **Daylight saving** and select the appropriate setting.

To set the time and date manually, select **Manual**. Then select **Time** or **Date**.

4.4 Network

Benefits

Browse PC

If you connect the TV to a home network, you can play photos, music and videos from your computer or storage device. Once the network is installed on the TV, you can find and play the files from your PC on the TV screen.

Net TV

If you connect the TV to a home network with an Internet connection, you can link up the TV to Net TV. Net TV offers Internet services and websites tailored to your TV. Play music and videos, consult infotainment, rent movies and much more. Once the network is installed, you can enjoy the best of the Internet for your TV.

Interactive TV

With the TV connected to the Internet, you can enjoy the full benefits of Interactive TV. Systems such as HbbTV, MHP, etc use the Internet to communicate with the TV.

Wi-Fi MediaConnect

With Wi-Fi MediaConnect you can bring up (project) your PC screen on the TV screen wirelessly. You start Wi-Fi MediaConnect from your PC.

What you need

To connect the TV to a home network and the Internet, you need a router in your home network. The router must be set to DHCP server on. Use a router with a high-speed (broadband) connection to the Internet. You can connect the TV wirelessly or wired.

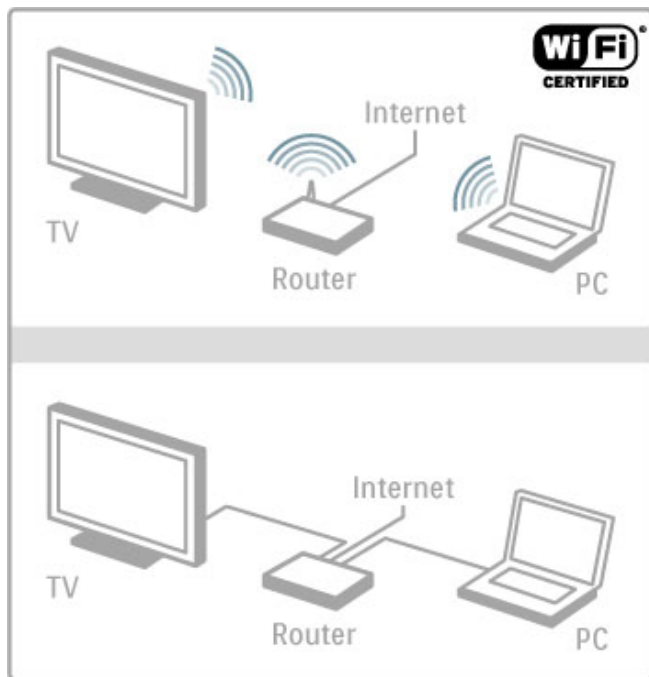

If you use a wired connection to the router you need a network (Ethernet) cable.

The TV uses a DLNA-certified protocol. You can use a computer with Microsoft Windows XP, Vista or Windows 7, Intel Mac OSX or Linux as the operating system.

Find your PC files

To select your PC files on screen, you need recent media server software on your computer, like Windows Media Player 11 or similar. To find your files on the TV, some media server software must be set up to share the PC files with the TV.

Find the list of supported media server software in [Help > Specifications > Multimedia](#).

Wireless installation

Switch on your router before you start the network installation.

To start the wireless network installation, press **▲**, select **Setup > Connect to network** and press **OK**. Follow the instructions on screen.

WPS - Wi-Fi Protected Setup

If your router has WPS (Wi-Fi Protected Setup), go to the router and press the WPS button. Return to the TV within 2 minutes, select **WPS** and press **OK**. The TV connects to your network. This takes about 2 minutes. Finish the installation.

Most new wireless routers have the WPS system and carry the WPS logo. The WPS system uses WPA security encryption and cannot be combined with devices on your network that use the WEP security encryption. If you still need this WEP device in your network, install with [Scan > Standard](#).

Scan for routers

If you have several routers in your network, you can select the network you need. To select a specific network router, press **Scan** on the first page of the installation. The routers with WPS and with the strongest signal are shown first in the list.

Select the router you need and press **WPS** if the router has WPS. Or press **Pin code** if you can enter the PIN code in your router software to connect. Or press **Standard** to enter the encryption key manually.

PIN code

To make the secured connection with a PIN code, select **PIN code** and press **OK**. Write down the 8-digit PIN code shown and enter it in the router software on your PC. See the router manual where to enter the PIN code.

Standard

To enter the encryption key (the security key) manually, select **Standard** and press **OK**. If you have WPA security on your router, enter the passphrase with the remote control. To open the on-screen keyboard, select the text entry field and press **OK**.

If you have WEP security encryption, the TV asks for the WEP encryption key in hexadecimal numbers. Find this hexadecimal key in the router software on your PC. Write down the first key of the WEP keys list and enter it on TV with the remote control. If the security key is accepted, the TV is connected with the wireless router.

If asked, agree to the End User License Agreement.

Wi-Fi Media Connect

With Wi-Fi MediaConnect you can bring up (project) your PC screen on the TV screen wirelessly. With the supplied Wi-Fi MediaConnect CD-ROM you can download the software for free. Wi-Fi MediaConnect is only available for PC.

What you need

To use Wi-Fi MediaConnect, you need to connect the TV to your home network. You need a wireless router.

Read more about connecting to a network in **Help > Setup > Network**.

Install Wi-Fi MediaConnect

1 Insert the Wi-Fi MediaConnect CD-ROM into your PC.

2 Your PC starts your Internet browser and opens the Wi-Fi MediaConnect download page -

www.philips.com/wifimediaconnect. On the website, you can check the necessary PC system requirements.

3 Enter the code printed on the CD-ROM envelope.

4 Click the 'Download now' button to download the free Wi-Fi MediaConnect software.

5 Once downloaded, start the file 'Wi-Fi MediaConnect_setup.exe'. Follow the instructions on screen.

TV network name

If you have more than one TV in your home network, you can rename this TV. To rename this TV in the network, press **⬆** >

Setup > Network settings and select **TV network name**. To enter the name, press **OK** to open the on-screen keyboard or use the remote control keypad.

To use Wi-Fi MediaConnect on your PC read **Help > Smart TV > Videos, photos and music > Wi-Fi MediaConnect**.

PC requirements

Windows XP, Vista, Windows 7 (PC only)

Minimum PC requirements

- Intel® Pentium Core™ 2 Duo 1.8GHz
- 512MB RAM
- 200MB free hard disk space
- Wi-Fi 802.11g
- Broadband Internet connection

Recommended PC requirements

- Intel® Pentium Core™ 2 Duo 2.1GHz
- 1GB RAM
- 200MB free hard disk space
- Wi-Fi 802.11n for router and PC
- Broadband Internet connection

Wired installation

Connect the router to the TV and switch on your router before you start the network installation.

To start the network installation, press **⬆**, select **Setup > Connect to network** and press **OK**. Follow the instructions on screen.

The TV constantly searches for a network connection. The router must be set to DHCP server on.

If asked for, agree to the End User License Agreement.

Read more about how to connect in **Help > Connections > Network > Wired**.

Network settings

To open the Network settings, press **⬆** > **Setup > Network settings** and press **OK**.

You can view the network type, IP and MAC address, the signal strength, speed and encryption method etc. You can set DHCP and Auto IP, the IP configuration settings, DMR and the TV network name.

4.5 Devices

EasyLink HDMI-CEC

With EasyLink HDMI-CEC your TV and the connected devices can work together. You can use the TV remote control to operate EasyLink devices. The device needs to be connected with an HDMI cable. Devices with EasyLink appear automatically in the Home menu.

Setup

The TV comes with EasyLink switched on.

Make sure that all HDMI-CEC settings are properly set up on the connected EasyLink devices. EasyLink might not work with devices from other brands.

Switch off EasyLink RC

If you don't want to operate devices with the TV remote control, you can switch off EasyLink remote control separately. Press Home  > **Setup** > **TV settings** and select **EasyLink** > **EasyLink Remote Control** and select **Off**.

Switch off EasyLink

To switch off EasyLink completely, press Home  > **Setup** > **TV settings** and select **EasyLink** > **EasyLink On/Off** and select **Off**.

HDMI-CEC on other brands

The HDMI-CEC functionality has different names on different brands. Some examples are: Anynet, Aquos Link, Bravia Theatre Sync, Kuro Link, Simplink and Viera Link. Not all brands are fully compatible with EasyLink.

Read more about using EasyLink in **Help** > **Basics** > **Remote control** > **Operate devices**.

Add a new device

Devices connected with EasyLink HDMI-CEC automatically show their activity in the Home menu. A single device can add several activities. The device must be connected with an HDMI cable. If your connected device does not appear in the Home menu, on the device EasyLink may be switched off.

If your connected device does not have EasyLink or is not connected with an HDMI cable, you need to manually add your device with **Add your devices** in the Home menu.

Add your devices

In the Home menu, select **Add your devices** and press **OK**.

Follow the instructions on screen.

The TV asks you to select the device and the connection to which the device is connected.

The device or its activities are now added to the Home menu.

Rename a device

To rename a device in the Home menu, select the device and press  **OPTIONS** and select **Rename**. Use the keypad on the remote control as you do for SMS/text messaging to enter the new name or press **OK** to open the on-screen keyboard.

Delete a device

To delete a device or activity from the Home menu, select the item and press  **OPTIONS** and then select **Remove this device**.

If the device or activity, keeps appearing in the Home menu after you deleted it, switch off the EasyLink setting on the device to prevent the icon from being automatically added again.

Audio to Video sync

With a Home Theatre System (HTS) connected to the TV, the picture on TV and the sound from the HTS should be synchronised. A mismatch can be visible in scenes with people talking. When they finish sentences before their lips stop moving.

Automatic audio to video sync

With recent Philips Home Theatre Systems, the audio to video sync is automatically synchronised and always correct.

Audio sync delay

Other Home Theatre Systems might need to adjust the audio sync delay to synchronise the audio to video. On the HTS, increase the delay value until there is a match between picture and sound. A delay value of 180ms may be required. Read the user manual of the HTS.

With a delay value set up on the HTS, you need to switch off **Audio Out delay** on the TV if the HTS sets an identical delay for all its incoming audio. To switch off Audio Out delay, press  and select **Setup** > **TV settings** > **Preferences** > **Audio Out delay**. Select **Off** and press **OK**.

If you cannot set up a delay on the HTS or its maximum setting is insufficient, you can switch off the Perfect Natural Motion picture processing of the TV. To switch off Perfect Natural Motion, press  and select **TV settings** > **Picture** > **Perfect Natural Motion**. Select **Off** and press **OK**.

Auto subtitle shift

If you play a DVD or Blu-ray Disc on a recent Philips player, the TV can move the subtitles upwards. Subtitles will then be visible whatever Picture format you select. The TV comes with Auto subtitle shift switched on.

To switch off Auto subtitle shift, press  > **Setup** > **TV settings** > **EasyLink** > **Auto subtitle shift**. Select **Off**.

Pixel Plus link

Some other devices, DVD or Blu-ray Disc players, might have their own picture quality processing. To avoid bad picture quality caused by interference with the TV processing, the picture processing of these devices should be disabled. The TV comes with Pixel Plus link switched on and disables the picture quality processing of recent Philips devices connected to the TV.

To switch off Pixel Plus link, press  > **Setup** > **TV settings** > **EasyLink** > **Pixel Plus link**. Select **Off**.

4.6 Universal access

Switch on

With Universal access switched on, the TV is set for use for hearing and visually impaired people.

Switch on

If you did not switch on Universal access during the installation, you can still switch it on in Setup.

To switch on Universal access, press **▲** > **Setup** > **TV settings** > **Preferences** > **Universal access**. Select **On** and press **OK**.

With Universal access switched on in Setup, the Universal access option is added in the Options menu. With Universal menu in the Options menu, you can set specific settings for hearing and visually impaired people.

Hearing impaired

Some digital TV channels broadcast special audio and subtitles adapted for hearing impaired people. With Hearing impaired switched on, the TV automatically switches to the adapted audio and subtitles, if available.

Switch on

To switch on Hearing impaired, press **≡** **OPTIONS**, select **Universal access** and press **OK**. Select **Hearing impaired**, select **On** and press **OK**.

To check whether a hearing impaired audio language is available, press **≡** **OPTIONS**, select **Audio language** and look for an audio language marked with a .

If Universal access does not appear in the Options menu, switch on Universal access in the Setup. Read **Help** > **Setup** > **Universal access** > **Switch on**.

Visually impaired

Some digital TV channels broadcast special audio called Audio Description for visually impaired people. The audio consists of a narrator describing what is happening in the programme during the pauses in the normal audio.

Switch on

To switch this visually impaired audio, press **≡** **OPTIONS**, select **Universal access** and press **OK**. Select **Visually impaired** and select **On** or, if available, select the speakers the adapted audio should be played from. If available, the TV will play the visually impaired audio.

Volume - Visually impaired

If available, you can set the volume of the extra commentary.

To check whether a visually impaired audio language is available, press **≡** **OPTIONS**, select **Audio language** and look for an audio language marked with a .

If Universal access does not appear in the Options menu, switch on Universal access in the Setup. Read **Help** > **Setup** > **Universal access** > **Switch on**.

Key beep

Key beep gives an audio feedback each time you press a key on the remote control. The volume of the beep is fixed.

Switch on

To switch on Key beep, press **≡** **OPTIONS**, select **Universal access** and press **OK**. Select **Key beep** and select **On**.

If Universal access does not appear in the Options menu, switch on Universal access in the Setup. Read **Help** > **Setup** > **Universal access** > **Switch on**.

4.7 Software

Current version

To view the current TV software version, press **⬆** > **Setup** > **Software settings** and press **OK**. Select **Current software info** and read **Version**:

Update from Internet

If the TV is connected to the Internet, you may receive a message from Philips to update the TV software. You need a high-speed (broadband) Internet connection.

If you receive this message, we recommend you carry out the update. Select **Update**. Follow the instructions on screen.

You can also look for new updates yourself. To look for an update, press **⬆** > **Setup** > **Update software** and press **OK**. Follow the instructions on screen.

When the update is complete, the TV switches off and back on again automatically. Wait for the TV to switch itself back on. Do not use the Power switch **⏻** on the TV.

Update with USB

It might be necessary to update the TV software. You need a PC with an high-speed Internet connection and a USB memory device to upload the software on the TV. Use a USB memory device with 256MB free space. Make sure that write protection is switched off.

- 1 Start
- 2 Identify
- 3 Download
- 4 Update TV

1 Start the update on TV

To start the software update, press **⬆** > **Setup** > **Update software**. Select **USB**.

2 Identify the TV

Insert the USB memory into the side of the TV, select **Start** and press **OK**. An identification file is written on the USB memory device.

3 Download the TV software

Insert the USB memory into your PC. On the USB memory device, locate the file **update.htm** and double click it. Click on **Send ID**. If new software is available, download the .zip file. After the download, unzip the file and copy the file **autorun.upg** onto the USB memory device. Do not place this file in a folder.

4 Update the TV software

Insert the USB memory into the TV again. The update starts automatically. The TV switches itself off for 10 seconds and then back on again. Please wait.

Do not . . .

- use the remote control
- remove the USB memory device from the TV

If a power cut occurs during the update, never remove the USB memory device from the TV. When the power returns, the update will continue.

At the end of the update, the message **Operation successful** appears on screen. Remove the USB memory device and press **⏻** on the remote control.

Do not . . .

- press **⏻** twice
 - use the **⏻** switch on the TV
- The TV switches itself off (for 10 seconds) and then back on again. Please wait.

The TV software has been updated. You can use the TV again.

To prevent an accidental update of the TV software, delete the **autorun.upg** file from the USB memory device.

5 Connections

5.1 First connections

Power cable

Insert the power cable into the power socket of the TV.

When disconnecting the power cable, always pull the plug, never the cable.

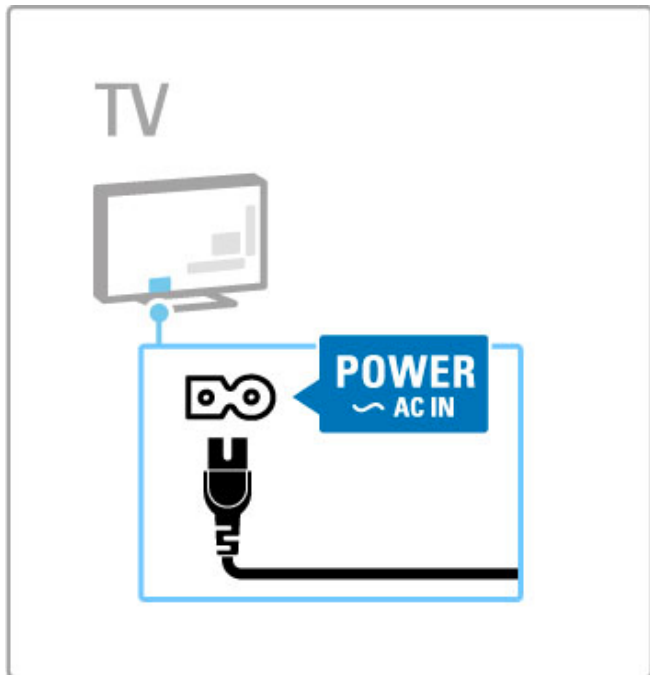

Although this TV has a very low standby power consumption, switch off the TV with the power switch to save energy if you do not use the TV for a long period of time. Read more about the power switch in [Help > Getting started > Keys on the TV > Power switch](#).

Make sure the power cable is securely inserted into the TV. Make sure that the power plug in the wall socket is accessible at all times.

Antenna cable

Locate the antenna connection at the back of the TV. Insert the antenna cable securely into the **Antenna**  socket.

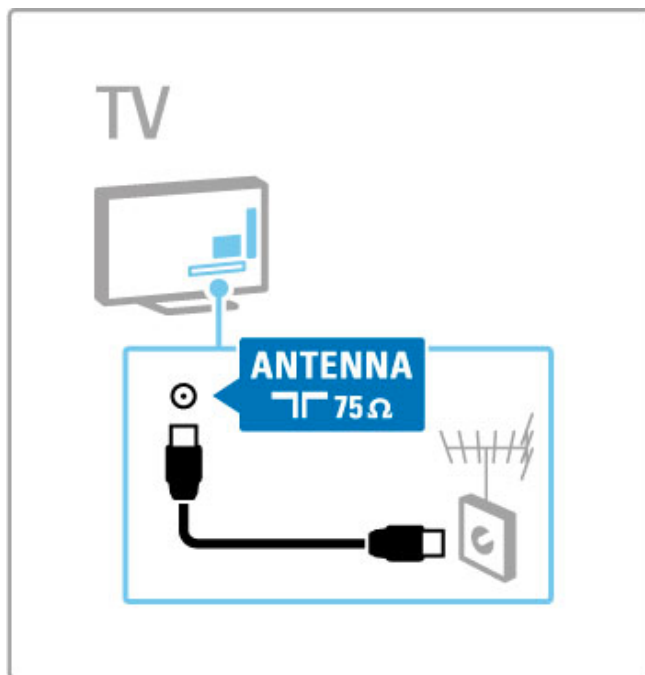

5.2 Cables and connections

Cable quality

Before you connect devices to the TV, check which connectors are available on the device. Connect the device to the TV with the highest quality connection available. Good quality cables ensure a good transfer of picture and sound. Read the other chapters of **Cables and connections**.

The connections diagrams shown in **Help > Connections > Connect devices** are recommendations. Other solutions are possible.

Visit the Philips support webpages - www.philips.com/support - and start the **Connectivity guide** for TV. The guide can help you to connect the devices you have at home.

HDMI

An HDMI connection has the best picture and sound quality. One HDMI cable combines video and audio signals. Use an HDMI cable for High Definition (HD) TV signals. An HDMI cable transfers picture and sound signals in only one direction (except for the HDMI ARC). Do not use an HDMI cable longer than 5 m.

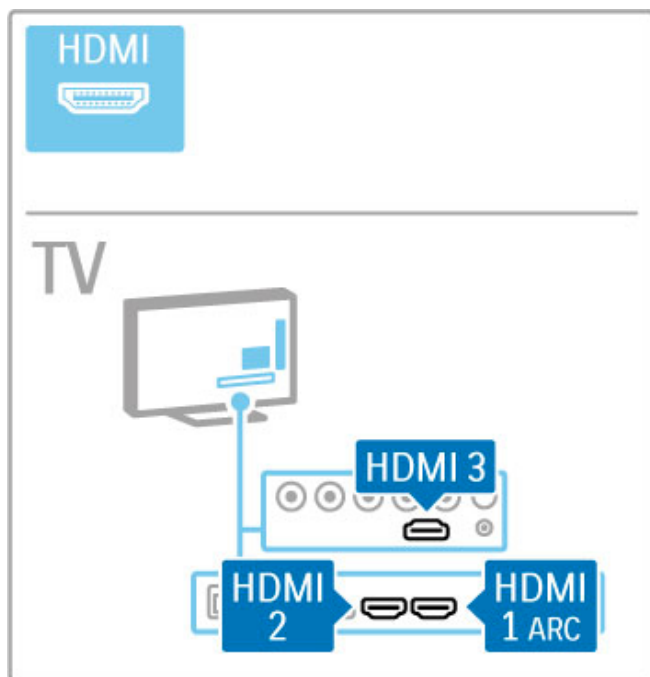

EasyLink HDMI-CEC

If your devices are connected with HDMI and have EasyLink, you can operate them with the TV remote control. Read more about EasyLink in **Help > Basics > Remote control > Operate devices**.

HDMI ARC connection

Connect a Home Theatre System to the HDMI ARC connection. With HDMI ARC, the extra audio cable from the TV to the HTS is not necessary. With one HDMI cable connected to HDMI ARC (Audio Return Channel) both cables are combined.

Switch off HDMI ARC

In case you would like to switch off the audio return signal on the HDMI ARC connection, press **Home** > **Setup** > **TV settings** > **EasyLink** > **HDMI 1 ARC**, select **Off** and press **OK**.

DVI to HDMI

Use a DVI to HDMI adapter if your device only has a DVI connection. Use one of the HDMI connections and add an Audio L/R cable (mini-jack 3.5 mm) to **Audio In DVI/VGA** for sound, on the back of the TV.

Copy protection

DVI and HDMI cables support HDCP (High-bandwidth Digital Contents Protection). HDCP is a copy protection signal that prevents copying content from a DVD disc or Blu-ray Disc. Also referred to as DRM (Digital Rights Management).

Y Pb Pr

Use the Component Video YPbPr connection together with an Audio Left and Right connection for sound.

Match the YPbPr connector colours with the cable plugs when you connect. YPbPr can handle High Definition (HD) TV signals.

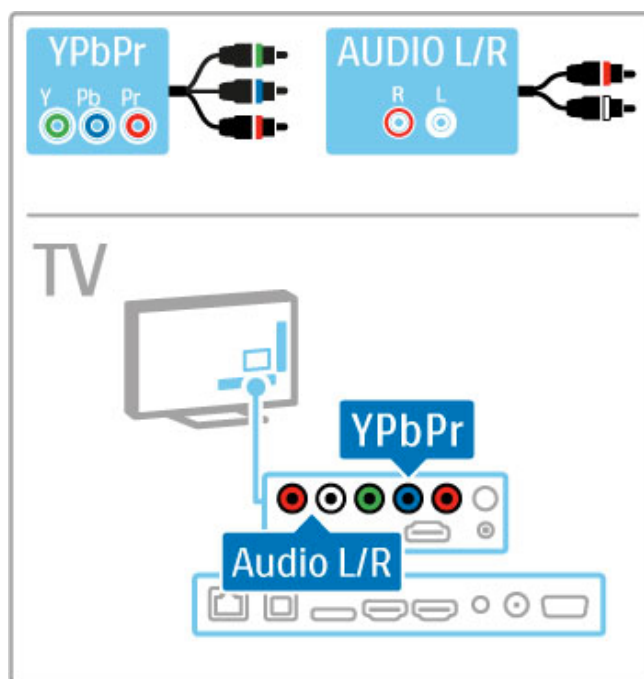

SCART

A SCART cable combines video and audio signals. SCART connectors can handle RGB video signals but cannot handle High Definition (HD) TV signals. Use the included Scart adapter to connect a Scart cable.

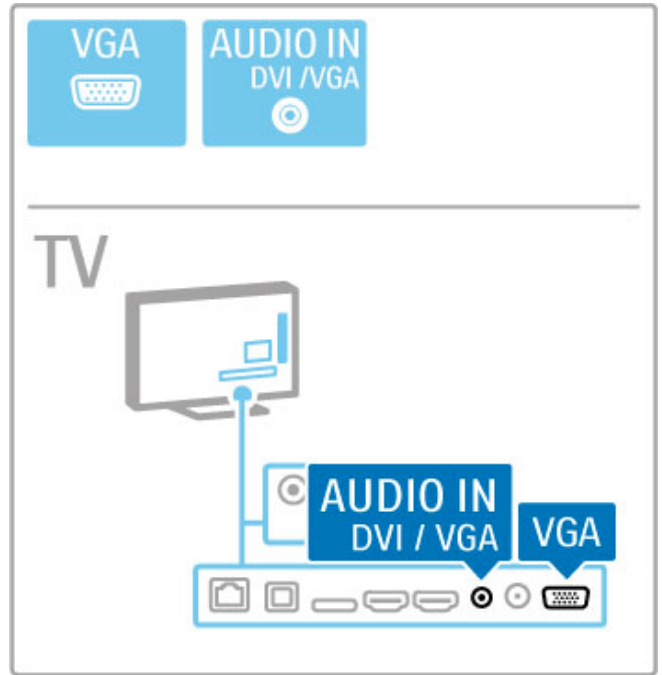
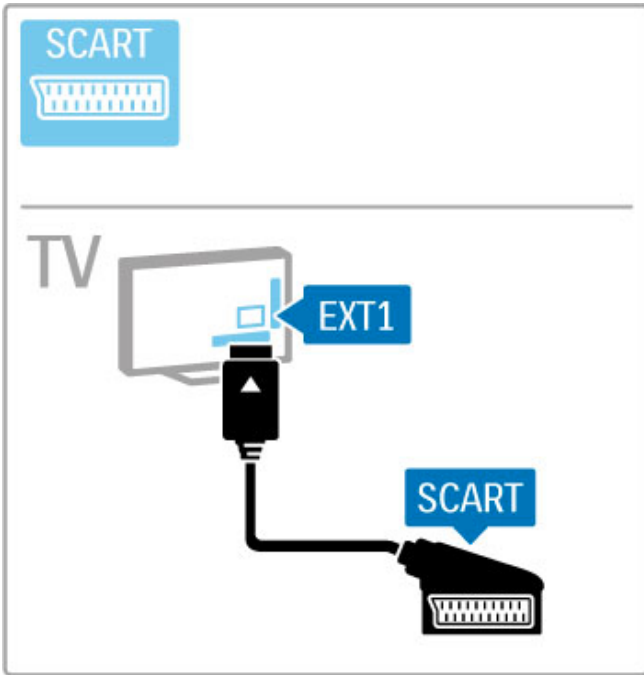

Video

If you have a device with only a Video (CVBS) connection, you need to use a **Video to SCART adapter** (not supplied). Connect the Video to Scart adapter to the included Scart adapter of the TV. You can add the Audio L/R connections.

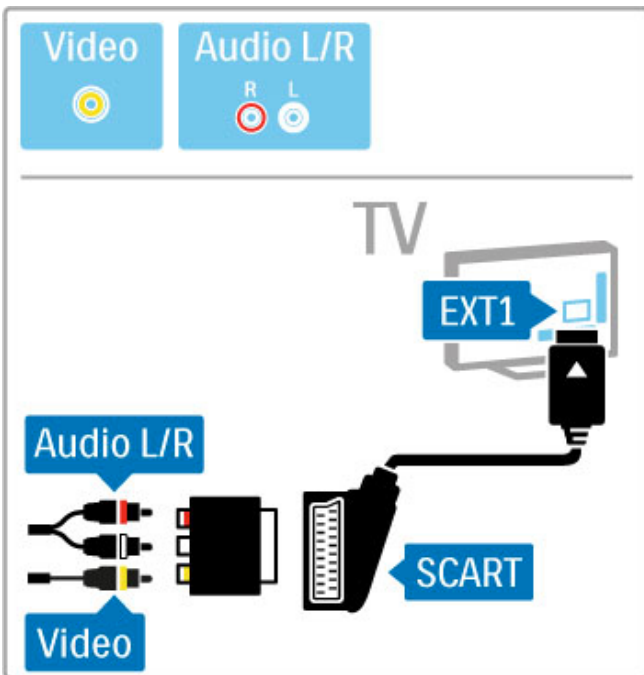

VGA

Use a VGA cable (DE15 connector) to connect a computer to the TV. With this connection you can use the TV as a computer monitor. You can add an Audio L/R cable for sound (mini-jack 3.5 mm).

To connect a computer with the VGA connection, read [Help > Connections > Connect more devices > TV as PC monitor](#).

5.3 Connect devices

SoundBar

Use an HDMI cable to connect the device to the TV.

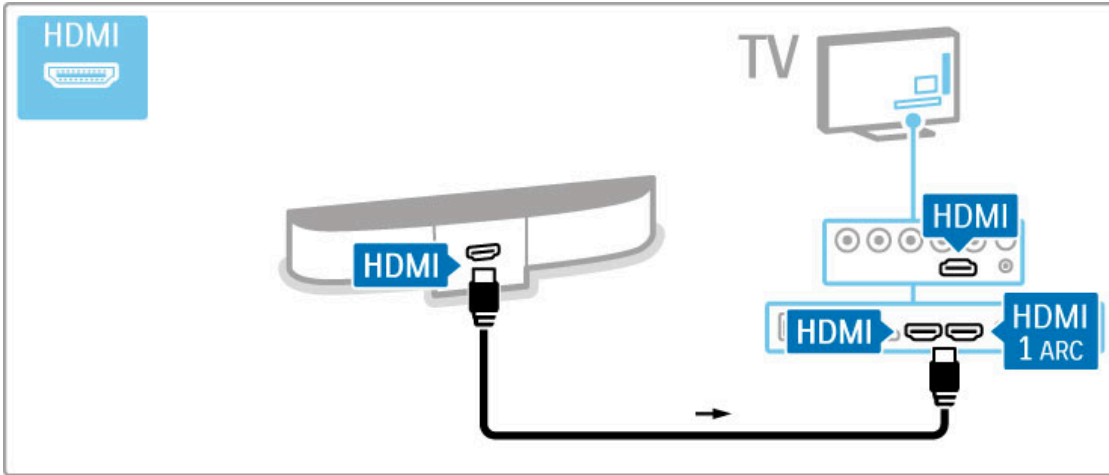

If you use the HDMI-ARC connections on both TV and device, no other cable is needed. If not, read on.

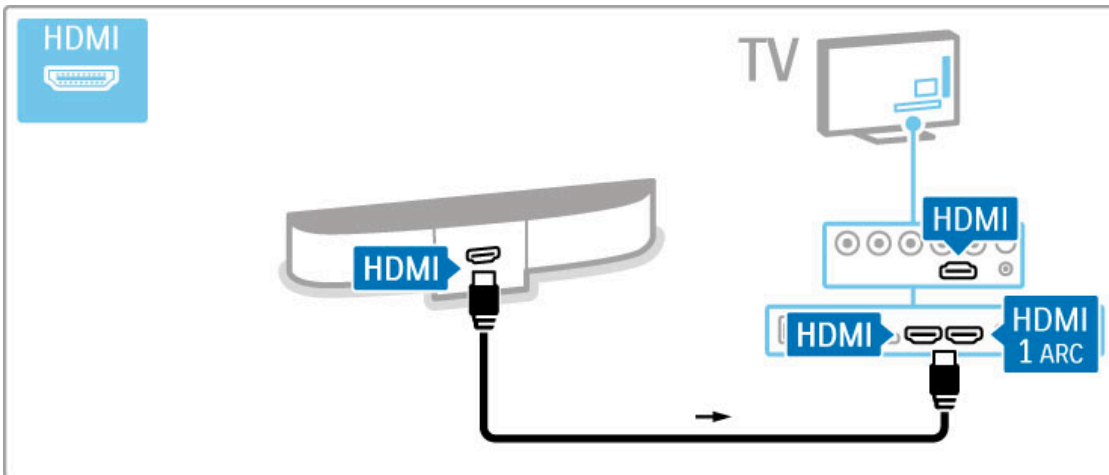

If you do not use the HDMI-ARC connection, add a digital audio cable (optical).

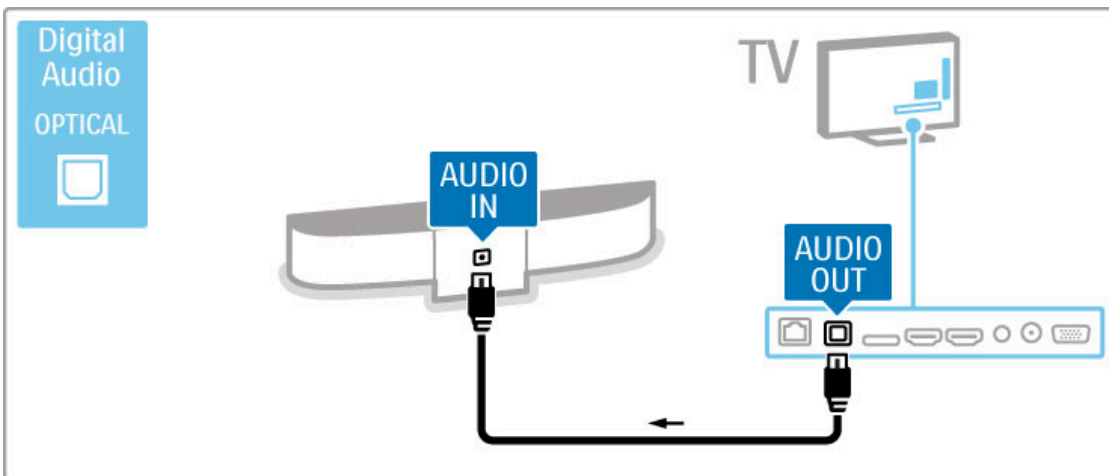

Blu-ray Disc / DVD player

Use an HDMI cable to connect the device to the TV.

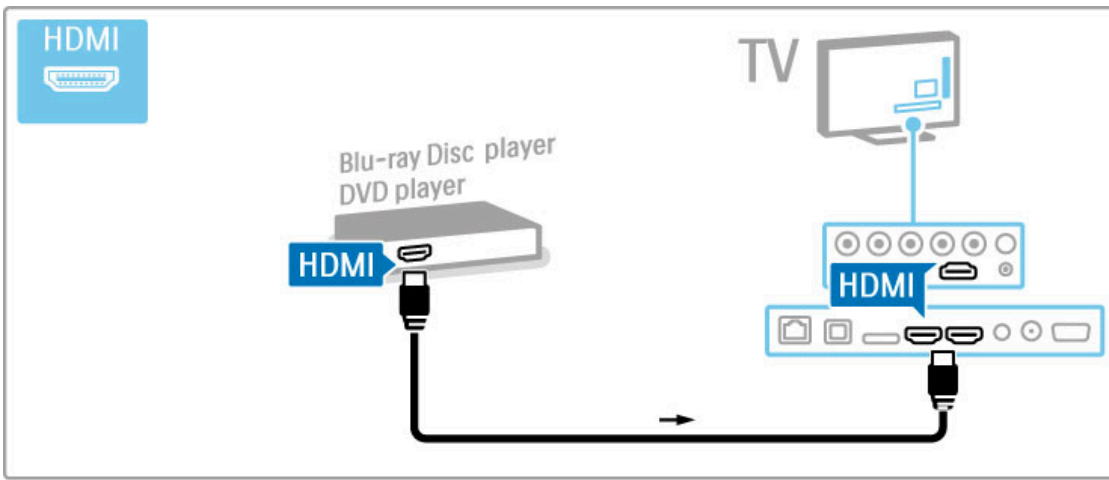

Home Theatre System with disc player

Use an HDMI cable to connect the device to the TV.

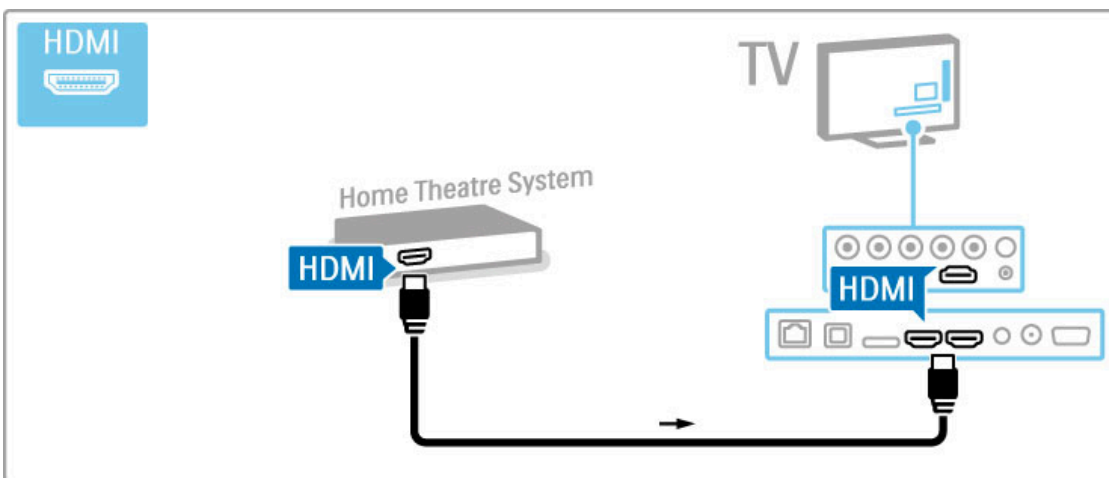

If you use the HDMI-ARC connections on both TV and device, no other cable is needed. If not, read on.

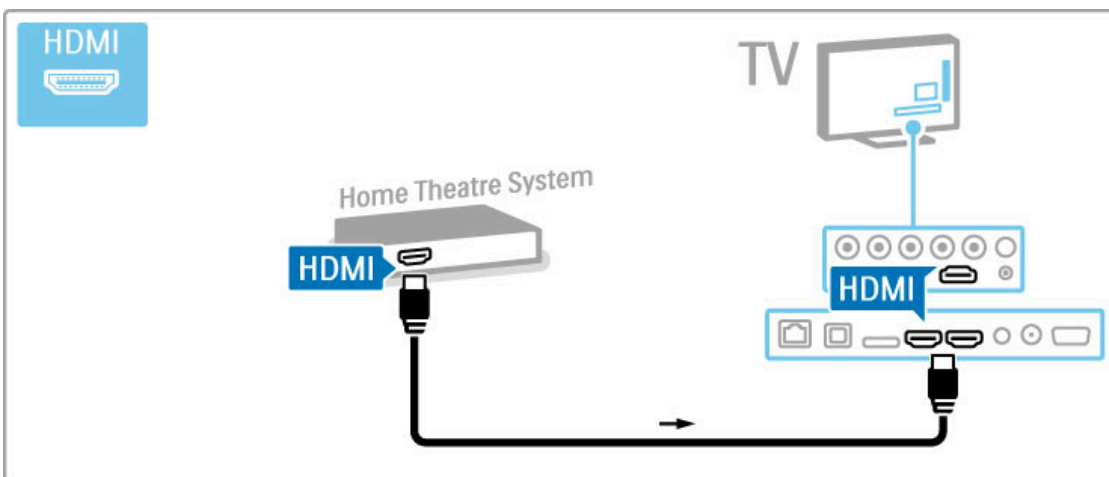

If you do not use the HDMI-ARC connection, add a digital audio cable (optical).

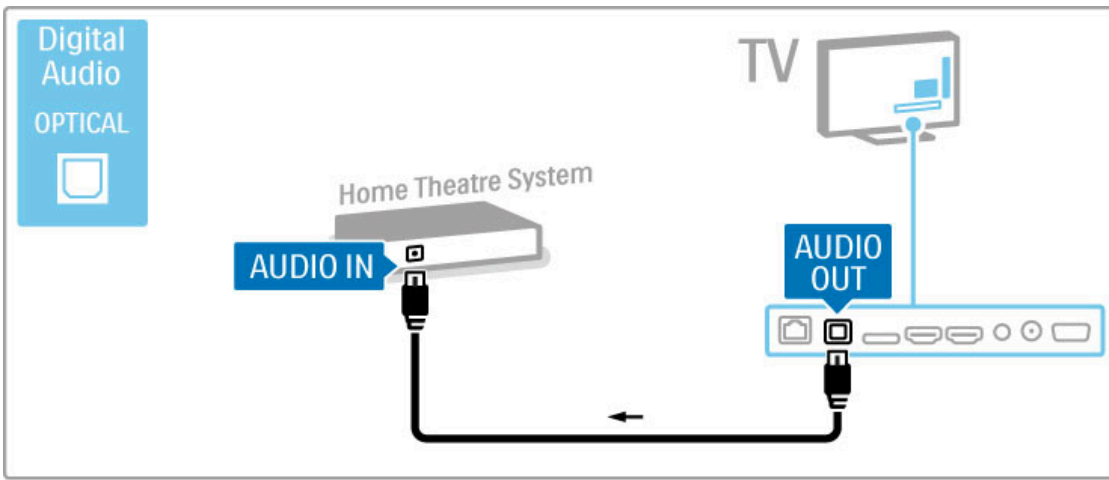

Audio to Video synchronisation (sync)

If the sound does not match with the video on screen, you can set a delay on most DVD Home Theatre Systems to match the sound and video.

Read more about Audio to Video sync in **Help > Setup > Devices > Audio to Video sync**.

Do not connect the audio signal from a DVD player or other device directly to the Home Theatre System. Always route the sound through the TV first.

Recorder

Use 2 antenna cables to connect the antenna to the device and the TV.

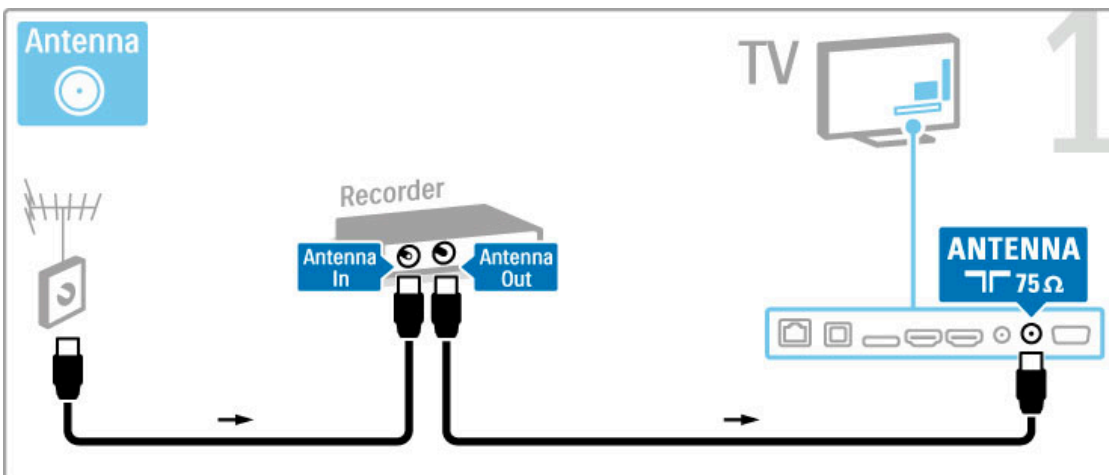

Add an HDMI cable to connect the device to the TV.

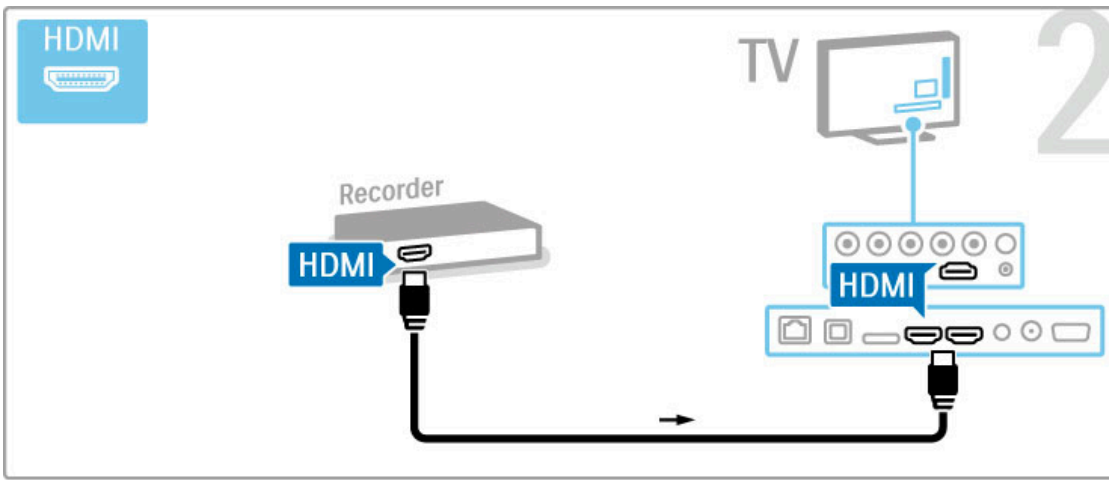

Digital receiver / Satellite receiver

If you use a digital receiver to watch TV (a set top box - STB) and you do not use the remote control of the TV, then switch off the automatic switch off. This will prevent the TV from switching off automatically after a 4 hour period without a key press on the remote control of the TV.

To switch off the automatic switch off, press the **green** key while you are watching TV channels and select **Auto switch off** and select **Off**.

Use 2 antenna cables to connect the antenna to the device and the TV.

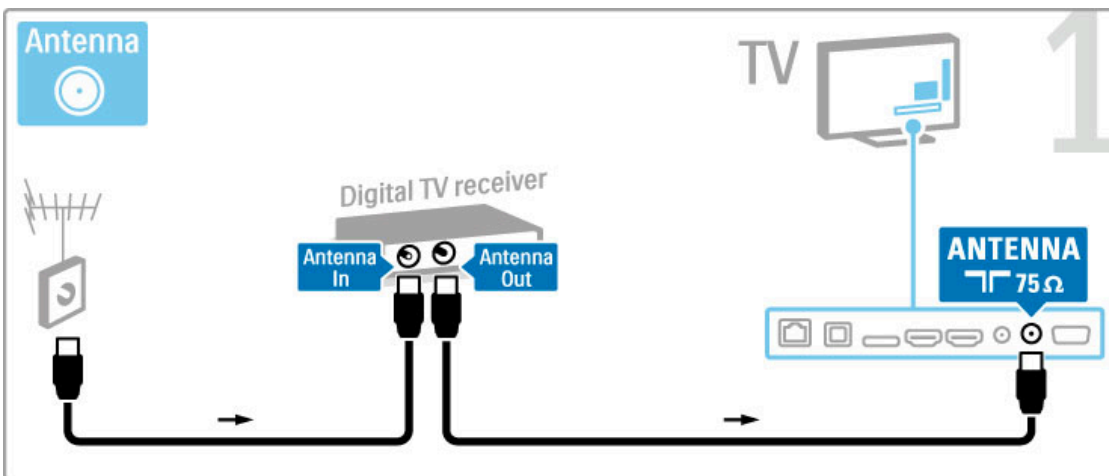

Add an HDMI cable to connect the device to the TV.

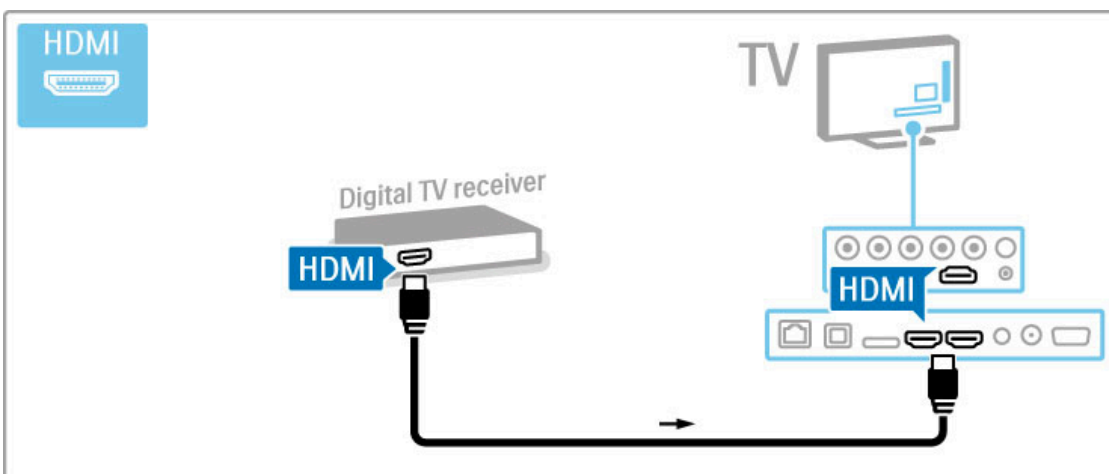

Dig. receiver + Disc Recorder

If you use a digital receiver to watch TV (a set top box - STB) and you do not use the remote control of the TV, then switch off the automatic switch off. This will prevent the TV from switching off automatically after a 4 hour period without a key press on the remote control of the TV.

To switch off the automatic switch off, press the **green** key while you are watching TV channels and select **Auto switch off** and select **Off**.

First, use 3 antenna cables to connect the devices to the TV.

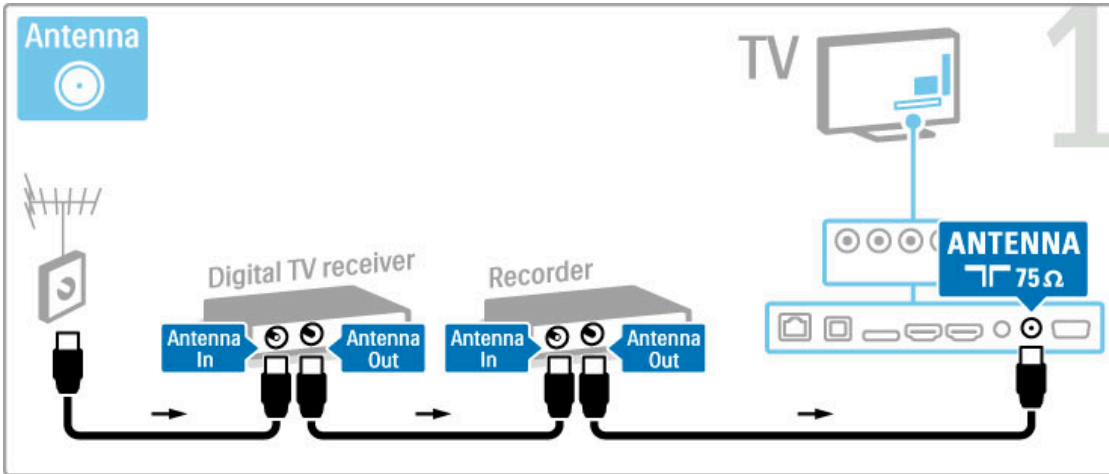

Then use an HDMI cable to connect the digital receiver to the TV.

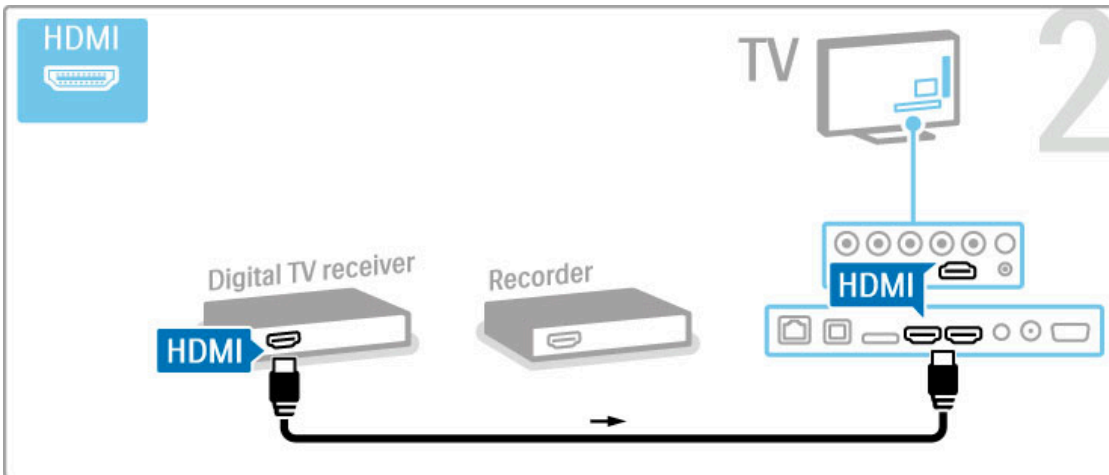

Finally, use an HDMI cable to connect the Disc Recorder to the TV.

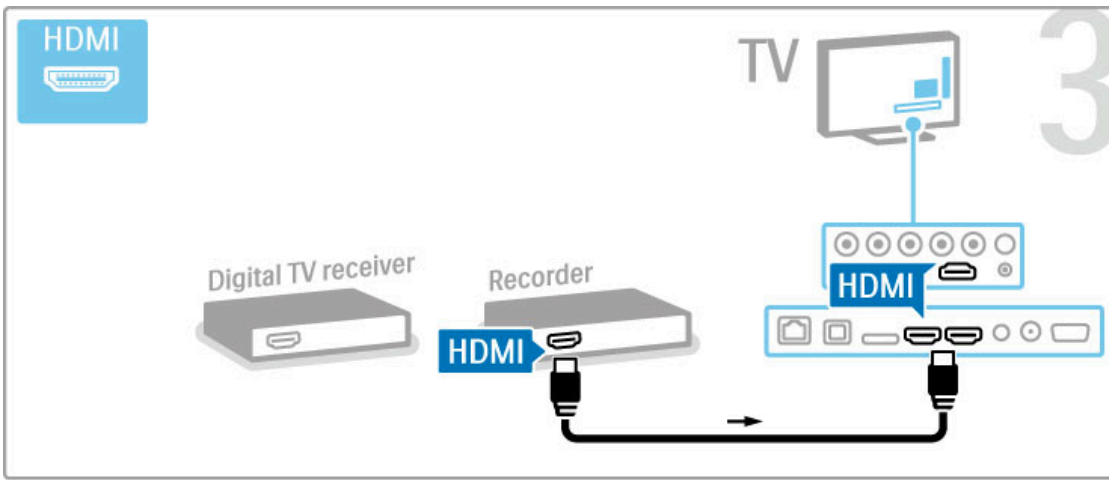

Dig. receiver + Disc-R + Home Theatre

If you use a digital receiver to watch TV (a set top box - STB) and you do not use the remote control of the TV, then switch off the automatic switch off. This will prevent the TV from switching off automatically after a 4 hour period without a key press on the remote control of the TV.

To switch off the automatic switch off, press the **green** key while you are watching TV channels and select **Auto switch off** and select **Off**.

First, use 3 antenna cables to connect the devices to the TV.

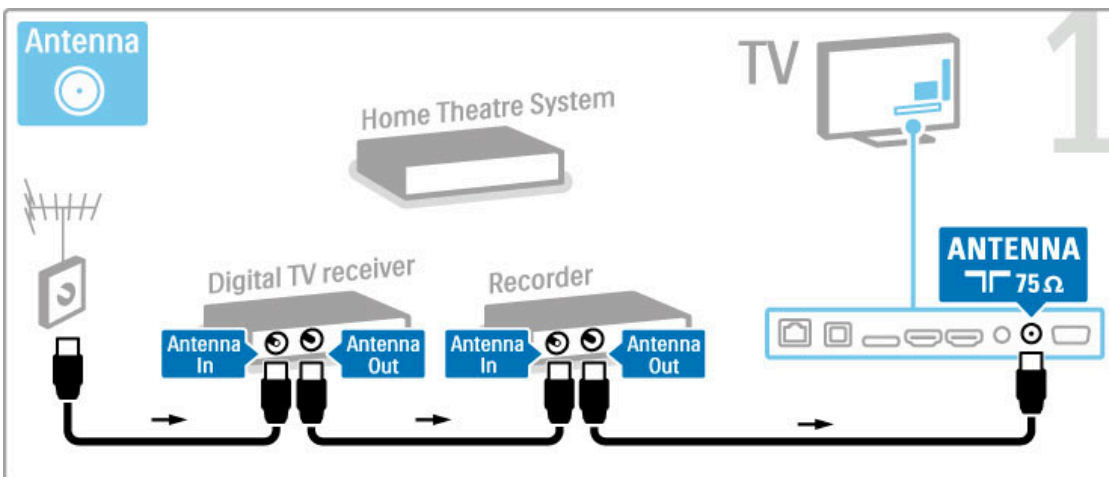

Then use an HDMI cable to connect the digital receiver to the TV.

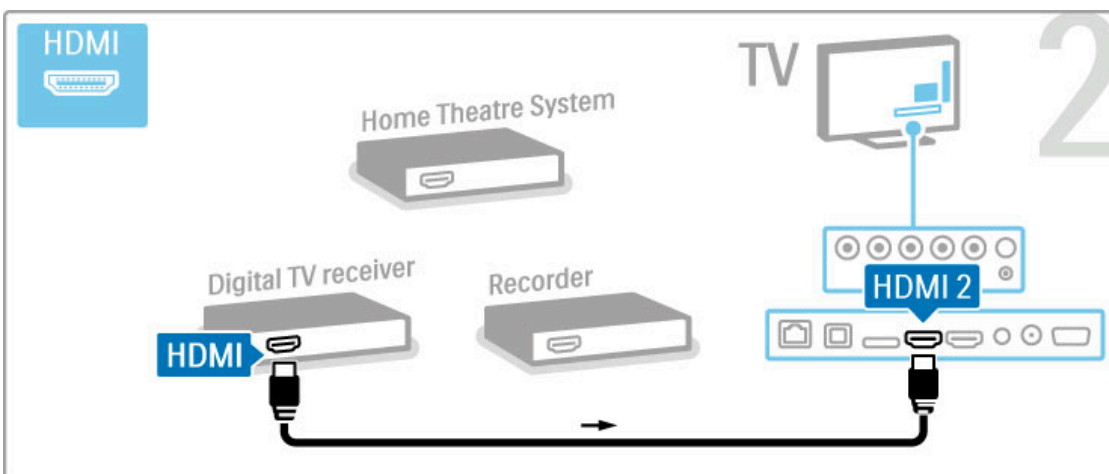

Then use an HDMI cable to connect the Disc Recorder to the TV.

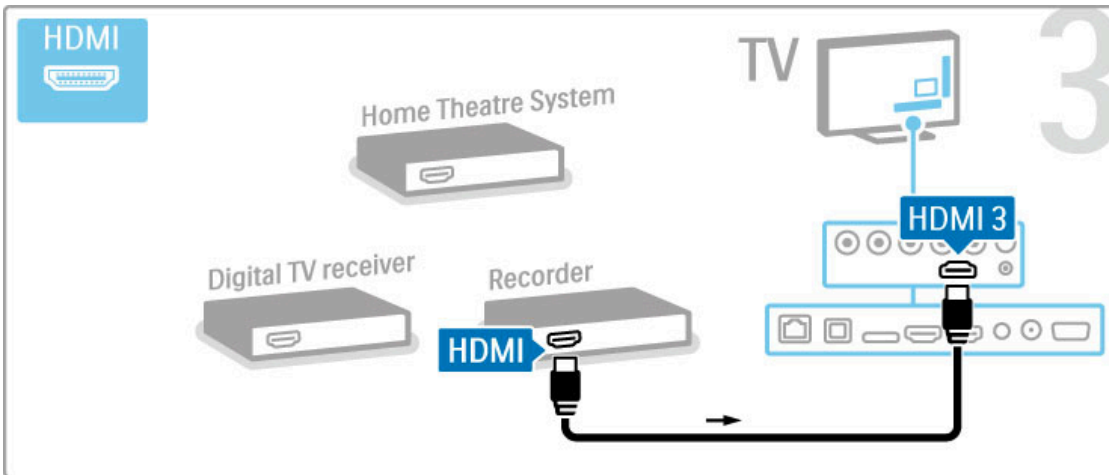

Then use an HDMI cable to connect the Home Theatre System to the TV.

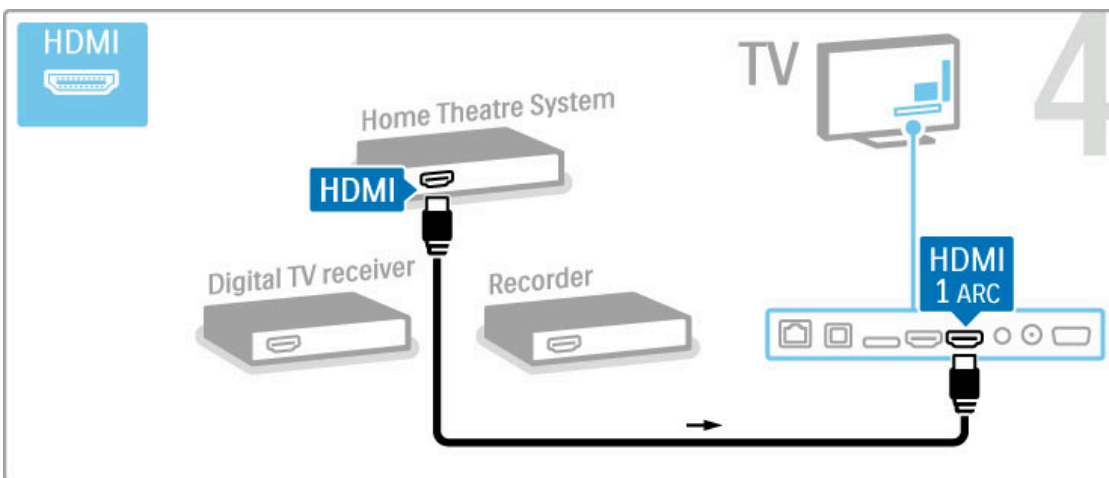

If you do not use the HDMI-ARC connection on the TV and the device, add a digital audio cable (cinch coaxial).

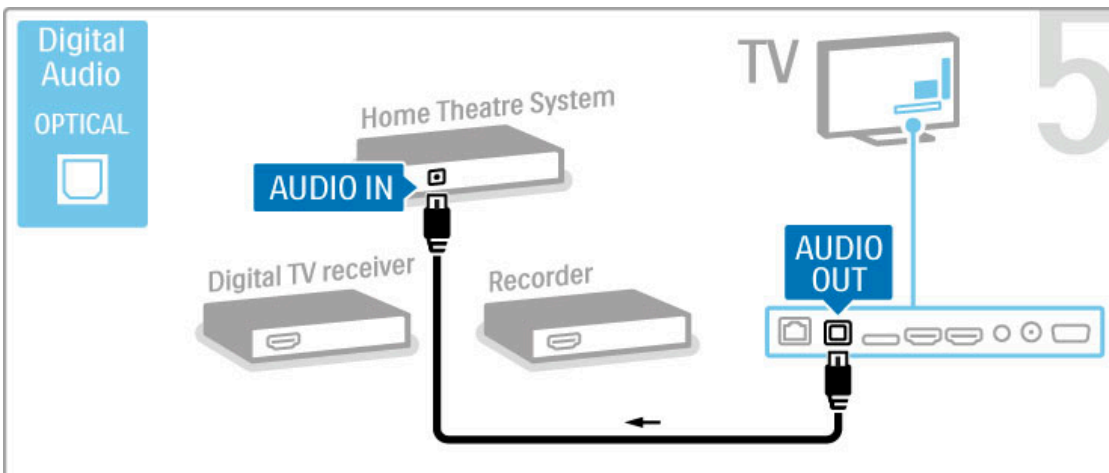

Digital HD receiver

If you use a digital receiver to watch TV (a set top box - STB) and you do not use the remote control of the TV, then switch off the automatic switch off. This will prevent the TV from switching off automatically after a 4 hour period without a key press on the remote control of the TV.

To switch off the automatic switch off, press the **green** key while you are watching TV channels and select **Auto switch off** and select **Off**.

First, use 2 antenna cables to connect the device to the TV.

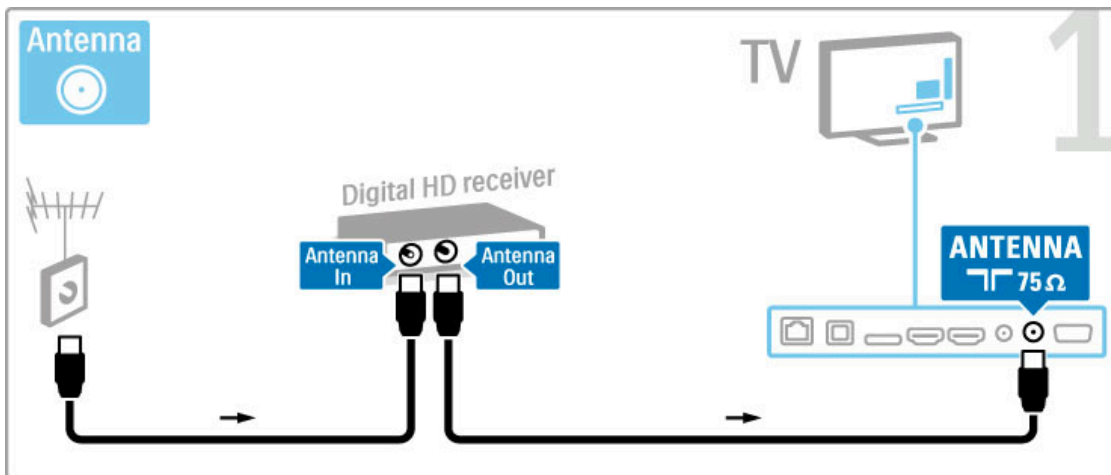

Use an HDMI cable to connect the device to the TV.

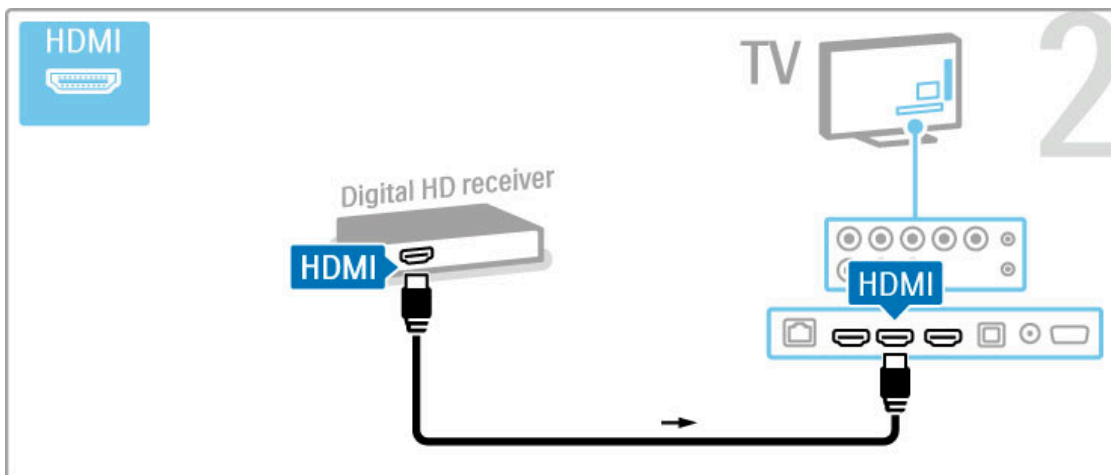

5.4 Connect more devices

Game

Connect a game console to the side or back of the TV. You can use an HDMI, YPbPr or SCART connection. If your game console only has Video (CVBS) and Audio L/R output, use a **Video Audio L/R to SCART** adapter to connect to the SCART connection.

Read more about Games in **Help > Smart TV > Games**.

Use an HDMI cable to connect the device to the side of the TV.

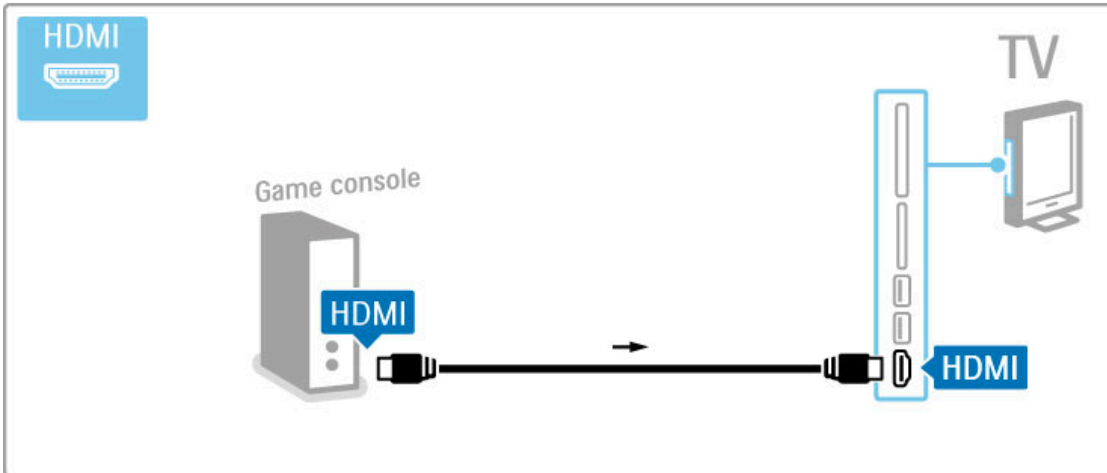

Or use a SCART adapter to connect the device to the TV.

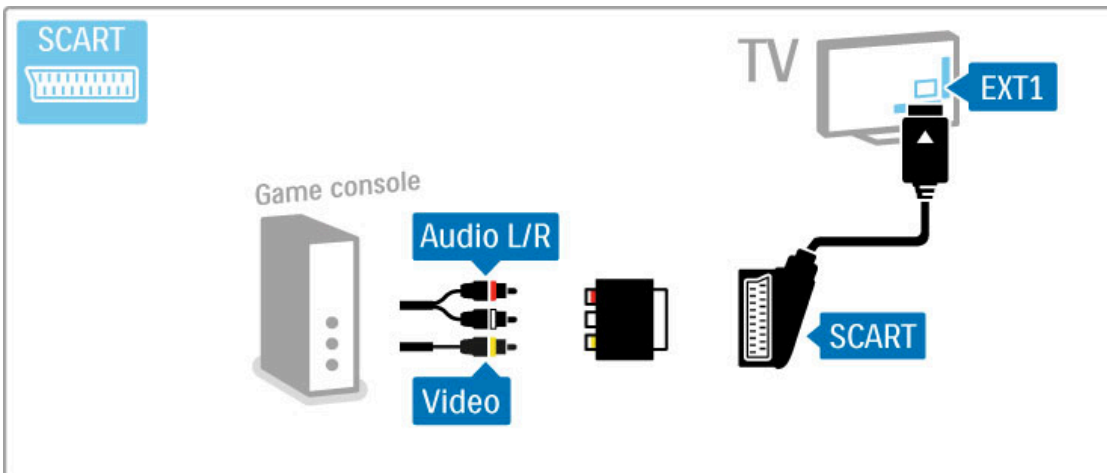

HD Game

Use an HDMI cable or YPbPr and Audio L/R cables to connect a High Definition game console to the TV.

To connect a HD Game console, read **Help > Connections > Connect more devices > Game**.

Photo camera

To view photos stored on your digital photo camera, you can connect the camera directly to the TV. Use the USB connection on the side of the TV to connect. Switch on the camera after you made the connection.

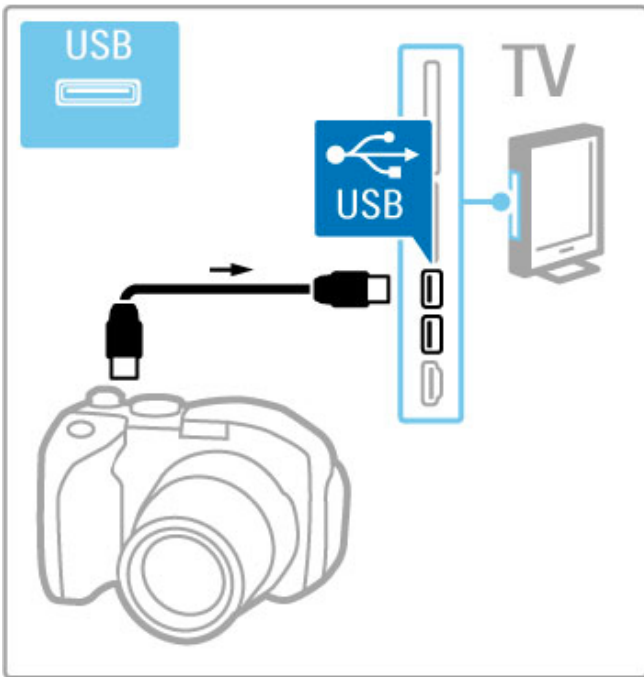

If the list with the content of the camera does not appear automatically, your camera might need to be set to transfer its content with PTP (Picture Transfer Protocol). Read the user manual of the digital photo camera.

Camcorder

Connect a camcorder to the side or back of the TV. You can use an HDMI, YPbPr or SCART connection. If your camcorder only has Video (CVBS) and Audio L/R output, use a **Video Audio L/R to SCART** adapter to connect to the SCART connection.

See the following pages to connect your camcorder.

Use an HDMI cable to connect the camcorder to the side of the TV.

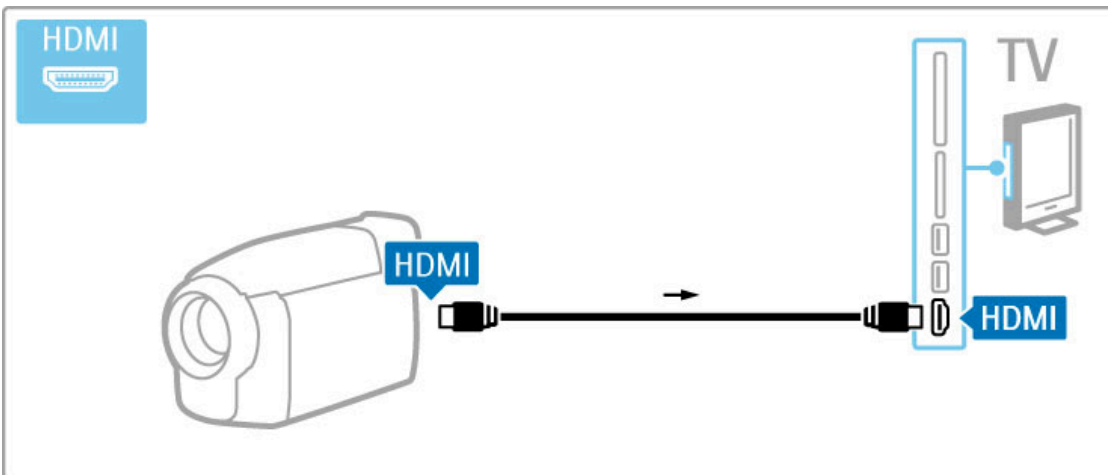

Or use a SCART adapter to connect the device to the TV.

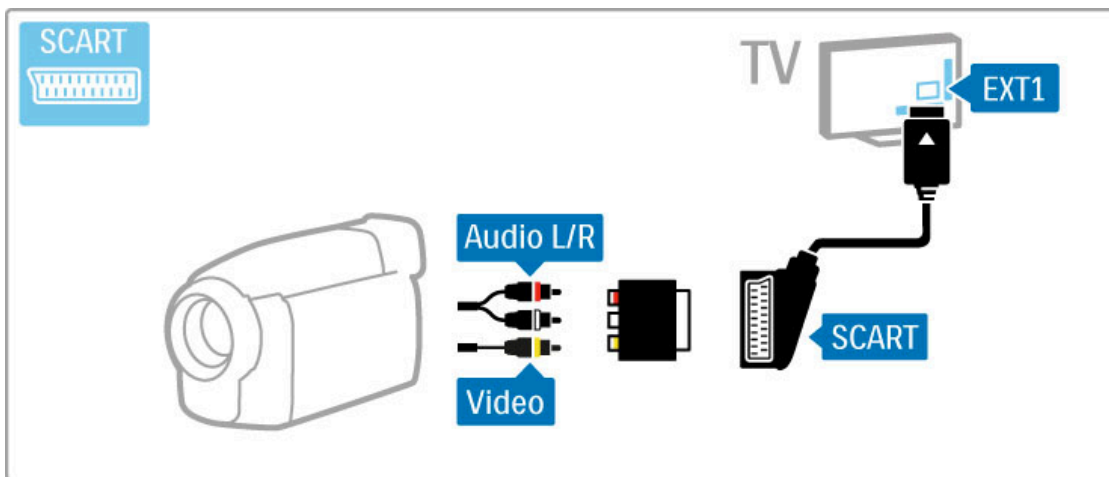

Keyboard and mouse

USB keyboard

You can connect a USB keyboard to enter text on your TV. With a keyboard connected, you can type in a new channel name or type in what you are looking for in the YouTube app in Net TV.

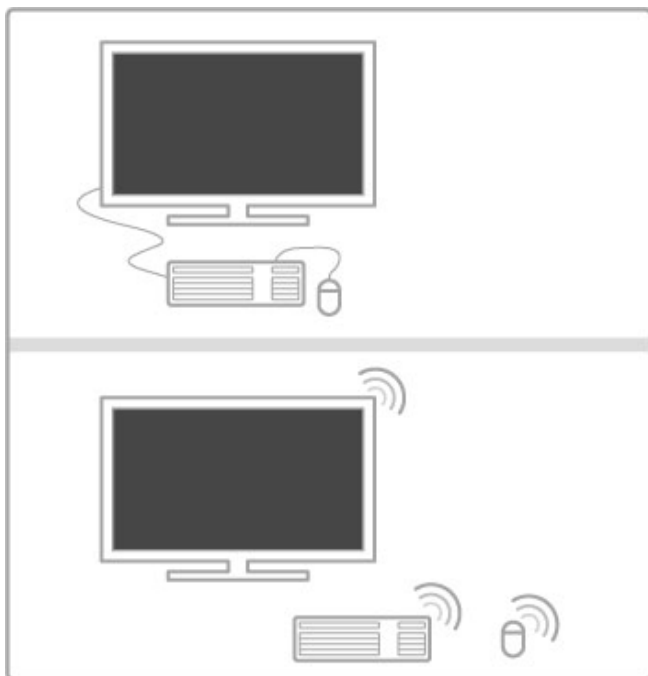

Install

Switch the TV on and connect the USB keyboard to one of the USB connections on the side of the TV. When the TV detects the keyboard, you can select your keyboard lay-out and test your selection.

If you select a Cyrillic or Greek keyboard lay-out first, you can select a secondary Latin keyboard lay-out.

To change the keyboard lay-out setting, press **Home** > **Setup** > **TV settings** > **Preferences** > **USB mouse and keyboard** > **Keyboard settings** and press **OK**.

TV keys on your keyboard

For channel renaming . . .

- Enter **↵** = OK
- Backspace **←** = delete character before cursor
- Navigation keys = navigate within a text field
- To switch between keyboard lay-outs, if a secondary lay-out is set, press the **Alt** + **Shift** keys simultaneously.

For use with Net TV . . .

- **Tab** and **Shift Tab** = Next and Previous
- **Home** = scroll to the top of the page
- **End** = scroll to the bottom of the page
- **Page Up** = jump one page up
- **Page Down** = jump one page down
- + = zoom in one step
- - = zoom out one step
- * = fit to width

USB mouse

You can connect a USB mouse to navigate pages on the Internet. On an Internet page, you can select and click on links more easily. The USB mouse cannot navigate in Net TV app pages nor navigate in the TV menus.

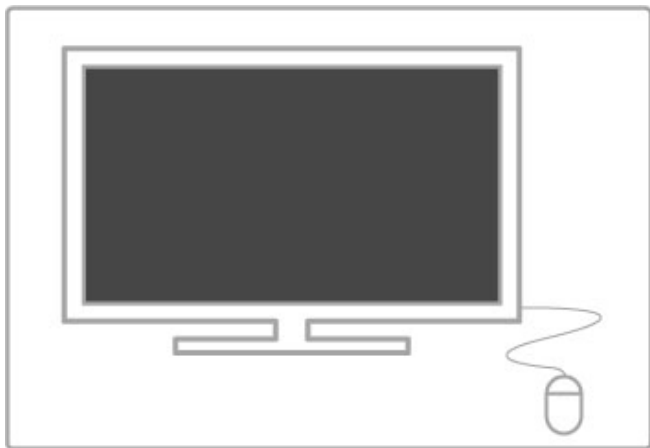

Install

Switch the TV on and connect the USB mouse to one of the USB connections on the side of the TV. You can also connect the USB mouse to a connected USB keyboard.

Mouse clicks

- Left click = OK
- Right click = Back ↩

You can use the scroll wheel to scroll pages up and down.

TV as PC monitor

You can connect the TV to your home network wireless. With Wi-Fi MediaConnect, you can use the TV as a PC monitor. Read **Help > Setup > Network > Wi-Fi MediaConnect**.

Read on to connect a computer to the TV as a PC monitor wired. You can use a VGA cable or a DVI to HDMI adapter.

Use a VGA cable to connect the PC to the VGA connector and an audio L/R cable to connect the VGA Audio L/R to the back of the TV.

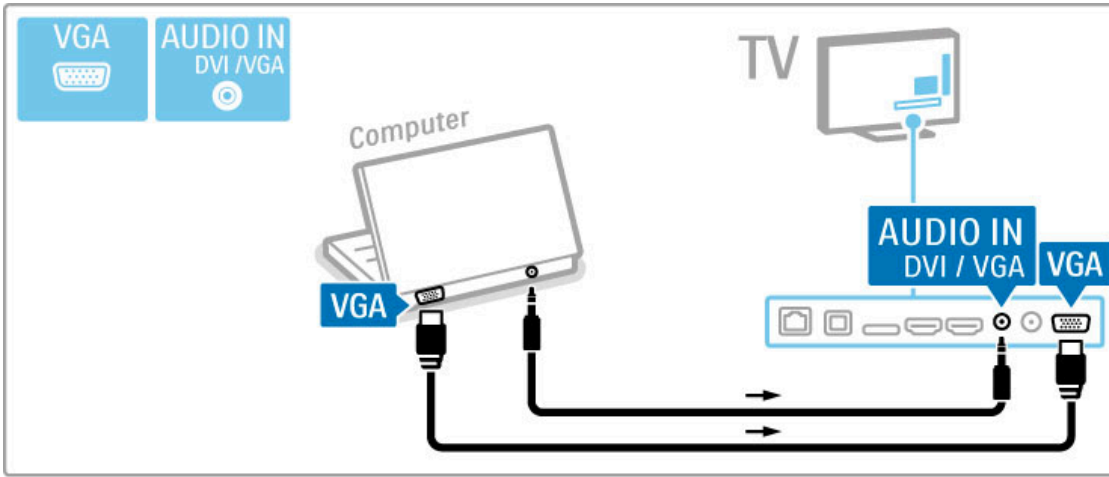

Use a DVI to HDMI adapter to connect the PC to HDMI and an audio L/R cable to connect the Audio L/R to the back of the TV.

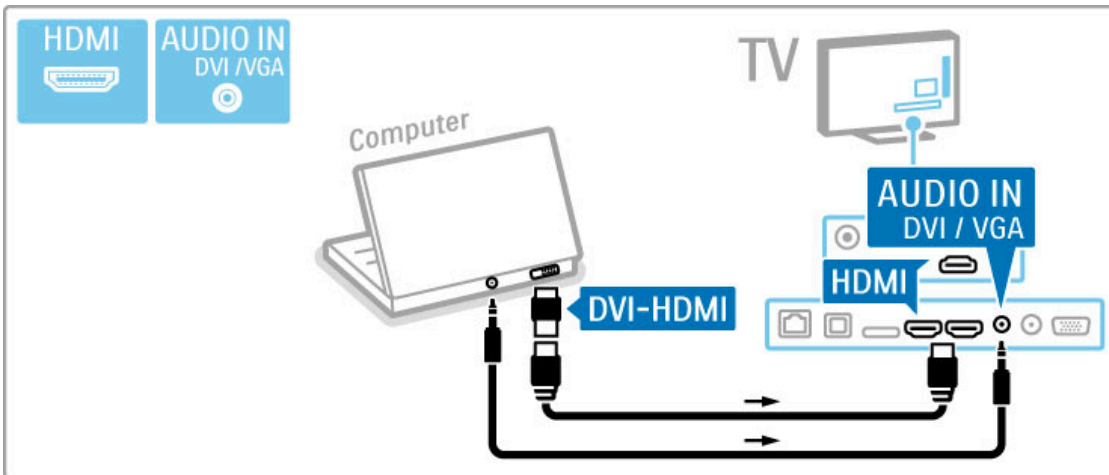

Ideal TV setting

Set the TV picture format to Unscaled for the sharpest picture quality. While watching TV, press **⏏** ADJUST, select **Picture format** and select **Unscaled**.

For a list of supported resolutions see **Help > Specifications > Display resolutions**.

5.5 Network

Wireless

To set up the wireless network connection, read **Help > Setup > Network**.

Wired

To set up the wired network connection, read **Help > Setup > Network**

Connect the router to the TV with a network cable. To fulfil EMC regulations, use a shielded FTP Cat. 5E Ethernet cable.

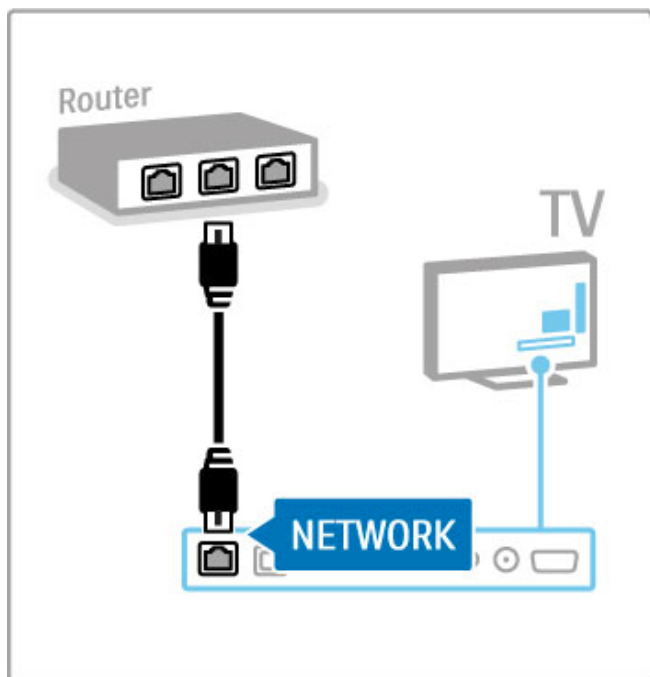

5.6 SD card

Memory size

To store videos downloaded from a Video store on Net TV, you need to insert an SD memory card into the TV SD card slot. Once formatted, leave the card permanently in the slot.

SD memory card size

Use a SD HC (High Capacity) memory card with at least 4GB of storage capacity.

For high-definition (HD) video, use an SD card with at least 8GB of storage capacity. Use a speed class 2 card or more.

Read more about renting videos in [Help > Smart TV > Net TV > Video stores](#).

Insert the card

Make sure to unlock the SD memory card before you insert it.

To format the SD card, switch on the TV and insert the SD card into the SD card slot. The TV will automatically start formatting. Leave the SD card permanently in the slot.

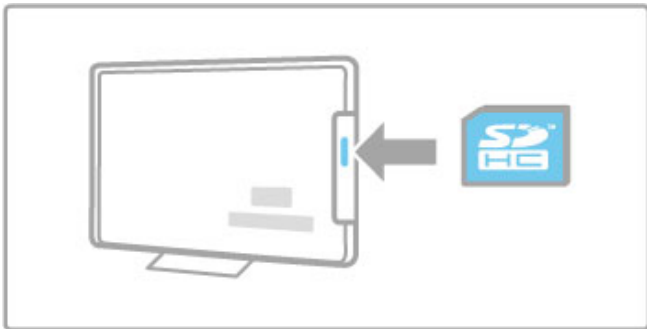

5.7 Common interface CAM

CAM

Scrambled digital TV channels can be decoded with a Conditional Access Module (CAM). Digital TV service operators provide the CAM when you subscribe to their services. Contact a digital TV service operator for more information and to see terms & conditions.

Insert a CAM

Switch off the TV before inserting a CAM. Look on the CAM for the correct method of insertion. Incorrect insertion can damage the CAM and the TV.

Look for the common interface slot on the back of the TV. Gently insert the CAM as far as it will go and leave it in the slot permanently.

It can take a few minutes before the CAM is activated. Removing the CAM will deactivate the service on TV.

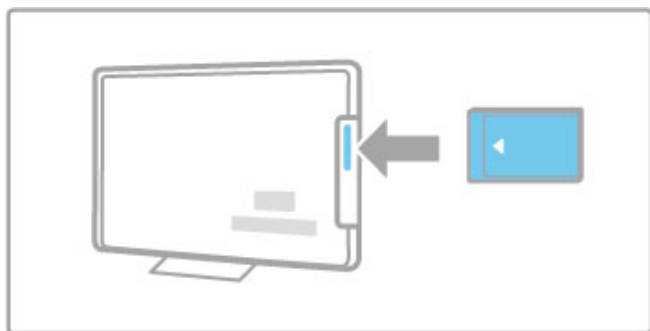

Watching a CAM service

If a CAM is inserted and subscription fees have been paid, the TV shows the programme from the digital TV service provider. The applications, their function, the content and the onscreen messages all come from the CAM service.

CAM settings

To set passwords or PIN codes for the CAM service, press **⬆** > **Setup** > **Channel settings** > **Common Interface**. Select the CAM provider and press **OK**.

CI+

This TV can handle the CI+ conditional access.

CI+ allows service providers to offer premium HD digital programmes like movies and sports with a high level of copy protection.

To insert a CI+ CAM, read chapter **CAM - Conditional Access Module**.

6 Troubleshooting

6.1 Contact information

If the advice and suggestions in Troubleshooting do not help resolve the problem, try switching the TV off and back on again.

Warning

If your TV breaks down, **NEVER** try to repair the TV yourself.

Consumer Care

If the TV problem is not solved you can call the Consumer Care hotline in your country. Look up the TV model and serial number before you call. Find the telephone number on the documentation that came with the TV. Or consult our website www.philips.com/support

TV model number and serial number

Find these numbers on the packaging label or on the type label on the back or bottom of the TV.

6.2 TV and remote control

The TV does not switch on

- Switch the TV off and on again with the switch on the bottom of the TV.
- Check the power cable connection.
- Try using the keys on the TV to switch on.

The TV does not switch on from standby

- Check that the batteries of the remote control are not empty or weak. Check their + / - orientation.
- Try using the keys on the TV to switch on.

The TV does not respond to the remote control

- Check that the batteries of the remote control are not empty or weak. Check their + / - orientation.
- Clean the remote control and TV sensor lens.

- During start-up, which can take up to two minutes with connected devices, the TV and some external devices do not immediately respond to commands from the remote control. The device is functioning normally and is not broken.

The TV switches off and the red light flashes

- Switch the TV off and on again with the switch at the bottom of the TV. Check if there is enough space for ventilation. Wait until the TV has cooled down.

If the TV does not restart from standby and the light flashes again, call Consumer Care.

You forgot your code to unlock Child lock?

Read **Help > Smart TV > Locks and timers > Child lock**.

6.3 TV channels

Some TV channels are gone

- Check if the correct list is selected in the Channel list. Press **Q** **FIND** to open the Channel list, then press **≡** **OPTIONS** and select the list you need with **Select list**.

- A channel could be hidden in the Channel list. Read more about Channel list in **Help > Basics > Watch TV > Channel list**.

No digital channel found during installation

- Check if the TV supports DVB-T or DVB-C in your country. Check the 'Digital TV Country Compatibility' sticker on the back of the TV.

6.4 Picture and sound

No picture

- Check if the antenna is connected properly.
- Check if the correct device is selected and connected properly.
- Check the contrast or brightness setting in **🏠 > Setup > TV settings > Picture > Contrast** or **Brightness**.

The picture is poor

- Bad weather can influence the picture quality.
- Check if the antenna is connected properly.
- Non-earthed audio devices, neon lights, high buildings or mountains can influence the picture quality. Try to improve the picture by changing the position of the antenna or placing devices away from the TV.

- Check that the correct TV system is chosen in the Manual installation menu.
- If only a certain channel is poor, try to fine tune this channel with the Fine tune menu.

Read **Help > Setup > Channels > Manual installation - Analogue**.

The picture has poor colour

- Check the colour settings in **🏠 > Setup > TV settings**. Or press **☰ OPTIONS** to select a **Smart picture** setting.

Picture delay when a game console is connected

- To prevent picture delay, press **☰ OPTIONS**, select **Smart picture > Game**.

The TV does not remember my settings when I switch it back on

- Check whether the TV is set to the **Home** location. Press **🏠 > Setup > TV settings > Preferences > Location**.

The picture does not fit the screen

- Press **☰ OPTIONS**, **Picture format** and select **Auto fill**.

The picture position on screen is not correct

- To correct a shifted picture, press **☰ OPTIONS** and select **Picture shift**. Use the navigation keys to adjust the picture position. Press **OK** to stop Picture shift.

- If distorted screen edges are visible, press **🏠 > Setup > TV settings > Picture > Screen edges** and use the slider bar to enlarge the picture slightly.

There is a picture but no sound

- Check the volume is not set to 0.
- Check the sound has not been muted with **🔇**.
- Check that all cables are connected properly.
- If no sound signal is detected, the TV automatically switches off sound. This is proper operation and is not a malfunction.

The sound is poor

- Try any Smart sound setting, press **☰ OPTIONS**, **Smart sound**.
- Check that the sound is set to Stereo.

The sound comes from one speaker only

- Check the Balance setting, Press **🏠 > Setup > TV settings > Sound > Balance**. Use the slider bar to set the balance.

Sound delay

- If there is an audio to video sync mismatch when sound comes from a Home Theatre System, an audio sync delay needs to be set up. Read more about Audio to Video sync in **Help > Setup > Devices > Audio to Video sync**.

6.5 Devices

HDMI connections

- The HDMI-HDCP procedure might take a few seconds before the picture from a device appears.
- If the TV does not recognise the device and there is no picture, try switching from one device to another and back again to restart the HDCP procedure. Or switch the device off and back on again.

- If sound interruptions occur persistently, see the user manual of the device to check the output settings. If that does not help, connect an additional audio cable.
- If a DVI to HDMI adaptor is used, check that an additional audio connection is in place to complete the DVI connection.

EasyLink HDMI-CEC

- Check if the connected device supports the HDMI-CEC standard and is properly set up. Read the user manual that comes with the device.
- Check if the HDMI cable is properly connected.

- Check if EasyLink on the TV and device is switched on.
- Make sure that the System audio control in your HDMI-CEC audio devices is properly set up. Read the user manual that comes with your audio device.

PC display

- The refresh rate of a PC connected to the TV with VGA or DVI to HDMI adapter should set to 60Hz.
- Check that the correct resolution mode is selected on your PC. See the list in **Help > Specifications > Display resolutions**.

6.6 Videos, photos and music

The files on my USB device are not shown

- Set your device (camera) to 'Mass Storage Class' compliant.
- The USB device may need specific driver software.

Unfortunately, this software cannot be downloaded to your TV.

- Not all audio and picture files are supported. See the list in **Help > Specifications > Multimedia**.

Files from a USB device do not play back smoothly

- The transfer performance of the USB device limits the transfer rate.

The files on my PC are not shown

- To look for files on your home network with Browse PC, your PC media server software should be set up to share the files with the TV. See the list of compatible Media server software in **Help > Specifications > Multimedia**.

6.7 Network

Wireless network not found or distorted

- Microwave ovens, Dect phones or other WiFi 11b devices in your neighbourhood might disturb the wireless network.
- Make sure that the firewalls in your network allow access to the TV wireless connection.

- If the wireless network does not work properly in your home, try the wired network installation. Read **Help > Setup > Network > Wired installation**.

Net TV does not work

- If the connection to the router is OK, check the router connection to the Internet.

Browse PC or Net TV work slow

- Look in your wireless router's user manual for information on indoor range, transfer rate and other factors of signal quality.
- You need a high-speed (broadband) Internet connection for your router.

7 Specifications

7.1 Software

Software version

To view the current TV software version, press **⏠** > **Setup** > **Software settings** and press **OK**. Select **Current software info** and read **Version**.

Open source software

This television contains open source software. TP Vision Netherlands B.V. hereby offers to deliver, upon request, a copy of the complete corresponding source code for the copyrighted open source software packages used in this product for which such offer is requested by the respective licences.

This offer is valid up to three years after product purchase to anyone in receipt of this information. To obtain the source code, please contact open.source@philips.com.

If you prefer not to use email or if you do not receive a confirmation receipt within a week after mailing to this email address, please write in English to . . .

Open Source Team, TP Vision Netherlands B.V.
Intellectual Property and Standards
P.O. Box 220
5600 AE Eindhoven
The Netherlands

Read the Open Source Licences in **Help** > **Getting started** > **Open Source Licences**.

7.2 Environmental

EU Energy Label

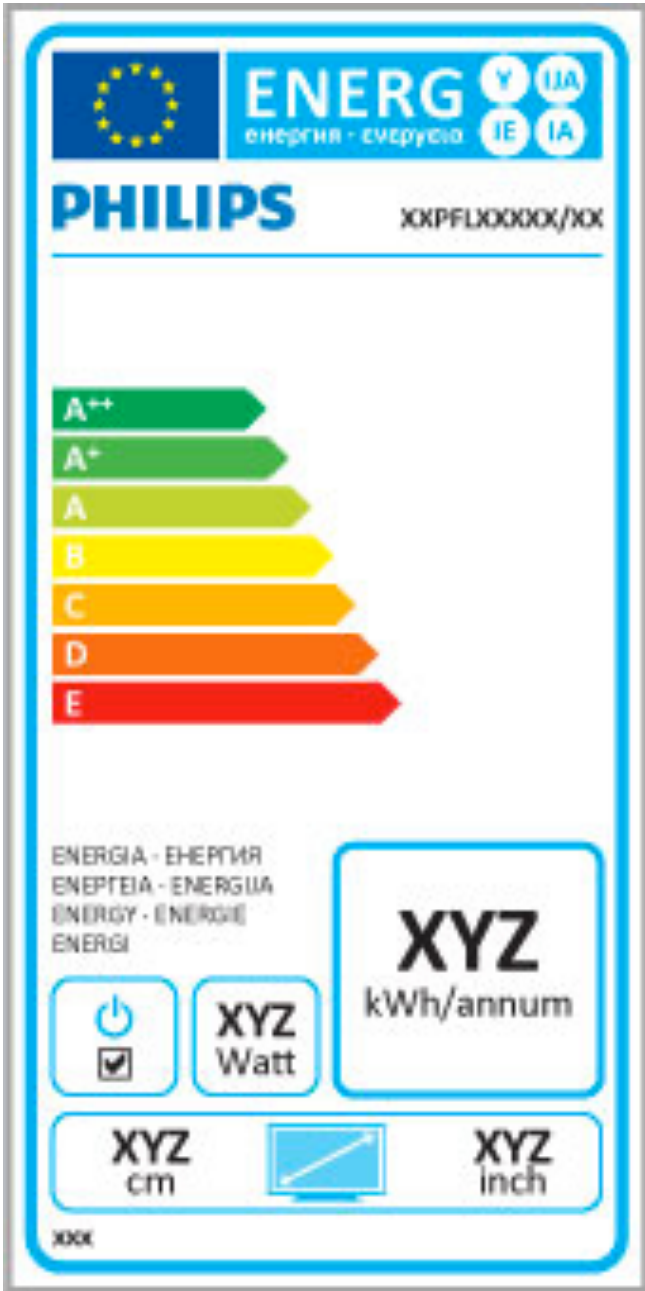

EU Energy label

The European Energy Label informs you on the energy efficiency class of this product. The greener the energy efficiency class of this product is, the lower the energy it consumes.

On the label, you can find the energy efficiency class, the average power consumption of this product in use and the average energy consumption for 1 year. You can also find the power consumption values for this product on the Philips website for your country at

www.philips.com/TV

Energy saving

Light sensor

To save energy, the built-in ambient light sensor lowers the brightness of the TV screen when the surrounding light darkens.

Energy saving

The energy saving Smart picture setting, combines several TV settings that result in saving energy.

Low standby power

The class-leading and highly advanced power circuitry brings down the power consumption of the TV to an extremely low level, without losing out on the constant Standby functionality.

Power management

The advanced power management of this TV ensures the most efficient use of energy. You can check how your personal TV settings, the level of brightness in current onscreen pictures, and the surrounding light conditions determine the relative power consumption.

To check the relative power consumption, press **↑** > **Setup** and press **▶**. Select **Watch demos** > **Active control** and press **OK**. Select a Smart setting to check the corresponding values.

End of use

Disposal of your old product and batteries

Your product is designed and manufactured with high quality materials and components, which can be recycled and reused.



When this crossed-out wheeled bin symbol is attached to a product it means that the product is covered by the European Directive 2002/96/EC.

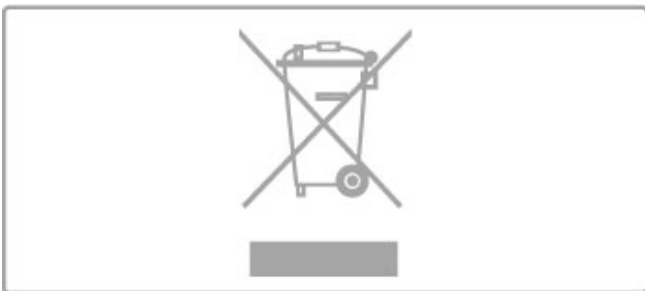

Please inform yourself about the local separate collection system for electrical and electronic products.

Please act according to your local rules and do not dispose of your old products with your normal household waste. Correct disposal of your old product helps to prevent potential negative consequences for the environment and human health.

Your product contains batteries covered by the European Directive 2006/66/EC, which cannot be disposed with normal household waste.



Please find out for yourself about the local rules on separate collection of batteries because correct disposal will help to prevent negative consequences for the environment and human health.

7.3 Power and reception

Power

Product specifications are subject to change without notice. For more specification details of this product, see www.philips.com/support.

Power

- Mains power : AC 220-240V +/-10%
- Ambient temperature : 5°C to 35°C
- Standby power consumption : < 0.15W
- Power saving features : Light sensor, Eco mode, Picture mute (for radio), Auto switch-off timer, Eco settings menu.

The power rating stated on the product typeplate is the power consumption for this product during normal household use (IEC 62087 Ed.2). The maximum power rating, stated between brackets, is used for electrical safety (IEC 60065 Ed. 7.2).

Reception

- Aerial input : 75 ohm coaxial (IEC75)
- Tuner bands : Hyperband, S-Channel, UHF, VHF
- DVB : DVB-T (terrestrial, antenna) COFDM 2K/8K, DVB-T2 : only for TV types '... T/12', DVB-C (cable) QAM

- Analogue video playback : NTSC, SECAM, PAL
- Digital video playback : MPEG2 SD/HD (ISO/IEC 13818-2), MPEG4 SD/HD (ISO/IEC 14496-10)
- Digital audio playback (ISO/IEC 13818-3)
- See selected countries on the TV type plate

7.4 Display and sound

Display / Picture

- Diagonal size :
 - 40PFL8606 : 102 cm / 40"
 - 46PFL86x6 : 117 cm / 46"
- 3D Max
- Picture enhancement :
 - Perfect Pixel HD Engine
 - Wide Colour Gamut
 - Scanning backlight

- Display type : LED Full HD, edge LED backlight
- Panel resolution : 1920 × 1080p
- Colour processing : 2250 trillion colours 17bit RGB
- Brightness : 450 cd/m²
- Dynamic contrast :
 - 500.000 : 1
- Response time (typical) : 1 (BEW equiv.) ms

Sound

- Output power (RMS) : 28W @30%THD
- Dolby Digital, Dolby Digital Plus, Dolby Pulse - Dolby and the double-D symbol are registered trademarks of Dolby Laboratories.
- Speaker types : 2 woofers in Soundstage stand

7.5 Display resolutions

Video formats

Resolution — Refresh rate

- 480i - 60 Hz
- 480p - 60 Hz
- 576i - 50 Hz
- 576p - 50 Hz
- 720p - 50 Hz, 60 Hz
- 1080i - 50 Hz, 60 Hz
- 1080p - 24 Hz, 25 Hz, 30 Hz
- 1080p - 50 Hz, 60 Hz

Computer formats

Resolutions (amongst others)

- 640 × 480p — 60 Hz
- 800 × 600p — 60 Hz
- 1024 × 768p — 60 Hz
- 1280 × 768p — 60 Hz
- 1360 × 765p — 60 Hz
- 1360 × 768p — 60 Hz
- 1280 × 1024p — 60 Hz
- 1920 × 1080i — 60 Hz
- 1920 × 1080p — 60 Hz

7.6 Multimedia

Connections

- USB 2.0
- Ethernet LAN RJ-45
- Wi-Fi 802.11b/g/n (built-in)

Supported USB file systems

- FAT 16, FAT 32, NTFS

Playback formats

- Containers : MPEG Program Stream, MPEG Transport Stream, AVI, MPEG-4, Matroska, Windows Media, ASF
- Video Codecs : MPEG-1, MPEG-2, MPEG-4 Part 2, MPEG-4 AVC (H264), WMV9
- Audio Codecs : MP3, AAC, HE-AAC V1, HE-AAC V2, WMA, AC3
- Image Codecs : JPEG
- Limitations : WMA (V2 up to V9.2), MPEG-4 AVC (up to level 4.0)

Supported DLNA media server software (DMS)

- Windows Media Player 11 (for Microsoft Windows XP, Vista or Windows 7)
- TVersity 1.9.3 (pro) (for Windows XP)
- Twonky Media — PacketVideo 4.4.9 (for PC and Intel MacOX)
- Nero 9 — Nero MediaHome (for Microsoft Windows XP)
- Sony Vaio Media Server (for Microsoft Windows XP or Vista)

- Sony PS3 media server (for Windows XP)
- Google Media Server (Google desktop) (for Windows XP)
- DiXiM (for Windows XP)
- Macrovision Network Media Server (for Windows XP)
- Philips NAS SPD8020 (v. 1.2.9.47)
- Fuppes (for Linux)
- uShare (for Linux)

Supported DLNA mobile devices (DMS/DMC)

- Nokia N78, N80, N81, N82, N92, N93, N93i, N95, N96, N800, N810
- Samsung SGH-i780

ESD regulations

This apparatus meets performance criteria A for ESD. In case the apparatus does not recover in DLNA mode due to electrostatic discharge, user interference is required.

7.7 Connectivity

TV Rear

- EXT1 SCART (adapter included): Audio L/R, CVBS in, RGB
- EXT2 YPbPr: Y Pb Pr, Audio L/R
- VGA (D-sub 15)
- HDMI 1 in ARC (v1.4 - 3D)
- HDMI 2 in (v1.4 - 3D)
- HDMI 3 in (v1.4 - 3D)
- Audio In (DVI to HDMI / VGA) (stereo mini-jack 3.5mm)

- Audio Out L/R — display synchronised (optical)
- Headphones (stereo mini-jack 3.5mm)
- Network LAN — (RJ45)

TV Side

- HDMI Side in (v1.4 - 3D)
- 2x USB
- Common interface slot (CAM)
- SD card slot (SD High Capacity) (as Video stores memory)

7.8 Dimensions and weights

40PFL8606

Width 950 mm
Height 582 mm
Depth 33 mm
Weight ± 15 kg
. . . with TV stand
Height 636 mm
Depth 244 mm
Weight ± 18 kg

46PFL8606

Width 1088 mm
Height 662 mm
Depth 35 mm
Weight ± 20 kg
. . . with TV stand
Height 716 mm
Depth 244 mm
Weight ± 23 kg

46PFL8686

Width 1088 mm
Height 662 mm
Depth 35 mm
Weight ± 20 kg
. . . with TV stand
Height 716 mm
Depth 244 mm
Weight ± 23 kg

UMv 3104 327 0055.3 - 120229

Index

3

- 3D depth 22
- 3D glasses 22
- 3D, 2D to 3D 22
- 3D, start 22

A

- Adjust menu 16
- Ambilight colour 39
- Ambilight, setup 39
- Ambilight, switch on 39
- Audio Description 46
- Audio Out delay 45
- Auto switch off 37

B

- Balance 37
- Black bars 21

C

- CAM 66
- Channel list copy 41
- Channel list, options 18
- Channel, favourite 19
- Channel, rename 19
- Channel, reorder 18
- Channel, switch 18
- Channel, update 41
- CI+ 66
- Clock 42
- Common interface slot 66
- Component Video YPbPr 49
- Connections 49
- Connections, guide 49
- Consumer Care 67

D

- Device, add 16
- Device, remove 16
- Device, rename 16
- Device, reorder 16
- Digital Text 35
- DVB 42
- DVD player, connect 51
- DVI to HDMI adapter 49

E

- EasyLink, remote control 45
- Eco settings 37
- Encryption method 43
- ESD 80
- Expired recording 33

F

- Failed recording 33
- Find 16

G

- Game console 34
- Gamma 37

H

- HbbTV 29
- HbbTV, block 29
- HbbTV, pages 29
- HD TV 6
- HD video clip 6
- HDMI ARC 49
- HDMI connection 49

- Headphone volume 37
- Help, Search 12
- Home menu 16

I

- Infrared sensor 14
- Internet 43
- ISF Calibration, picture 38

K

- Keyboard, on screen 19

L

- Lock code 25

M

- Media server software 80
- Music with photos 30

N

- Net TV 26
- Net TV, connection 26
- Net TV, open 27
- Network, wired connection 64
- Network, wired installation 44
- Network, wireless installation 43

O

- One Touch Play 14
- Online, rental video 27
- Open source software 74
- Options menu 17

P

- Parental rating 25
- Pause TV 32
- Pause TV, installation 32
- PC, browse 30
- PC, connect 30
- PC, monitor 62
- Perfect Pixel HD Engine 37
- Photos 30
- Photos, slideshow 30
- Picture settings 37
- Picture shift 17
- Play videos 30
- Power consumption 76
- Product recycling 76

R

- Radio channels 18
- Reception quality 42
- Recording, installation 32
- Recording, watch a 33
- Rental video 27
- Router 43

S

- Screen edges 37
- SD card, install 65
- Select list 18
- Smart setting, sound 20
- Smart settings, reset 38
- Software, current version 47
- Software, Internet update 47
- Software, USB update 47
- Sound settings 37
- Subtitle, auto shift 45
- Subtitles, language 25
- Subtitles, On during mute 25
- Surround mode 14
- Surround sound 17
- System standby 14

T

Text, dual screen 35
Text, freeze 35
Text, setup 36
Text, T.O.P. overview 35
TV network name 44
TV tour 5

U

Universal access 46
USB Hard Drive 32
USB Hard Drive, installation 32
USB keyboard 61
USB mouse 62
USB, browse 30

V

Video (CVBS) connection 50
Video selection 18

W

Wall colour 39
Watch TV 18
WEP security encryption 43
WPA security encryption 43
WPS (Wi-Fi Protected Setup) 43



Contact information

Argentina

0800 444 7749
Buenos Aires 0810 444 7782

België / Belgique

070 700 035 (0,15€/min.)

Brazil

0800 701 0245
Sao Paulo 2938 0245

България

02 4916 273 - Местен разговор

Česká republika

228880895 (Národní volání)

Danmark

3525 8314

Deutschland

0180 501 04 69 (0,14€/Min.)

Ελλάδα

2111983028 (Εθνική κλήση)

España

902 88 10 83 (0,10€ + 0,08€/min.)

Estonia

6683061 (riigisisese kõne)

France

01 57 32 40 50 (local)

Hrvatska

01 777 66 01 (nacionalni poziv)

Italia

0245 28 70 14 (chiamata nazionale)

Ireland

0818 210 140 (national call)

Northern Ireland

0844 338 04 88 (5p/min BT landline)

Қазақстан

8 800 2000 00 04 (free)

Latvia

6616 3263 (Valsts telefona zvans)

Lithuania

8 5 214 0293 (Nacionalinė skambutis)

Luxembourg / Luxemburg

2487 1100 (Nationale Ruf / appel national)

Magyarország

06 1 700 8151 (Országos felhívás)

Nederland

0900 202 08 71 (0,10€/min.)

Norge

22 97 19 14

Österreich

0820 40 11 33 (0,145€/Min.)

Polska

22 397 15 04 (połączenie Narodowy)

Portugal

707 78 02 25 (0,12€/min. - Móvel
0,30€/min.)

România

031 6300042 (națională de apel telefonic)

Россия

8-800-22 00004 (бесплатно)

Suisse / Schweiz / Svizzera

0848 000 291 (0,081 CHF/Min.)

Србија

+381 114 440 841 (Lokalni poziv)

Slovakia

2 332 154 93 (Národný telefónny hovor)

Slovenija

1 888 83 12 (Državni telefonski klic)

Suomi

09 88 62 50 40

Sverige

08 5792 9096 (lokalsamtal)

ประเทศไทย (Thailand)

02 652 7650

Türkiye

444 8 445

United Kingdom

0844 338 04 88 (5p/min BT landline)

Україна

0-800-500-480 (безкоштовно)

www.philips.com/support

Non-contractual images / Images non contractuelles / Außervertragliche Bilder



Specifications are subject to change without notice.

Philips and the Philips' shield emblem are registered trademarks of Koninklijke Philips Electronics N.V. and are used under license from Koninklijke Philips Electronics N.V.

All registered and unregistered trademarks are property of their respective owners.

2012 © TP Vision Netherlands B.V. All rights reserved.

www.philips.com