

Register your product and get support at  
[www.philips.com/welcome](http://www.philips.com/welcome)

BDP3280K/93



---

|       |             |    |
|-------|-------------|----|
| EN    | User manual | 9  |
| ZH-CN | 用户手册        | 33 |

---

**PHILIPS**



**EN**

Before you operate this Blu-ray disc/ DVD player, read and understand all accompanying instructions.

**ZH-CN**

开始连接此蓝光光盘/DVD 播放机之前，请先阅读并理解所有附带的说明。

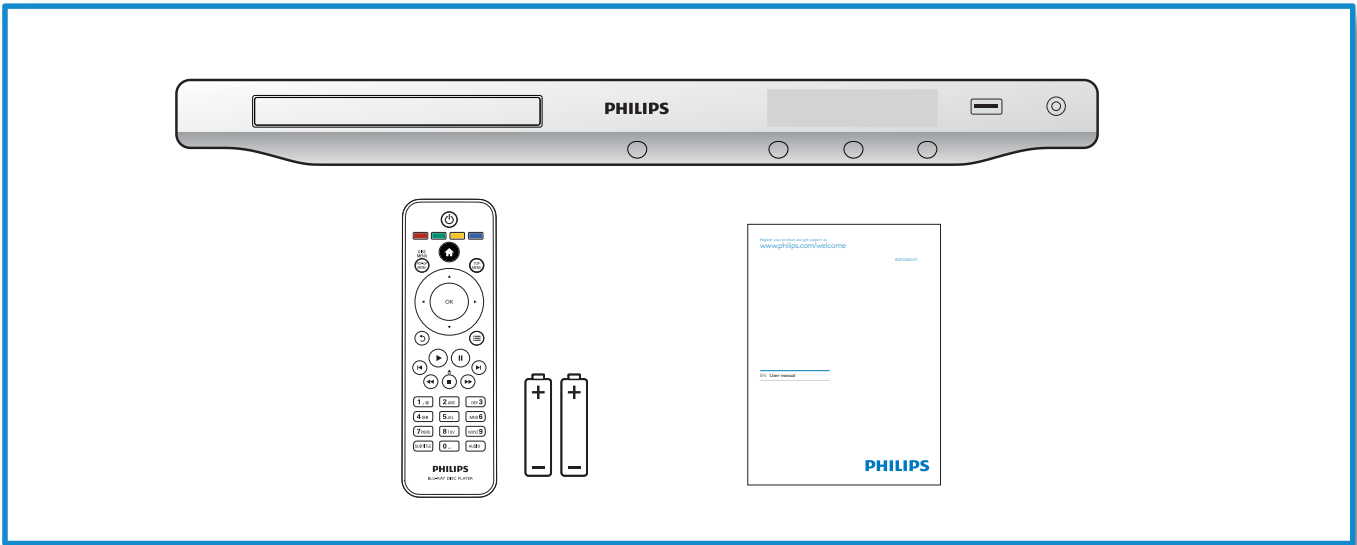

# 1

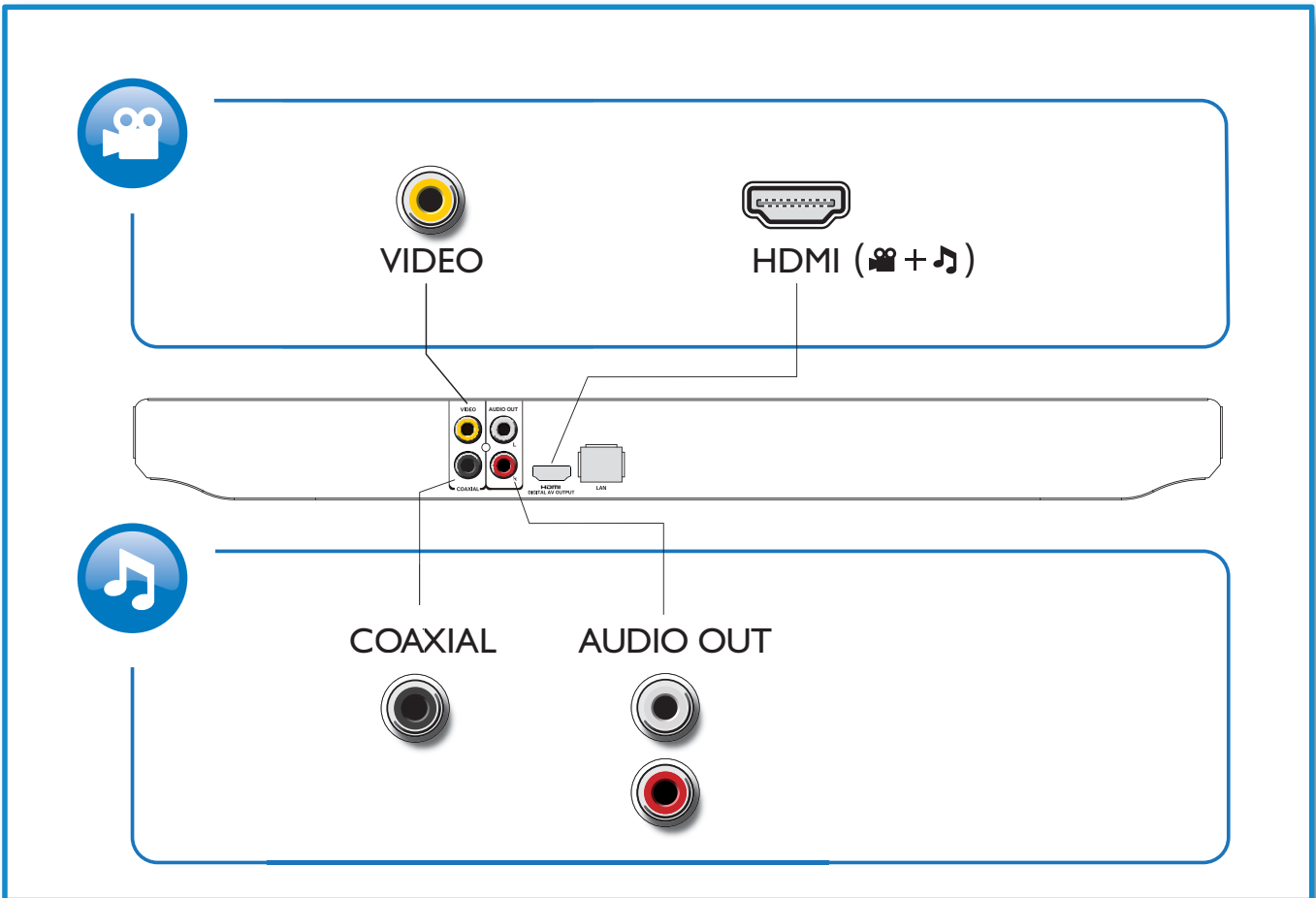

# 2



## 1 HDMI



HDMI VIDEO COAXIAL AUDIO OUT

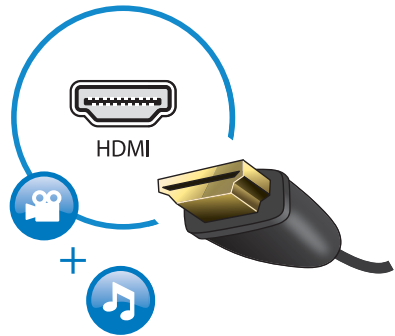
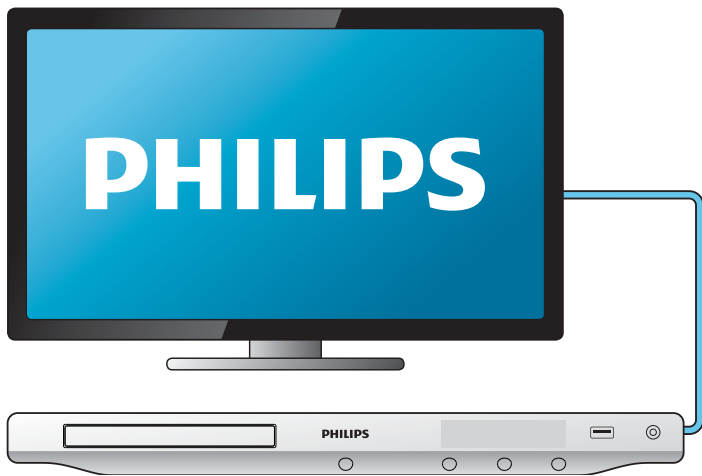

## 2 VIDEO+AUDIO OUT



HDMI VIDEO COAXIAL AUDIO OUT

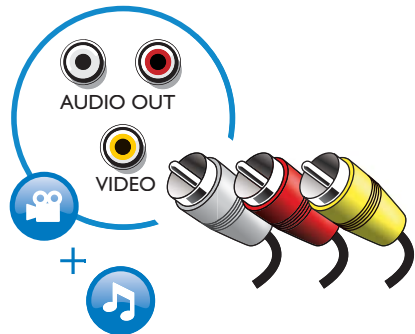
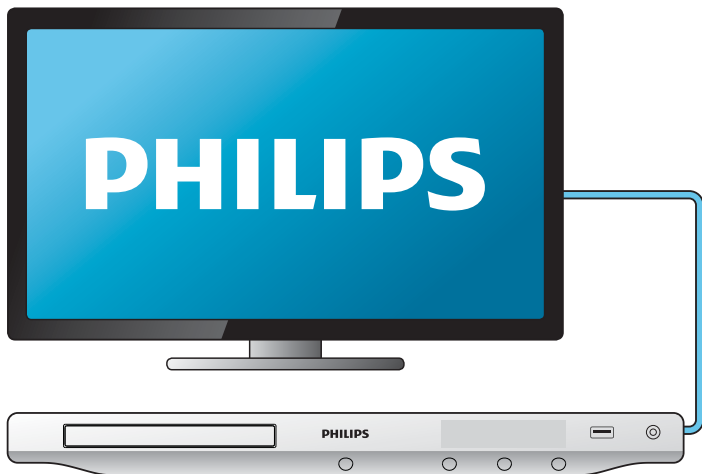

### 3 COAXIAL

HDMI  VIDEO  COAXIAL  AUDIO OUT

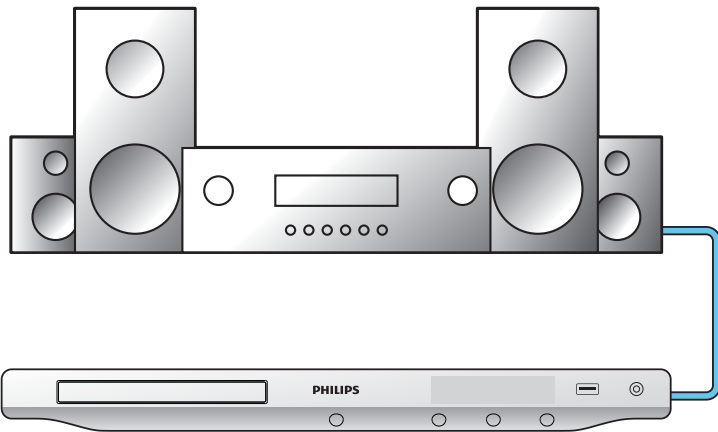

### 4 AUDIO OUT

HDMI  VIDEO  COAXIAL  AUDIO OUT

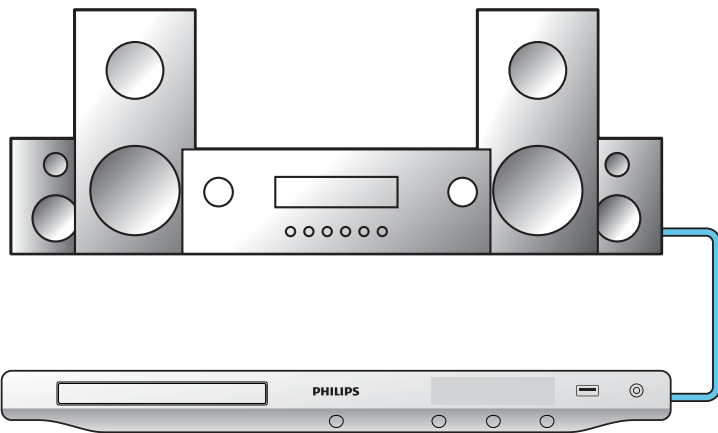

3

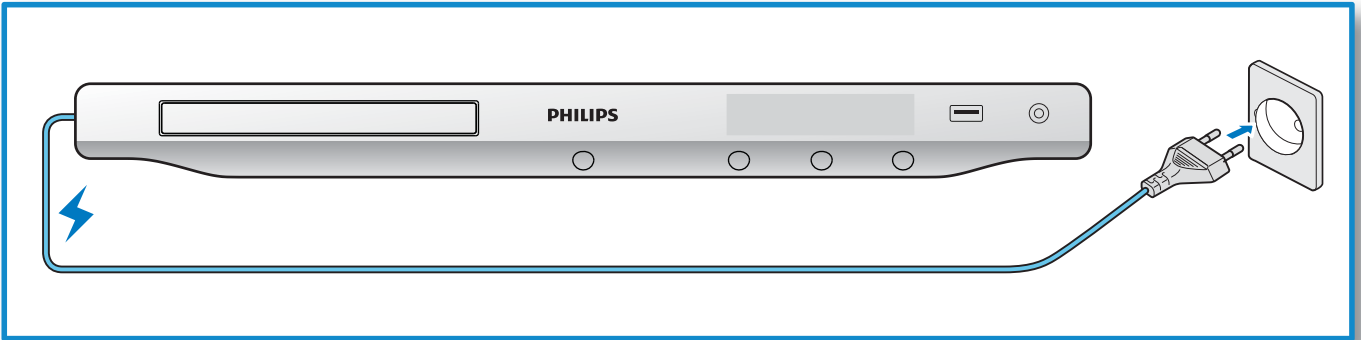

4

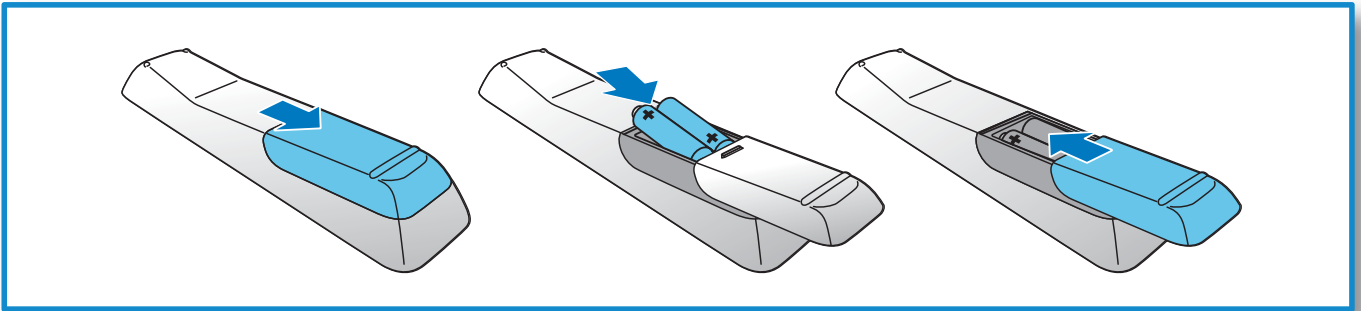

5

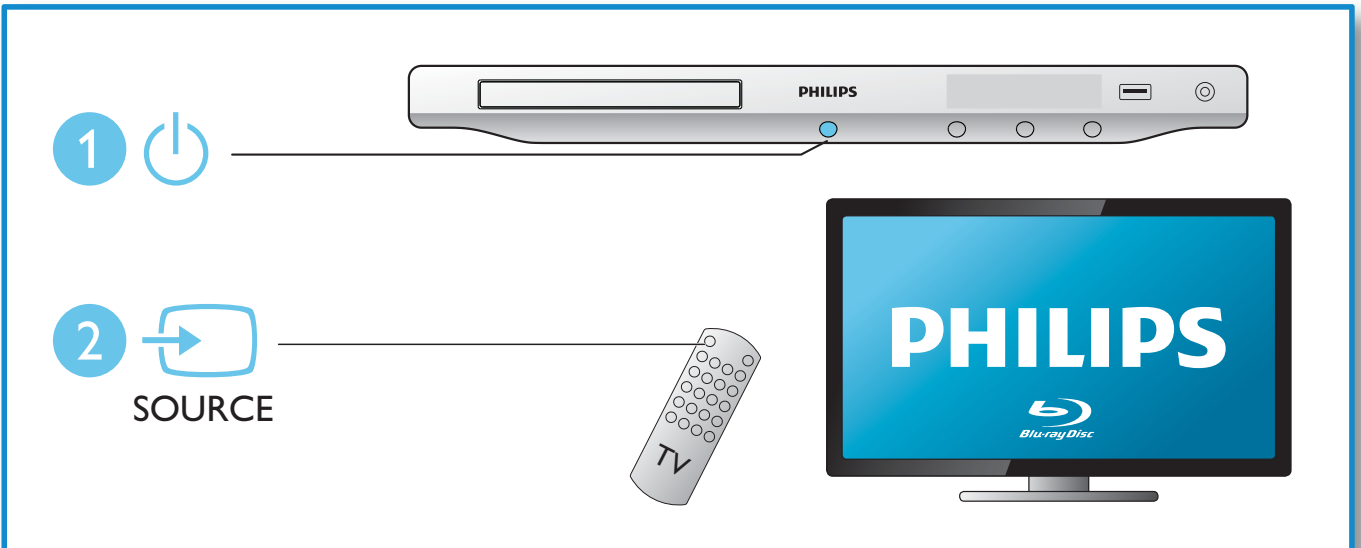

# 6



2

BD/3D  
DVD/VCD/CD  
DivX Plus HD/MKV  
MP3 / JPEG

1



3

4

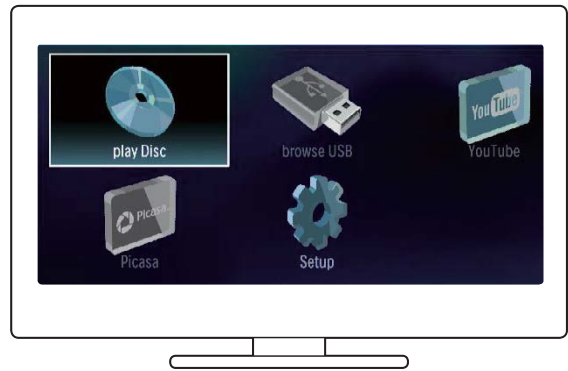
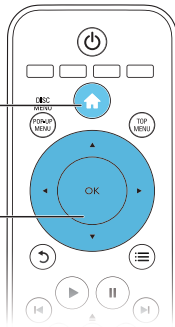

1

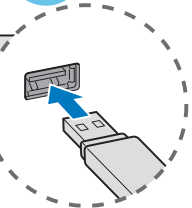

2

3

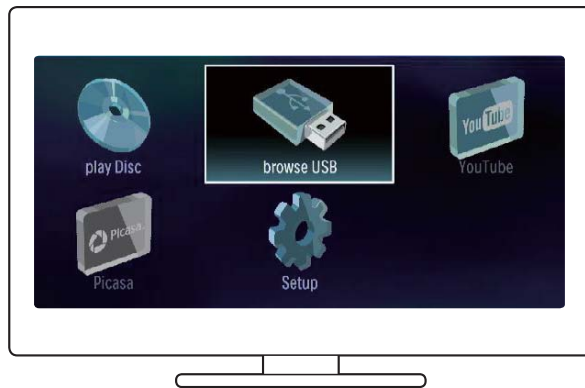
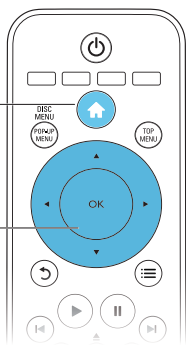





# 目录

|                           |            |
|---------------------------|------------|
| <b>1 连接和播放</b>            | <b>2-7</b> |
| <b>2 使用您的蓝光光盘/DVD 播放机</b> | <b>34</b>  |
| 基本播放控制                    | 34         |
| 视频、音频和图片选项                | 35         |
| DivX 视频                   | 37         |
| RMVB 或 RM 文件              | 37         |
| 播放音乐幻灯片                   | 38         |
| 蓝光光盘上的 BonusView 功能       | 38         |
| 蓝光光盘上的 BD-Live 功能         | 38         |
| 播放蓝光 3D 视频                | 39         |
| 设置网络                      | 39         |
| 卡拉 OK                     | 40         |
| 使用 Philips EasyLink       | 41         |
| <b>3 更改设置</b>             | <b>42</b>  |
| 画面                        | 42         |
| 声音                        | 43         |
| 网络（安装、状态...）              | 43         |
| 首选项（语言、家长控制...）           | 43         |
| 高级选项（BD-Live 安全性、清除存储...） | 44         |
| <b>4 更新软件</b>             | <b>45</b>  |
| 通过互联网更新软件                 | 45         |
| 通过 USB 设备更新软件             | 45         |
| <b>5 规格</b>               | <b>46</b>  |
| <b>6 故障种类和处理方法</b>        | <b>48</b>  |
| <b>7 安全和重要注意事项</b>        | <b>51</b>  |

## 2 使用您的蓝光光盘/DVD 播放机

感谢您的惠顾，欢迎光临 Philips! 为了您能充分享受 Philips 提供的支持（例如产品软件升级），请在 [www.philips.com/welcome](http://www.philips.com/welcome) 上注册您的产品。

### 基本播放控制

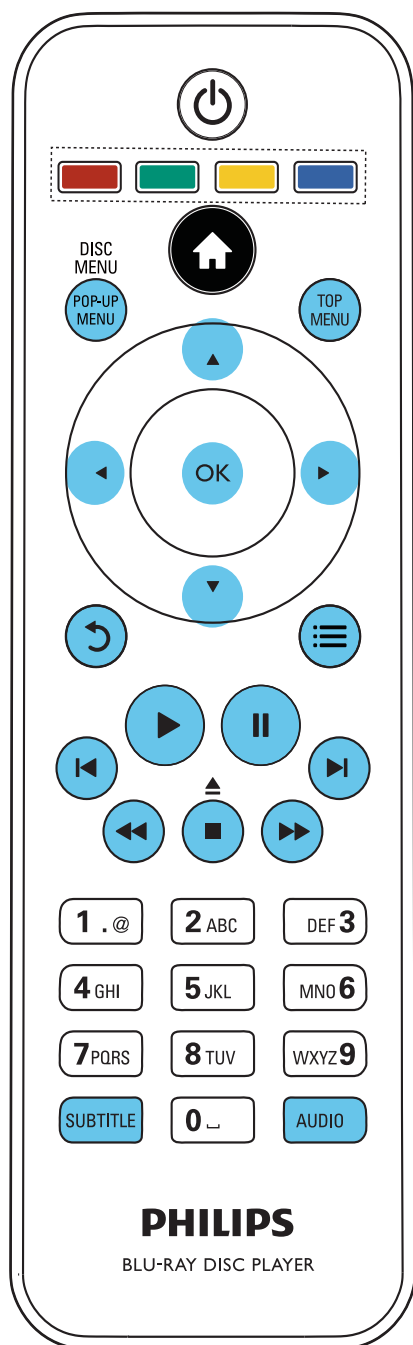

在播放期间，按以下按钮进行控制。

| 按钮                      | 操作   |
|-------------------------|--|
| ▲ / ■                   | 停止播放。<br>按住（超过 4 秒）打开或关闭光盘仓。               |
|                         | 暂停播放。<br>反复按逐帧慢进。                          |
| ▶                       | 开始或继续播放。                                   |
| ◀ / ▶                   | 跳至上一或下一曲目、章节或文件。                           |
| ◀◀ / ▶▶                 | 快退或快进。<br>反复按可更改搜索速度。<br>按一下   ，然后按 ▶▶ 慢进。 |
| AUDIO                   | 选择音频语言或声道。                                 |
| SUBTITLE                | 选择字幕语言。                                    |
| DISC MENU / POP-UP MENU | 进入或退出光盘菜单。                                 |
| TOP MENU                | 访问视频光盘的主菜单。                                |
| 彩色按钮                    | 为蓝光光盘选择任务或选项。                              |
| ▲ ▼ ◀▶                  | 导航菜单。<br>在幻灯片放映期间按 ▲ ▼ 顺时针或逆时针旋转图片。        |
| OK                      | 确认选择或输入。                                   |
| ↶                       | 返回上一个显示菜单。                                 |
| ☰                       | 播放期间访问更多选项。                                |

## 视频、音频和图片选项

用于从光盘或 USB 存储设备播放视频或图片的更多选项。

### 视频选项

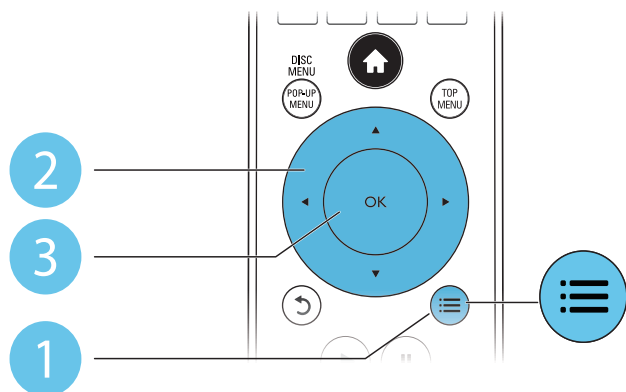

视频播放期间访问更多选项。

- **[音频语言]**: 选择音频语言。
- **[字幕语言]**: 选择字幕语言。
- **[字幕移动]**: 更改字幕在屏幕上的位置。按 ▲ ▼ 更改字幕位置。
- **[信息]**: 显示播放信息。
- **[字符集]**: 选择支持 DivX 视频字幕的字符集 (仅限于 DivX 视频)。
- **[时间搜索]**: 通过遥控器上的数字按钮跳至指定时间。
- **[第二音频语言]**: 选择第二音频语言 (仅限于支持 BonusView 的蓝光光盘)。
- **[第二字幕语言]**: 选择第二字幕语言 (仅限于支持 BonusView 的蓝光光盘)。
- **[标题]**: 选择标题。
- **[章节]**: 选择章节。
- **[卡拉 OK]**: 设置卡拉 OK 功能。
- **[视角列表]**: 选择观看相机角度。
- **[菜单]**: 显示光盘菜单。
- **[PIP 选择]**: 显示画中画窗口 (仅限于支持 BonusView 的蓝光光盘)。
- **[缩放]**: 在视频画面中缩放。按 ◀ ▶ 选择缩放系数。
- **[重复]**: 重复播放章节或标题。
- **[重复 A-B]**: 标记一个章节内用于重复播放的两个点, 或关闭重复模式。
- **[图像设置]**: 选择预设色彩设置。

#### 注

- 可使用的视频选项取决于视频来源。

---

## 图片选项

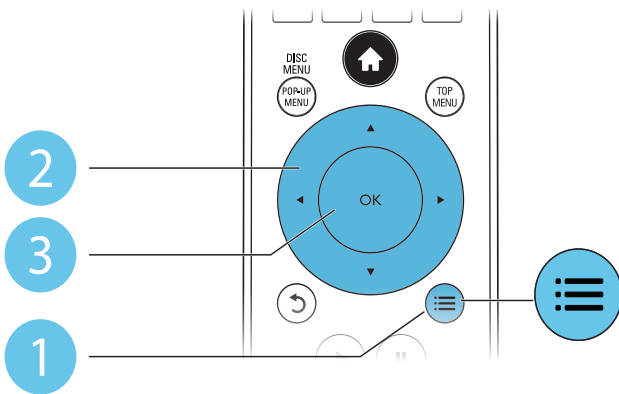

幻灯片放映期间访问更多选项。

- **[顺时针旋转 90 度]**: 顺时针旋转图片 90 度。
- **[逆时针旋转 90 度]**: 逆时针旋转图片 90 度。
- **[缩放]**: 放大图片。按 ◀▶ 选择缩放系数。
- **[信息]**: 显示图片信息。
- **[每张幻灯片的时间]**: 设置幻灯片显示间隔。
- **[幻灯片动画]**: 选择幻灯片的过渡效果。
- **[图像设置]**: 选择预设色彩设置。
- **[重复]**: 重复播放所选的文件夹。

---

## 音频选项

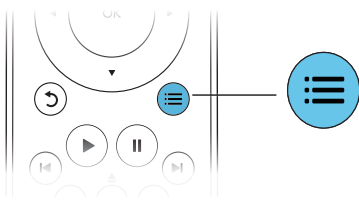

反复按 **≡** 可在以下选项之间循环切换。

- 重复播放当前曲目。
- 重复播放光盘或文件夹中的所有曲目。
- 以随机循环顺序播放音频曲目。
- 关闭重复模式。

## DivX 视频

您可以从光盘或 USB 存储设备播放 DivX 视频。

### DivX 随选视频代码

- 在购买 DivX 视频并在此播放机上播放之前，请先使用 DivX VOD 代码在 [www.divx.com](http://www.divx.com) 上注册此播放机。
- 显示 DivX VOD 代码：按 **▲**，然后选择 **[设置] > [高级] > [DivX® 随选视讯]**。

### DivX 字幕

- 按 **SUBTITLE** 选择语言。
- 如果字幕显示不正确，请更改支持 DivX 字幕的字符集。选择字符集：按 **≡**，然后选择 **[字符集]**。

| 字符集            | 语言  |
|----------------|---|
| <b>[标准]</b>    | 英语、阿尔巴尼亚语、丹麦语、荷兰语、芬兰语、法语、盖尔语、德语、意大利语、库尔德语（拉丁语）、挪威语、葡萄牙语、西班牙语、瑞典语和土耳其语 |
| <b>[中文]</b>    | 简体中文  |
| <b>[繁体中文语]</b> | 繁体中文  |
| <b>[韩语]</b>    | 英语和韩语   |

### ≡ 注

- 要从 USB 存储设备播放受 DivX DRM 保护的的文件，请通过 HDMI 将此播放机连接至电视。
- 要使用字幕，请确保字幕文件与 DivX 视频文件同名。例如，如果 DivX 视频文件名为“movie.avi”，则将字幕文件另存为“movie.srt”或“movie.sub”。
- 本播放机可以播放以下格式的字幕文件：.srt、.sub、.txt、.ssa 和 .smi。

## RMVB 或 RM 文件

您可以从光盘或 USB 存储设备播放 RMVB 或 RM 文件。

Real Media Variable Bitrate (RMVB) 和 RealMedia (RM) 文件均包含音频和视频。您可以将 RMVB 或 RM 文件从您的电脑复制到可刻录的光盘或 USB 存储设备。然后从本播放机播放。

### ≡ 注

- 确保文件扩展名必须为“.RMVB”或“.RM”。

---

## 播放音乐幻灯片

同时播放音乐和图片，以创建音乐幻灯片。

- 1 从光盘或连接的 USB 存储设备中，播放一个音乐文件。
- 2 按 **↵**，然后转至图片文件夹。
- 3 从同一光盘或 USB 中选择一个图片，然后按 **OK** 开始幻灯片放映。
- 4 按 **■** 停止幻灯片放映。
- 5 再次按 **■** 停止音乐播放。

---

## 蓝光光盘上的 BonusView 功能

在小屏幕窗口中观看特殊内容（如解说）。  
此功能仅适用于与 BonusView（也叫画中画）兼容的蓝光光盘。

- 1 播放时，按 **≡**。  
↳ 将显示选项菜单。
- 2 选择 **[PIP 选择] > [PIP]**，然后按 **OK**。  
↳ 画中画选项 [1]/[2] 因视频内容而异。  
↳ 将显示辅助视频窗口。
- 3 选择 **[第二音频语言]** 或 **[第二字幕语言]**，然后按 **OK**。

---

## 蓝光光盘上的 BD-Live 功能

访问独家在线内容，例如电影预告片、游戏、铃声及其他花絮内容。  
此功能仅适用于支持 BD-Live 的蓝光光盘。

- 1 准备互联网连接和设置网络（请参阅“设置网络”）。
- 2 将 USB 存储设备连接至本播放机上的 **↔ (USB)** 接口。
  - USB 存储设备用于存储下载的 BD-Live 内容。
  - 如果您通过 Wi-Fi USB 适配器（单独出售）将本播放机连接至互联网，请将 USB 集线器（未随附）连接至本播放机，以便使用多个 USB 端口。
  - 要删除以前下载到 USB 存储设备上的 BD-Live 内容以便释放内存，请按 **⬆** 并选择 **[设置] > [高级] > [清除存储]**。
- 3 播放支持 BD-Live 的光盘。
- 4 在光盘菜单上，选择 BD-Live 图标，然后按 **OK**。  
↳ BD-Live 开始加载。加载时间因光盘和互联网的连接情况而异。
- 5 在 BD-Live 界面上，选择要访问的项目。



 注

- BD-Live 服务因光盘和国家/地区而异。
- 使用 BD-Live 功能时，内容提供商可访问光盘和本播放机中的数据
- 请使用可用空间至少达 1GB 的 USB 存储设备存储下载的文件。

## 播放蓝光 3D 视频

在使用之前，请确保：

- 电视兼容于 3D 并通过 HDMI 连接至此播放机
- 光盘为蓝光 3D 光盘
- 拥有兼容于电视的 3D 眼镜。

- 1 确保 3D 输出已打开：按 ，然后选择 [设置] > [视频] > [观看 3D 视频] > [自动]。
- 2 播放蓝光 3D 视频。
- 3 戴上 3D 眼镜体验 3D 效果。
  - 要以 2D 模式播放 3D 视频，请关闭蓝光 3D 输出（按 ，然后选择 [设置] > [视频] > [观看 3D 视频] > [关]）。

## 设置网络

将本播放机连接至互联网以访问以下服务：

- **BD-Live**：访问在线花絮内容（适用于支持 BD-Live 的蓝光光盘）
- **更新软件**：通过互联网更新本播放机的软件。

 注

- 对于无线连接，您需要使用可选购的 Philips Wi-Fi USB 适配器（名为 WUB1110）。
- Wi-Fi USB 适配器 (WUB1110) 未随附。要购买此适配器，请访问 [shop.philips.com](http://shop.philips.com)。如果您的国家/地区没有 Philips 在线商店，请联系您所在国家/地区的 Philips 客户服务。有关联系信息，请转到 [www.philips.com/support](http://www.philips.com/support)。

- 1 通过有线（以太网）或无线连接将本播放机连接至互联网。
  - 对于有线连接，请将网络线缆（未随附）连接至本播放机后面板上的 LAN 端口。
  - 对于 Wi-Fi，请将飞利浦 Wi-Fi USB 适配器（名为 WUB1110）连接至本播放机前面板上的  (USB) 接口。

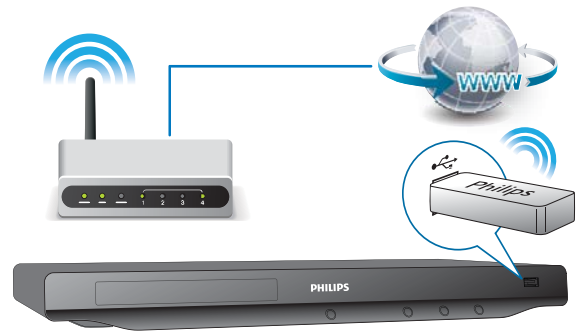
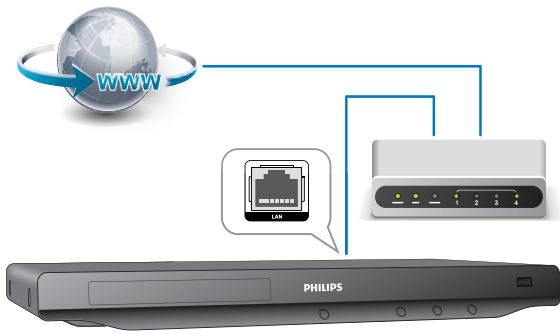

## 2 执行网络安装。

- 1) 按 **▲**。
- 2) 选择 **[设置]**，然后按 **OK**。
- 3) 选择 **[网络]** > **[网络安装]**，然后按 **OK**。
- 4) 请按照电视屏幕上的说明完成安装。如有必要，请使用遥控器上的字母数字按钮输入密码。

### **!** 注意

- 连接至网络之前，请先熟悉网络路由器及联网原则的知识。必要时，请阅读网络组件随附的文档。Philips 对数据丢失、毁坏或损坏概不负责。

## 卡拉 OK

- 1 将麦克风（未随附）连接至播放机上的 **MIC** 接口。
- 2 按 **▲** 显示主菜单。
- 3 选择 **[设置]** > **[音频]** > **[卡拉 OK]**，然后按 **OK**。  
↳ 将显示卡拉 OK 菜单。
- 4 选择 **[麦克风]** > **[开]**，然后按 **OK** 打开麦克风声音输出。
- 5 播放光盘，然后对着麦克风唱歌。  
**通过卡拉 OK 菜单设置卡拉 OK**
  - **[麦克风]**：打开或关闭麦克风声音输出。
  - **[麦克风音量]**：更改麦克风音量。
  - **[回声]**：更改回音级别。
  - **[基调]**：根据您的嗓音更改音高级别。

### 卡拉 OK 原声

反复按遥控器上的 **AUDIO** 直至关闭原声。  
完全取消原声取决于所使用的光盘。



---

## 使用 Philips EasyLink

本播放机支持使用 HDMI CEC（消费电子控制）协议的 Philips EasyLink 功能。您可以使用单个遥控器来控制通过 HDMI 连接的 EasyLink 兼容设备。Philips 不保证本产品可与所有 HDMI CEC 设备进行互操作。

- 1 通过 HDMI 连接 HDMI CEC 兼容设备，然后打开电视及其他设备上的 HDMI CEC 操作（有关详情，请参阅电视或其他设备的用户手册）。
- 2 按 **▲**。
- 3 选择 **[设置]** > **[EasyLink]**。
- 4 选择 **[开]**（对于以下选项：**[EasyLink]**、**[单键式播放]** 和 **[单键式待机]**）。  
↳ EasyLink 功能将打开。

---

### 单键式播放

在此播放机上播放光盘时，电视将自动切换至正确的视频输入源。

---

### 单键式待机

使用其自带的遥控器使连接的设备（如电视）进入待机状态时，本播放机也会自动进入待机模式。

---

# 3 更改设置

本部分帮助您更改本播放机的设置。

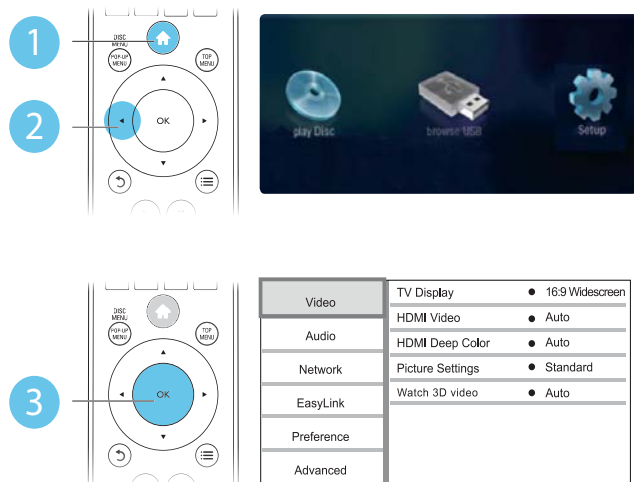

## 注

- 不能更改呈灰色显示的菜单选项。
- 要返回上一个菜单，请按 **↶**。要退出菜单，请按 **⏠**。

## 画面

- 1 按 **⏠**。
- 2 选择 **[设置] > [视频]** 访问视频设置选项。
  - **[电视屏幕显示]**: 选择适合电视屏幕的画面显示格式。
  - **[HDMI 视频]**: 选择 HDMI 视频分辨率。
  - **[HDMI Deep Color]**: 如果是以 Deep Color 模式录制的视频内容，并且电视支持此功能，则将显示出色差和色调更为丰富的色彩。
  - **[图像设置]**: 选择预设色彩设置。
  - **[观看 3D 视频]**: 在播放蓝光 3D 光盘时设为 3D 或 2D 输出。播放机必须通过 HDMI 连接至 3D 电视。

 注

- 如果更改设置，请确保电视支持新设置。
- 对于与 HDMI 相关的设置，必须通过 HDMI 连接电视。
- 对于复合连接（通过 **VIDEO** 接口），请在 [**HDMI 视频**] 下选择 480i/576i 或 480p/576p 的视频分辨率，以支持视频输出。

---

## 声音

1 按 。

2 选择 [**设置**] > [**音频**] 访问音频设置选项。

- [**夜间模式**]：选择安静或全动态音效。夜间模式可降低响亮声音的音量，并提高柔和声音（如讲话）的音量。
- [**Neo 6**]：启用或禁用从 2.0 声道音频转换过来的环绕音效。
- [**HDMI 音频**]：在本播放机通过 HDMI 连接的情况下设置 HDMI 音频格式。
- [**数字音频**]：在本播放机通过数字接口（同轴）连接的情况下为声音输出选择音频格式。
- [**PCM 下采样**]：在本播放机通过数字接口（同轴）连接的情况下为 PCM 音频输出设置采样率。
- [**卡拉 OK**]：设置卡拉 OK 功能（请参阅“使用您的蓝光光盘/DVD 播放机” > “卡拉 OK”）。

 注

- 对于与 HDMI 相关的设置，必须通过 HDMI 连接电视。
- 夜间模式仅适用于杜比编码的 DVD 和蓝光光盘。

---

## 网络（安装、状态...）

1 按 。

2 选择 [**设置**] > [**网络**] 访问网络设置选项。

- [**网络安装**]：开始有线或无线安装以使网络工作。
- [**查看网络设置**]：显示当前的网络状态。
- [**查看无线设置**]：显示当前的 Wi-Fi 状态。

---

## 首选项（语言、家长控制...）

1 按 。

2 选择 [**设置**] > [**首选项**] 访问首选项设置选项。

- **[菜单语言]**: 选择屏上显示菜单语言。
- **[音频]**: 选择视频的音频语言。
- **[字幕]**: 选择视频的字幕语言。
- **[光盘菜单]**: 选择视频光盘的菜单语言。
- **[儿童锁]**: 限制访问按等级编码的光盘。输入“0000”访问限制选项。要不分等级播放所有光盘，请选择级别“8”。
- **[屏幕保护]**: 启用或禁用屏幕保护模式。如果启用该功能，则屏幕将在 10 分钟不活动状态（例如，处于暂停或停止模式）后进入闲置模式。
- **[自动字幕移动]**: 启用或禁用字幕移动。如果启用该功能，字幕位置将自动更改以适应电视屏幕（此功能仅适用于部分飞利浦电视）。
- **[更改密码]**: 设置或更改密码以播放受限制的光盘。如果没有设置密码或者您忘记了密码，请输入“0000”。
- **[显示面板]**: 更改播放机显示面板的亮度。
- **[自动待机]**: 启用或禁用自动待机功能。如果启用该功能，播放机将在 30 分钟不活动状态（例如，处于暂停或停止模式）后切换至待机模式。
- **[VCD PBC]**: 显示或跳过 VCD 和 SVCD 的内容菜单。



### 注

- 如果首选的语言不适用于光盘语言、音频或字幕，则可从菜单选项中选择 **[其它]** 并输入 4 位语言代码（该代码可在用户手册背面找到）。
- 如果您选择的语言不适用于光盘，本播放机将使用默认的光盘语言。

## 高级选项（BD-Live 安全性、清除存储...）

- 1 按 **▲**。
- 2 选择 **[设置]** > **[高级]** 访问高级设置选项。
  - **[BD-Live 安全]**: 限制或允许访问 BD-Live（仅限于非商用、用户创建的 BD-Live 光盘）。
  - **[软件更新]**: 选择该选项从网络或 USB 存储设备更新软件。
  - **[清除存储]**: 删除以前下载到 USB 存储设备上的 BD-Live 内容。自动创建“BUDA”文件夹，以存储下载的 BD-Live 内容。
  - **[DivX® 随选视讯]**: 显示本播放机的 DivX® 注册码或注销码。
  - **[版本信息]**: 显示本播放机的软件版本。
  - **[恢复默认设置]**: 将本播放机重置为出厂时的默认设置。



### 注

- 您将不能限制商用蓝光光盘的互联网接入。
- 在购买 DivX 视频并在此播放机上播放之前，请先使用 DivX VOD 代码在 [www.divx.com](http://www.divx.com) 上注册此播放机。
- 不能将家长控制设置重置为默认值。

## 4 更新软件

更新本播放机的软件之前，请先检查当前的软件版本：

- 按 **▲**，然后选择 **[设置] > [高级] > [版本信息]**，再按 **OK**。

---

### 通过互联网更新软件

- 1 将播放机连接至互联网（请参阅“设置网络”）。
- 2 按 **▲**，然后选择 **[设置]**。
- 3 选择 **[高级] > [软件更新] > [网络]**。  
↳ 如果检测到升级媒体，将提示您开始更新操作。
- 4 按照电视屏幕上的说明更新软件。  
↳ 软件更新完成后，本播放机将自动关闭并重新打开。

---

### 通过 USB 设备更新软件

- 1 在 [www.philips.com/support](http://www.philips.com/support) 上检查最新的软件版本。
  - 搜索您的型号，然后单击“软件和驱动程序”。
- 2 将软件下载到 USB 存储设备上。
  - ① 解压缩下载文件，确保解压缩文件夹名为“UPG\_ALL”。
  - ② 将“UPG\_ALL”文件夹放在根目录中。
- 3 将 USB 存储设备连接至本播放机上的 **↔** (USB) 接口。
- 4 按 **▲**，然后选择 **[设置]**。
- 5 选择 **[高级] > [软件更新] > [USB]**。  
↳ 如果检测到升级媒体，将提示您开始更新操作。
- 6 按照电视屏幕上的说明更新软件。  
↳ 软件更新完成后，本播放机将自动关闭并重新打开。

#### **!** 注意

- 在软件更新过程中，请勿关闭电源或移除 USB 存储设备，因为这样做可能会损坏本播放机。



# 5 规格

## 注

- 规格随时可能变更，恕不另行通知。

## 区域码

本播放机可以使用以下区域码播放光盘。

| DVD   | Blu-ray   | 国家/地区 |
|---|---|-------|
|  |  | 中国大陆  |

## 可播放的介质

- BD-Video, BD 3D
- DVD-Video、DVD+R/+RW、DVD-R/-RW、DVD+R/-R DL (双层)
- VCD/SVCD
- 音频 CD、CD-R/CD-RW、MP3 媒体、WMA 媒体、JPEG 文件
- DivX (Ultra)/DivX Plus HD 媒体、MKV 媒体
- USB 存储设备

## 文件格式

- 视频: .avi、.divx、.mp4、.mkv、.rmvb、.rm
- 音频: .mp3、.wma、.wav
- 图片: .jpg、.gif、.png

## 视频

- 信号制式: PAL / NTSC
- 复合视频输出: 1 Vp-p (75 欧姆)
- HDMI 输出 480p、576p、720p、1080i、1080p、1080p/24

## 音频

- 2 声道模拟输出
  - 前置左右声道: 2 Vrms (> 1 千欧)
- 数字输出: 0.5 Vp-p (75 欧姆)
  - 同轴电缆
- HDMI 输出
- 采样频率:
  - MP3: 32 千赫、44.1 千赫、48 千赫
  - WMA: 44.1 千赫、48 千赫
- 固定比特率:
  - MP3: 112 kbps - 320 kbps
  - WMA: 48 kbps - 192 kbps

## USB

- 兼容性：高速 USB (2.0)
- 类别支持：USB 海量存储类 (UMS)
- 文件系统：FAT16、FAT32
- 支持硬盘（便携式硬盘）：可能需要外接电源。

## 主装置

- 额定电源：交流约 100-240 伏，50/60 赫兹
- 功耗：18 瓦
- 待机模式下的功耗：< 0.5 瓦
- 尺寸（宽 × 高 × 厚）：435 × 41 × 195.5（毫米）
- 净重：1.4 千克

## 提供的附件

- 遥控器和电池
- 用户手册

## 激光规格

- 激光类型（二极管）：AlGaInN (BD), AlGaInP (DVD/CD)
- 波长：405+7nm/-7nm (BD)、655+10nm/-10nm (DVD)、790+10/-20nm (CD)
- 输出功率：1mW (BD)、0.26mW (DVD)、0.3mW (CD)

# 6 故障种类和处理方法

## 警告

- 存在触电危险。切勿拆下本播放机的外壳。

为保持保修的有效性，切勿尝试自行维修本播放机。

如果在使用本播放机时遇到问题，请在请求服务之前检查以下事项。如果仍遇到问题，请在 [www.philips.com/welcome](http://www.philips.com/welcome) 页面上注册您的播放机并获得支持。

如果您与 Philips 联系，将询问您该播放机的型号和序列号。型号和序列号可以在本播放机的背面找到。请在此处填写型号：

型号 \_\_\_\_\_

序列号 \_\_\_\_\_

---

## 主装置

本播放机上的按钮不起作用。

- 将本播放机的电源断开几分钟，然后重新连接。

---

## 画面

无画面。

- 确保电视已切换至适合本播放机的正确输入来源。
- 对于本播放机上连接电视的复合连接（通过 **VIDEO** 接口），请在 **[HDMI 视频]** 下选择 480i/576i 或 480p/576p 的视频分辨率，以支持视频输出。

使用 HDMI 连接时无图像。

- 确保 HDMI 电缆没有故障。如果有故障，请用新的 HDMI 电缆进行更换。
- 在在遥控器上按 **▲**，然后按“731”（数字键），即可恢复画面显示。或者等待 10 秒钟后自动恢复。
- 如果通过 HDMI 电缆将此播放机连接至未授权的播放设备，则可能无法输出音频和视频信号。

光盘不播放高清视频。

- 确保光盘中包含有高清视频。
- 确保电视支持高清视频。



## 声音

### 电视无音频输出。

- 确保已将音频电缆连接至电视的音频输入插孔。
- 确保电视已切换至适合本播放机的正确输入来源。

### 外部音频设备（家庭影院或功放器）的扬声器没有音频输出。

- 确保已将音频电缆连接至音频设备的音频输入插孔。
- 将外部音频设备切换至正确的音频输入来源。

### HDMI 连接无声音。

- 如果连接的设备不符合 HDCP 标准或仅兼容 DVI，则您可能无法听到 HDMI 输出的声音。

### 没有画中画功能的辅助音频输出。

- 选择 **[位流]**（位于 **[HDMI 音频]** 或 **[数字音频]** 菜单下）时，画中画功能的辅助音等交互音将被静音。取消选择 **[位流]**。

### 卡拉 OK 的麦克风没有声音。

- 打开麦克风输出：按 **▲**，然后选择 **[设置] > [音频] > [卡拉 OK] > [麦克风] > [开]**。

## 播放

### 无法播放光盘。

- 清洁光盘。
- 确保光盘已正确加载。
- 确保本播放机支持该光盘。请参阅“产品规格”。
- 确保此播放机支持 DVD 或 BD 区域码。
- 对于 DVD±RW 或 DVD±R，应确保光盘已结定。

### 不能播放 DivX 视频文件。

- 确保 DivX 视频文件是完整的。
- 确保视频文件扩展名正确。
- 要从 USB 存储设备播放受 DivX DRM 保护的文件，请通过 HDMI 将此播放机连接至电视。

### 不能正确显示 DivX 字幕。

- 确保字幕文件与 DivX 视频文件同名。
- 确保字幕文件具有本播放机支持的扩展名（.srt、.sub、.txt、.ssa 或 .smi）。

### 无法读取已连接 USB 存储设备的内容。

- 确保 USB 存储设备的格式与本播放机兼容。
- 确保本播放机支持 USB 存储设备上的文件系统。
- 对于便携式硬盘，可能需要外接电源。

### 电视上显示“**No entry**”（无输入）或“**x**”字样。

- 无法进行操作。

### EasyLink 功能不起作用。

- 确保本播放机连接到了 Philips 品牌的 EasyLink 电视并且打开了 EasyLink 选项（请选择“使用您的蓝光光盘/DVD 播放机” > “使用 Philips EasyLink”）。

### 无法访问 BD-Live 功能。

- 确保本播放机连接到了网络（请参阅“使用您的蓝光光盘/DVD 播放机” > “设置网络”）。
- 请确保完成了网络安装（请参阅“使用您的蓝光光盘/DVD 播放机” > “设置网络”）。
- 确保蓝光光盘支持 BD-Live 功能。
- 清除存储空间（请参阅“更改设置” > “高级选项（BD-Live 安全性、清除存储...）”）。

---

## 网络

### 没有找到无线网络或失真。

- 请确保正确连接了网络（请参阅“使用您的蓝光光盘/DVD 播放机” > “设置网络”）。
- 请确保完成了网络安装（请参阅“使用您的蓝光光盘/DVD 播放机” > “设置网络”）。
- 确保无线网络不受微波炉、DECT 手机或附近其他 Wi-Fi 设备的干扰。
- 如果无线网络工作不正常，请尝试安装有线网络（请参阅“使用您的蓝光光盘/DVD 播放机” > “设置网络”）。

---

## 3D 视频

### 看不到 3D 效果

- 确保已打开 3D 输出（请参阅“使用您的蓝光光盘/DVD 播放机” > “播放蓝光 3D 视频”）。
- 确保当前播放的光盘标题兼容于蓝光 3D。
- 确保电视兼容于 3D 和 HDMI，并且电视设置为 3D 模式（请参阅电视的用户手册）。
- 确保 3D 眼镜启动（请参阅电视的用户手册）。

# 7 安全和重要注意事项

在使用本蓝光光盘/DVD 播放机之前，请先阅读并理解所有说明。因未遵守说明而造成的损坏不在保修范围内。

## 安全

### 小心触电或发生火灾!

- 切勿让本产品及配件与雨或水接触。切勿将液体容器（如花瓶）置于产品旁边。如果有液体溅到本产品表面或内部，请立即断开其电源。请与 Philips 客户服务中心联系，对产品进行检查后再行使用。
- 切勿将本产品及配件放置在靠近明火或其它热源的地方，包括阳光直射处。
- 切勿将物体插入本产品的通风槽或其它开口。
- 将电源插头或设备耦合器用作断电设备时，该断电设备应可以随时使用。
- 在雷电天气之前，应断开本产品的电源。
- 断开电源线时，应始终握住插头，而不能拉电缆。

### 小心短路或起火!

- 在将本产品连接到电源插座上之前，请确保电源电压与产品背面或底部印刷的电压值相匹配。如果电压不同，切勿将产品连接到电源插座上。

### 小心受伤或损坏本产品!

- 该设备打开时，存在可见及不可见的激光辐射。避免直视激光束。
- 切勿触摸光盘仓内的光盘光学镜头。
- 切勿将本产品或任何物体放在电源线或其它电子设备上面。
- 如果在低于 5°C 的温度下运送了本产品，请先拆开产品的包装并等待其温度达到室温，再将其连接至电源插座。

### 小心过热!

- 切勿将本产品安装在封闭的空间内。务必在产品周围留出至少 4 英寸的空间以便通风。确保窗帘或其它物体不会遮挡产品上的通风槽。

### 小心污染!

- 请勿混合使用电池（旧电池与新电池或碳电池与碱性电池，等等）。
- 如果电池电量耗尽或遥控器长时间不用，请取下电池。
- 电池含有化学物质，因此应适当地进行处理。

### 吞咽电池的危險!

- 产品/遥控器可能包含纽扣式电池，容易被吞咽。
- 始终将电池放在儿童接触不到的地方!



---

## 3D 健康警告

- 如果您或您的家人有癫痫或光敏感病史，请在接触闪烁光源、快速画面切换或 3D 视觉效果之前，咨询专业医生。
- 为免引起头昏眼花、头痛或晕头转向等不适，我们建议您不能观看 3D 太长时间。如果您感到不适，请停止观看 3D，并且不能立即从事任何具有潜在危险的行为（例如驾车），直到症状消失。如果症状仍然存在，则必须先咨询医生的意见，以确定能否继续观看 3D。
- 在观看 3D 期间，家长应监督其子女，确保他们没有遇到上述任何不适。不建议 6 岁以下的儿童观看 3D，因为他们的视觉系统尚未发育健全。

---

## 爱护产品

- 切勿将光盘以外的任何物体插入光盘仓中。
- 切勿将变形或破裂的光盘插入光盘仓中。
- 如果长时间不使用本产品，请将光盘从光盘仓中取出。
- 只能用微细纤维清洁布清洁本产品。

---

## 爱护环境



本产品采用可回收利用的高性能材料和组件制造而成。切勿将本产品与其它生活垃圾一起处理。请自行了解当地关于分类收集电子、电气产品及电池的规定。正确弃置这些产品有助于避免对环境和人体健康造成潜在的负面影响。

本产品所含的电池不能与一般的生活垃圾一同弃置。请自行了解当地关于分类收集电池的规定。正确弃置电池有助于避免对环境和人类健康造成潜在的负面影响。

关于您所在地区回收中心的更多信息，请访问 [www.recycle.philips.com](http://www.recycle.philips.com)。

---

## 版权



Be responsible  
Respect copyrights

本商品采用版权保护技术，受美国专利和 Rovi Corporation 的其它知识产权保护。禁止反向工程或反汇编。

### 开放源代码软件

Philips Electronics Hong Kong Ltd. 特此承诺，若用户有此要求，并出具相应的许可证，我们将向其提供本产品中所用的受版权保护的开源软件包的全部源代码副本。

本承诺自任何人购买本产品并收到此信息后三年内有效。要获得源代码，请联系 [contact.open.source@philips.com](mailto:contact.open.source@philips.com)。如果您不想使用电子邮件，或者在寄到此电子邮件地址后一周内没有收到确认回执，请写信至“Open Source Team, Philips Intellectual Property & Standards, P.O. Box 220, 5600 AE Eindhoven, The Netherlands.”如果您没有及时收到确认函件，请发送电子邮件到上述电子邮件地址。

### 最终用户须知:

使用此带 RealNetworks 软件和服务的产品，即表示最终用户同意遵守 REALNETWORKS, INC. 的以下条款:

- 根据 RealNetworks EULA 的条款，最终用户只能将本软件用于个人、非商业的目的。
- 最终用户不得修改、翻译、逆向工程、反编译或分解，或采用其他方式发现源代码，也不得复制 Real 格式客户端代码的功能，除非有适用的法律明确禁止这些限制。
- RealNetworks Inc. 声明，所有其他明示或暗示的保证，包括但不限于任何有关适销性以及特殊用途适用性的暗示保证或条件，均不得代替本协议中规定的所有保证和条件；对于任何间接、特殊、偶然或继发性损害，包括但不限于利润损失，RealNetworks Inc. 概不负责。

## 商标



“Blu-ray”、“Blu-ray Disc”、“Blu-ray Disc”徽标、“Blu-ray 3D”和“Blu-ray 3D”徽标是 Blu-ray Disc Association 的商标。



HDMI、HDMI 徽标和高清多媒体接口是 HDMI licensing LLC 在美国及其他国家或地区的商标或注册商标。



在杜比实验室许可下制造。“Dolby”和双 D 符号是杜比实验室的商标。



在美国 第 5,451,942、5,956,674、5,974,380、5,978,762、6,226,616、6,487,535、7,212,872、7,333,929、7,392,195、7,272,567 号 专利和其它已注册及正在申请的美国和世界专利许可下制造。DTS 和 Symbol 是 DTS, Inc. 的注册商标。DTS-HD、DTS-HD Master Audio 和 DTS 徽标是 DTS, Inc. 的商标。产品包括软件。  
? DTS, Inc. 保留所有权利。



关于 DivX 视频: DivX® 是由 DivX, Inc. 创建的一种数字视频格式。这是由 DivX Certified® 正式认证的可播放 DivX 视频的设备。更多有关 DivX 视频以及将文件转换成 DivX 视频格式的软件工具的信息, 请访问 [divx.com](http://divx.com)。

关于 DivX 随选视频: 这款 DivX Certified® 设备必须注册, 才能播放付费的 DivX 视频点播 (VOD) 影片。要获得注册码, 请在设备设置菜单中找到 DivX VOD 部分。有关如何完成注册的更多信息, 请转到 [vod.divx.com](http://vod.divx.com)。

DivX®、DivX Certified®、DivX Plus™ HD 及相关徽标是 DivX, Inc. 的注册商标, 并在授权下使用。

通过 DivX Certified® 认证, 可以播放 DivX® 和 DivX Plus™ HD (H.264/MKV) 视频, 最高分辨率可达 1080p 高清, 包括付费内容。



**BONUSVIEW™**

“BD LIVE”和“BONUSVIEW”是蓝光光盘协会的商标。



“DVD Video”是 DVD Format/Logo Licensing Corporation 的商标。



Real RMVB 徽标是 RealNetworks, Inc. 的商标或注册商标。



Java 及所有其它的 Java 商标及徽标是 Sun Microsystems, Inc. 在美国和/或其它国家/地区的商标或注册商标。

| 部件名称<br>Name of the Parts  | 有毒有害物质或元素<br>Hazardous/Toxic Substance |                    |                    |                      |               |                 |
|--|--|--------------------|--------------------|----------------------|---------------|-----------------|
|  | 铅<br>(Pb, Lead)                        | 汞 (Hg,<br>Mercury) | 镉 (Cd,<br>Cadmium) | 六价铬<br>(Chromium 6+) | 多溴联苯<br>(PBB) | 多溴二苯醚<br>(PBDE) |
| Housing<br>外壳  | O                                      | O                  | O                  | O                    | O             | O               |
| DVD loader<br>DVD 光盒   | X                                      | O                  | O                  | O                    | O             | O               |
| PWBs<br>电路板组件  | X                                      | O                  | O                  | O                    | O             | O               |
| Accessories<br>(Remote control &<br>cables)<br>附件 (遥控器,<br>电源线, 连接线) | X                                      | O                  | O                  | O                    | O             | O               |
| Batteries in<br>Remote Control<br>(ZnC)<br>遥控器电池                     | X                                      | O                  | O                  | O                    | O             | O               |

O: 表示该有毒有害物质在该部件所有均质材料中的含量均在SJ/T11363 - 2006 标准规定的限量要求以下。  
O: Indicates that this toxic or hazardous substance contained in all of the homogeneous materials for this part is below the limit requirement in SJ/T11363 - 2006.

X: 表示该有毒有害物质至少在该部件的某一均质材料中的含量超出SJ/T11363 - 2006 标准规定的限量要求。  
X: Indicates that this toxic or hazardous substance contained in at least one of the homogeneous materials used for this part is above the limit requirement in SJ/T11363 - 2006.



### 环保使用期限 Environmental Protection Use Period

此标识指期限（十年），电子信息产品中含有的有毒有害物质或元素在正常使用的条件下不会发生外泄或突变，用户使用该电子信息产品不会对环境造成严重污染或对其人身、财产造成严重损害的期限。

This logo refers to the period ( 10 years ) during which the toxic or hazardous substances or elements contained in electronic information products will not leak or mutate so that the use of these [substances or elements] will not result in any severe environmental pollution, any bodily injury or damage to any assets.

### 电池标识 Battery labeling logo



### 环保使用期限 Environmental Protection Use Period

此标识指期限（五年），电池中含有的有毒有害物质或元素在正常使用的条件下不会发生外泄或突变，用户使用该电池产品不会对环境造成严重污染或对其人身、财产造成严重损害的期限。

This logo refers to the period ( 5 years ) during which the toxic or hazardous substances or elements contained in the **battery** will not leak or mutate so that the use of these [substances or elements] will not result in any severe environmental pollution, any bodily injury or damage to any assets.



## Language Code

|                             |      |                             |      |                       |      |
|-----------------------------|------|-----------------------------|------|-----------------------|------|
| Abkhazian                   | 6566 | Inupiaq                     | 7375 | Pushto                | 8083 |
| Afar                        | 6565 | Irish                       | 7165 | Russian               | 8285 |
| Afrikaans                   | 6570 | Íslenska                    | 7383 | Quechua               | 8185 |
| Amharic                     | 6577 | Italiano                    | 7384 | Raeto-Romance         | 8277 |
| Arabic                      | 6582 | Ivrit                       | 7269 | Romanian              | 8279 |
| Armenian                    | 7289 | Japanese                    | 7465 | Rundi                 | 8278 |
| Assamese                    | 6583 | Javanese                    | 7486 | Samoan                | 8377 |
| Avestan                     | 6569 | Kalaallisut                 | 7576 | Sango                 | 8371 |
| Aymara                      | 6589 | Kannada                     | 7578 | Sanskrit              | 8365 |
| Azerhijani                  | 6590 | Kashmiri                    | 7583 | Sardinian             | 8367 |
| Bahasa Melayu               | 7783 | Kazakh                      | 7575 | Serbian               | 8382 |
| Bashkir                     | 6665 | Kernewek                    | 7587 | Shona                 | 8378 |
| Belarusian                  | 6669 | Khmer                       | 7577 | Shqip                 | 8381 |
| Bengali                     | 6678 | Kinyarwanda                 | 8287 | Sindhi                | 8368 |
| Bihari                      | 6672 | Kirghiz                     | 7589 | Sinhalese             | 8373 |
| Bislama                     | 6673 | Komi                        | 7586 | Slovensky             | 8373 |
| Bokmål, Norwegian           | 7866 | Korean                      | 7579 | Slovenian             | 8376 |
| Bosanski                    | 6683 | Kuanyama; Kwanyama          | 7574 | Somali                | 8379 |
| Brezhoneg                   | 6682 | Kurdish                     | 7585 | Sotho; Southern       | 8384 |
| Bulgarian                   | 6671 | Lao                         | 7679 | South Ndebele         | 7882 |
| Burmese                     | 7789 | Latina                      | 7665 | Sundanese             | 8385 |
| Castellano, Español         | 6983 | Latvian                     | 7686 | Suomi                 | 7073 |
| Catalán                     | 6765 | Letzeburgesch;              | 7666 | Swahili               | 8387 |
| Chamorro                    | 6772 | Limburgan; Limburger        | 7673 | Swati                 | 8383 |
| Chechen                     | 6769 | Lingala                     | 7678 | Svenska               | 8386 |
| Chewa; Chichewa; Nyanja     | 7889 | Lithuanian                  | 7684 | Tagalog               | 8476 |
| 中文                          | 9072 | Luxembourgish;              | 7666 | Tahitian              | 8489 |
| Chuang; Zhuang              | 9065 | Macedonian                  | 7775 | Tajik                 | 8471 |
| Church Slavik; Slavonic     | 6785 | Malagasy                    | 7771 | Tamil                 | 8465 |
| Chuvash                     | 6786 | Magyar                      | 7285 | Tatar                 | 8484 |
| Corsican                    | 6779 | Malayalam                   | 7776 | Telugu                | 8469 |
| Česky                       | 6783 | Maltese                     | 7784 | Thai                  | 8472 |
| Dansk                       | 6865 | Manx                        | 7186 | Tibetan               | 6679 |
| Deutsch                     | 6869 | Maori                       | 7773 | Tigrinya              | 8473 |
| Dzongkha                    | 6890 | Marathi                     | 7782 | Tonga (Tonga Islands) | 8479 |
| English                     | 6978 | Marshallese                 | 7772 | Tsonga                | 8483 |
| Esperanto                   | 6979 | Moldavian                   | 7779 | Tswana                | 8478 |
| Estonian                    | 6984 | Mongolian                   | 7778 | Türkçe                | 8482 |
| Euskara                     | 6985 | Nauru                       | 7865 | Turkmen               | 8475 |
| Ελληνικά                    | 6976 | Navaho; Navajo              | 7886 | Twi                   | 8487 |
| Faroese                     | 7079 | Ndebele, North              | 7868 | Uighur                | 8571 |
| Français                    | 7082 | Ndebele, South              | 7882 | Ukrainian             | 8575 |
| Frysk                       | 7089 | Ndonga                      | 7871 | Urdu                  | 8582 |
| Fijian                      | 7074 | Nederlands                  | 7876 | Uzbek                 | 8590 |
| Gaelic; Scottish Gaelic     | 7168 | Nepali                      | 7869 | Vietnamese            | 8673 |
| Gallegan                    | 7176 | Norsk                       | 7879 | Volapuk               | 8679 |
| Georgian                    | 7565 | Northern Sami               | 8369 | Walloon               | 8765 |
| Gikuyu; Kikuyu              | 7573 | North Ndebele               | 7868 | Welsh                 | 6789 |
| Guarani                     | 7178 | Norwegian Nynorsk;          | 7878 | Wolof                 | 8779 |
| Gujarati                    | 7185 | Occitan; Provençal          | 7967 | Xhosa                 | 8872 |
| Hausa                       | 7265 | Old Bulgarian; Old Slavonic | 6785 | Yiddish               | 8973 |
| Herero                      | 7290 | Oriya                       | 7982 | Yoruba                | 8979 |
| Hindi                       | 7273 | Oromo                       | 7977 | Zulu                  | 9085 |
| Hiri Motu                   | 7279 | Ossetian; Ossetic           | 7983 |                       |      |
| Hrwatski                    | 6779 | Pali                        | 8073 |                       |      |
| Ido                         | 7379 | Panjabi                     | 8065 |                       |      |
| Interlingua (International) | 7365 | Persian                     | 7065 |                       |      |
| Interlingue                 | 7365 | Polski                      | 8076 |                       |      |
| Inuktitut                   | 7385 | Português                   | 8084 |                       |      |





# License Texts and Acknowledgements for any open source software used in this Philips product

Instructions to obtain source code for this software can be found in the user manual, or in the supplied safety leaflet (if available).

## 1. U-boot

```
#
# (C) Copyright 2000 - 2008
# Wolfgang Denk, DENX Software Engineering, wd@denx.de.
#
# See file CREDITS for list of people who contributed to this
# project.
#
# This program is free software; you can redistribute it and/or
# modify it under the terms of the GNU General Public License as
# published by the Free Software Foundation; either version 2 of
# the License, or (at your option) any later version.
#
# This program is distributed in the hope that it will be useful,
# but WITHOUT ANY WARRANTY; without even the implied warranty of
# MERCHANTABILITY or FITNESS FOR A PARTICULAR PURPOSE. See the
# GNU General Public License for more details.
#
# You should have received a copy of the GNU General Public License
# along with this program; if not, write to the Free Software
# Foundation, Inc., 59 Temple Place, Suite 330, Boston,
# MA 02111-1307 USA
#
A copy of the GPL is included below at item 2.
```

## 2. Linux kernel

NOTE! This copyright does \*not\* cover user programs that use kernel services by normal system calls - this is merely considered normal use of the kernel, and does \*not\* fall under the heading of "derived work". Also note that the GPL below is copyrighted by the Free Software Foundation, but the instance of code that it refers to (the linux kernel) is copyrighted by me and others who actually wrote it. Also note that the only valid version of the GPL as far as the kernel is concerned is `_this_` particular version of the license (ie v2, not v2.2 or v3.x or whatever), unless explicitly otherwise stated.

-----  
Linus Torvalds

GNU GENERAL PUBLIC LICENSE

Version 2, June 1991

Copyright (C) 1989, 1991 Free Software Foundation, Inc.  
675 Mass Ave, Cambridge, MA 02139, USA

Everyone is permitted to copy and distribute verbatim copies of this license document, but changing it is not allowed.

### **Preamble**

The licenses for most software are designed to take away your freedom to share and change it. By contrast, the GNU General Public License is intended to guarantee your freedom to share and change free software--to make sure the software is free for all its users. This General Public License applies to most of the Free Software Foundation's software and to any other program whose authors commit to using it. (Some other Free Software Foundation software is covered by the GNU Library General Public License instead.) You can apply it to your programs, too.

When we speak of free software, we are referring to freedom, not price. Our General Public Licenses are designed to make sure that you have the freedom to distribute copies of free software (and charge for this service if you wish), that you receive source code or can get it if you want it, that you can change the software or use pieces of it in new free programs; and that you know you can do these things.

To protect your rights, we need to make restrictions that forbid anyone to deny you these rights or to ask you to surrender the rights. These restrictions translate to certain responsibilities for you if you distribute copies of the software, or if you modify it.

For example, if you distribute copies of such a program, whether gratis or for a fee, you must give the recipients all the rights that you have. You must make sure that they, too, receive or can get the source code. And you must show them these terms so they know their rights.

We protect your rights with two steps: (1) copyright the software, and (2) offer you this license which gives you legal permission to copy, distribute and/or modify the software.

Also, for each author's protection and ours, we want to make certain that everyone understands that there is no warranty for this free software. If the software is modified by someone else and passed on, we want its recipients to know that what they have is not the original, so that any problems introduced by others will not reflect on the original authors' reputations.

Finally, any free program is threatened constantly by software patents. We wish to avoid the danger that redistributors of a free program will individually obtain patent licenses, in effect making the program proprietary. To prevent this, we have made it clear that any patent must be licensed for everyone's free use or not licensed at all.

The precise terms and conditions for copying, distribution and modification follow.

## GNU GENERAL PUBLIC LICENSE TERMS AND CONDITIONS FOR COPYING, DISTRIBUTION AND MODIFICATION

0. This License applies to any program or other work which contains a notice placed by the copyright holder saying it may be distributed under the terms of this General Public License. The "Program", below, refers to any such program or work, and a "work based on the Program" means either the Program or any derivative work under copyright law: that is to say, a work containing the Program or a portion of it, either verbatim or with modifications and/or translated into another language. (Hereinafter, translation is included without limitation in the term "modification".) Each licensee is addressed as "you".  
Activities other than copying, distribution and modification are not covered by this License; they are outside its scope. The act of running the Program is not restricted, and the output from the Program is covered only if its contents constitute a work based on the Program (independent of having been made by running the Program). Whether that is true depends on what the Program does.
1. You may copy and distribute verbatim copies of the Program's source code as you receive it, in any medium, provided that you conspicuously and appropriately publish on each copy an appropriate copyright notice and disclaimer of warranty; keep intact all the notices that refer to this License and to the absence of any warranty; and give any other recipients of the Program a copy of this License along with the Program.  
You may charge a fee for the physical act of transferring a copy, and you may at your option offer warranty protection in exchange for a fee.
2. You may modify your copy or copies of the Program or any portion of it, thus forming a work based on the Program, and copy and distribute such modifications or work under the terms of Section 1 above, provided that you also meet all of these conditions:
  - a) You must cause the modified files to carry prominent notices stating that you changed the files and the date of any change.
  - b) You must cause any work that you distribute or publish, that in whole or in part contains or is derived from the Program or any part thereof, to be licensed as a whole at no charge to all third parties under the terms of this License.
  - c) If the modified program normally reads commands interactively when run, you must cause it, when started running for such interactive use in the most ordinary way, to print or display an announcement including an appropriate copyright notice and a notice that there is no warranty (or else, saying that you provide a warranty) and that users may redistribute the program under these conditions, and telling the user how to view a copy of this License. (Exception: if the Program itself is interactive but does not normally print such an announcement, your work based on the Program is not required to print an announcement.)

These requirements apply to the modified work as a whole. If identifiable sections of that work are not derived from the Program, and can be reasonably considered independent and separate works in themselves, then this License, and its terms, do not apply to those sections when you distribute them as separate works. But when you distribute the same sections as part of a whole which is a work based on the Program, the distribution of the whole must be on the terms of this License, whose permissions extend to the entire whole, and thus to each and every part regardless of who wrote it.

Thus, it is not the intent of this section to claim rights or contest your rights to work written entirely by you; rather, the intent is to exercise the right to control the distribution of derivative or collective works based on the Program.

In addition, mere aggregation of another work not based on the Program with the Program (or with a work based on the Program) on a volume of a storage or distribution medium does not bring the other work under the scope of this License.

3. You may copy and distribute the Program (or a work based on it, under Section 2) in object code or executable form under the terms of Sections 1 and 2 above provided that you also do one of the following:
  - a) Accompany it with the complete corresponding machine-readable source code, which must be distributed under the terms of Sections 1 and 2 above on a medium customarily used for software interchange; or,
  - b) Accompany it with a written offer, valid for at least three years, to give any third party, for a charge no more than your cost of physically performing source distribution, a complete machine-readable copy of the corresponding source code, to be distributed under the terms of Sections 1 and 2 above on a medium customarily used for software interchange; or,
  - c) Accompany it with the information you received as to the offer to distribute corresponding source code. (This alternative is allowed only for noncommercial distribution and only if you received the program in object code or executable form with such an offer, in accord with Subsection b above.)

The source code for a work means the preferred form of the work for making modifications to it. For an executable work, complete source code means all the source code for all modules it contains, plus any associated interface definition files, plus the scripts used to control compilation and installation of the executable. However, as a special exception, the source code distributed need not include anything that is normally distributed (in either source or binary form) with the major components (compiler, kernel, and so on) of the operating system on which the executable runs, unless that component itself accompanies the executable.

If distribution of executable or object code is made by offering access to copy from a designated place, then offering equivalent access to copy the source code from the same place counts as distribution of the source code, even though third parties are not compelled to copy the source along with the object code.

4. You may not copy, modify, sublicense, or distribute the Program except as expressly provided under this License. Any attempt otherwise to copy, modify, sublicense or distribute the Program is void, and will automatically terminate your rights under this License. However, parties who have received copies, or rights, from you under this License will not have their licenses terminated so long as such parties remain in full compliance.
5. You are not required to accept this License, since you have not signed it. However, nothing else grants you permission to modify or distribute the Program or its derivative works. These actions are prohibited by law if you do not accept this License. Therefore, by modifying or distributing the Program (or any work based on the Program), you indicate your acceptance of this License to do so, and all its terms and conditions for copying, distributing or modifying the Program or works based on it.
6. Each time you redistribute the Program (or any work based on the Program), the recipient automatically receives a license from the original licensor to copy, distribute or modify the Program subject to these terms and conditions. You may not impose any further restrictions on the recipients' exercise of the rights granted herein. You are not responsible for enforcing compliance by third parties to this License.
7. If, as a consequence of a court judgment or allegation of patent infringement or for any other reason (not limited to patent issues), conditions are imposed on you (whether by court order, agreement or otherwise) that contradict the conditions of this License, they do not excuse you from the conditions of this License. If you cannot distribute so as to satisfy simultaneously your obligations under this License and any other pertinent obligations, then as a consequence you may not distribute the Program at all. For example, if a patent license would not permit royalty-free redistribution of the Program by all those who receive copies directly or indirectly through you, then the only way you could satisfy both it and this License would be to refrain entirely from distribution of the Program.

If any portion of this section is held invalid or unenforceable under any particular circumstance, the balance of the section is intended to apply and the section as a whole is intended to apply in other circumstances.

It is not the purpose of this section to induce you to infringe any patents or other property right claims or to contest validity of any such claims; this section has the sole purpose of protecting the integrity of the free software distribution system, which is implemented by public license practices. Many people have made generous contributions to the wide range of software distributed through that system in reliance on consistent application of that system; it is up to the author/donor to decide if he or she is willing to distribute software through any other system and a licensee cannot impose that choice.

This section is intended to make thoroughly clear what is believed to be a consequence of the rest of this License.

8. If the distribution and/or use of the Program is restricted in certain countries either by patents or by copyrighted interfaces, the original copyright holder who places the Program under this License may add an explicit geographical distribution limitation excluding those countries, so that distribution is permitted only in or among countries not thus excluded. In such case, this License incorporates the limitation as if written in the body of this License.

9. The Free Software Foundation may publish revised and/or new versions of the General Public License from time to time. Such new versions will be similar in spirit to the present version, but may differ in detail to address new problems or concerns.

Each version is given a distinguishing version number. If the Program specifies a version number of this License which applies to it and "any later version", you have the option of following the terms and conditions either of that version or of any later version published by the Free Software Foundation. If the Program does not specify a version number of this License, you may choose any version ever published by the Free Software Foundation.

10. If you wish to incorporate parts of the Program into other free programs whose distribution conditions are different, write to the author to ask for permission. For software which is copyrighted by the Free Software Foundation, write to the Free Software Foundation; we sometimes make exceptions for this. Our decision will be guided by the two goals of preserving the free status of all derivatives of our free software and of promoting the sharing and reuse of software generally.

#### NO WARRANTY

11. BECAUSE THE PROGRAM IS LICENSED FREE OF CHARGE, THERE IS NO WARRANTY FOR THE PROGRAM, TO THE EXTENT PERMITTED BY APPLICABLE LAW. EXCEPT WHEN OTHERWISE STATED IN WRITING THE COPYRIGHT HOLDERS AND/OR OTHER PARTIES PROVIDE THE PROGRAM "AS IS" WITHOUT WARRANTY OF ANY KIND, EITHER EXPRESSED OR IMPLIED, INCLUDING, BUT NOT LIMITED TO, THE IMPLIED WARRANTIES OF MERCHANTABILITY AND FITNESS FOR A PARTICULAR PURPOSE. THE ENTIRE RISK AS TO THE QUALITY AND PERFORMANCE OF THE PROGRAM IS WITH YOU. SHOULD THE PROGRAM PROVE DEFECTIVE, YOU ASSUME THE COST OF ALL NECESSARY SERVICING, REPAIR OR CORRECTION.
12. IN NO EVENT UNLESS REQUIRED BY APPLICABLE LAW OR AGREED TO IN WRITING WILL ANY COPYRIGHT HOLDER, OR ANY OTHER PARTY WHO MAY MODIFY AND/OR REDISTRIBUTE THE PROGRAM AS PERMITTED ABOVE, BE LIABLE TO YOU FOR DAMAGES, INCLUDING ANY GENERAL, SPECIAL, INCIDENTAL OR CONSEQUENTIAL DAMAGES ARISING OUT OF THE USE OR INABILITY TO USE THE PROGRAM (INCLUDING BUT NOT LIMITED TO LOSS OF DATA OR DATA BEING RENDERED INACCURATE OR LOSSES SUSTAINED BY YOU OR THIRD PARTIES OR A FAILURE OF THE PROGRAM TO OPERATE WITH ANY OTHER PROGRAMS), EVEN IF SUCH HOLDER OR OTHER PARTY HAS BEEN ADVISED OF THE POSSIBILITY OF SUCH DAMAGES.

#### END OF TERMS AND CONDITIONS

##### Appendix: How to Apply These Terms to Your New Programs

If you develop a new program, and you want it to be of the greatest possible use to the public, the best way to achieve this is to make it free software which everyone can redistribute and change under these terms.

To do so, attach the following notices to the program. It is safest to attach them to the start of each source file to most effectively convey the exclusion of warranty; and each file should have at least the "copyright" line and a pointer to where the full notice is found.

<one line to give the program's name and a brief idea of what it does.>

Copyright (C) 19yy <name of author>

This program is free software; you can redistribute it and/or modify it under the terms of the GNU General Public License as published by the Free Software Foundation; either version 2 of the License, or (at your option) any later version.

This program is distributed in the hope that it will be useful, but WITHOUT ANY WARRANTY; without even the implied warranty of MERCHANTABILITY or FITNESS FOR A PARTICULAR PURPOSE. See the GNU General Public License for more details.

You should have received a copy of the GNU General Public License along with this program; if not, write to the Free Software Foundation, Inc., 675 Mass Ave, Cambridge, MA 02139, USA.

Also add information on how to contact you by electronic and paper mail.

If the program is interactive, make it output a short notice like this when it starts in an interactive mode:

```
Gnomovision version 69, Copyright (C) 19yy name of author
```

```
Gnomovision comes with ABSOLUTELY NO WARRANTY; for details type `show w'.
```

```
This is free software, and you are welcome to redistribute it under certain conditions; type `show c' for details.
```

The hypothetical commands `show w' and `show c' should show the appropriate parts of the General Public License. Of course, the commands you use may be called something other than `show w' and `show c'; they could even be mouse-clicks or menu items--whatever suits your program.

You should also get your employer (if you work as a programmer) or your school, if any, to sign a "copyright disclaimer" for the program, if necessary. Here is a sample; alter the names:

Yoyodyne, Inc., hereby disclaims all copyright interest in the program 'Gnomovision' (which makes passes at compilers) written by James Hacker.

<signature of Ty Coon>, 1 April 1989  
Ty Coon, President of Vice

This General Public License does not permit incorporating your program into proprietary programs. If your program is a subroutine library, you may consider it more useful to permit linking proprietary applications with the library. If this is what you want to do, use the GNU Library General Public License instead of this License.

### **3. Busybox, the Linux IR control package and SquashFS**

Busybox, the Linux IR control package and SquashFS are subject to the GPL, a copy of which is included at item 2.

### **4. DirectFB, glibc, libusb-compat, libusb and mtd-utils**

DirectFB, glibc, libmtp and libusb are subject to the following license:

GNU LESSER GENERAL PUBLIC LICENSE  
Version 2.1, February 1999

Copyright (C) 1991, 1999 Free Software Foundation, Inc.  
59 Temple Place, Suite 330, Boston, MA 02111-1307 USA

Everyone is permitted to copy and distribute verbatim copies of this license document, but changing it is not allowed.

[This is the first released version of the Lesser GPL. It also counts as the successor of the GNU Library Public License, version 2, hence the version number 2.1.]

#### **Preamble**

The licenses for most software are designed to take away your freedom to share and change it. By contrast, the GNU General Public Licenses are intended to guarantee your freedom to share and change free software--to make sure the software is free for all its users.

This license, the Lesser General Public License, applies to some specially designated software packages--typically libraries--of the Free Software Foundation and other authors who decide to use it. You can use it too, but we suggest you first think carefully about whether this license or the ordinary General Public License is the better strategy to use in any particular case, based on the explanations below.

When we speak of free software, we are referring to freedom of use, not price. Our General Public Licenses are designed to make sure that you have the freedom to distribute copies of free software (and charge for this service if you wish); that you receive source code or can get it if you want it; that you can change the software and use pieces of it in new free programs; and that you are informed that you can do these things.

To protect your rights, we need to make restrictions that forbid distributors to deny you these rights or to ask you to surrender these rights. These restrictions translate to certain responsibilities for you if you distribute copies of the library or if you modify it.

For example, if you distribute copies of the library, whether gratis or for a fee, you must give the recipients all the rights that we gave you. You must make sure that they, too, receive or can get the source code. If you link other code with the library, you must provide complete object files to the recipients, so that they can relink them with the library after making changes to the library and recompiling it. And you must show them these terms so they know their rights.

We protect your rights with a two-step method: (1) we copyright the library, and (2) we offer you this license, which gives you legal permission to copy, distribute and/or modify the library.

To protect each distributor, we want to make it very clear that there is no warranty for the free library. Also, if the library is modified by someone else and passed on, the recipients should know that what they have is not the original version, so that the original author's reputation will not be affected by problems that might be introduced by others.

Finally, software patents pose a constant threat to the existence of any free program. We wish to make sure that a company cannot effectively restrict the users of a free program by obtaining a restrictive license from a patent holder. Therefore, we insist that any patent license obtained for a version of the library must be consistent with the full freedom of use specified in this license.

Most GNU software, including some libraries, is covered by the ordinary GNU General Public License. This license, the GNU Lesser General Public License, applies to certain designated libraries, and is quite different from the ordinary General Public License. We use this license for certain libraries in order to permit linking those libraries into non-free programs.

When a program is linked with a library, whether statically or using a shared library, the combination of the two is legally speaking a combined work, a derivative of the original library. The ordinary General Public License therefore

permits such linking only if the entire combination fits its criteria of freedom. The Lesser General Public License permits more lax criteria for linking other code with the library.

We call this license the "Lesser" General Public License because it does Less to protect the user's freedom than the ordinary General Public License. It also provides other free software developers Less of an advantage over competing non-free programs. These disadvantages are the reason we use the ordinary General Public License for many libraries. However, the Lesser license provides advantages in certain special circumstances.

For example, on rare occasions, there may be a special need to encourage the widest possible use of a certain library, so that it becomes a de-facto standard. To achieve this, non-free programs must be allowed to use the library. A more frequent case is that a free library does the same job as widely used non-free libraries. In this case, there is little to gain by limiting the free library to free software only, so we use the Lesser General Public License.

In other cases, permission to use a particular library in non-free programs enables a greater number of people to use a large body of free software. For example, permission to use the GNU C Library in non-free programs enables many more people to use the whole GNU operating system, as well as its variant, the GNU/Linux operating system.

Although the Lesser General Public License is Less protective of the users' freedom, it does ensure that the user of a program that is linked with the Library has the freedom and the wherewithal to run that program using a modified version of the Library.

The precise terms and conditions for copying, distribution and modification follow. Pay close attention to the difference between a "work based on the library" and a "work that uses the library"; The former contains code derived from the library, whereas the latter must be combined with the library in order to run.

## GNU LESSER GENERAL PUBLIC LICENSE

### TERMS AND CONDITIONS FOR COPYING, DISTRIBUTION AND MODIFICATION

0. This License Agreement applies to any software library or other program which contains a notice placed by the copyright holder or other authorized party saying it may be distributed under the terms of this Lesser General Public License (also called "this License").

Each licensee is addressed as "you".

A "library" means a collection of software functions and/or data prepared so as to be conveniently linked with application programs (which use some of those functions and data) to form executables.

The "Library", below, refers to any such software library or work which has been distributed under these terms. A "work based on the Library" means either the Library or any derivative work under copyright law: that is to say, a work containing the Library or a portion of it, either verbatim or with modifications and/or translated straightforwardly into another language. (Hereinafter, translation is included without limitation in the term "modification".)

"Source code" for a work means the preferred form of the work for making modifications to it. For a library, complete source code means all the source code for all modules it contains, plus any associated interface definition files, plus the scripts used to control compilation and installation of the library.

Activities other than copying, distribution and modification are not covered by this License; they are outside its scope. The act of running a program using the Library is not restricted, and output from such a program is covered only if its contents constitute a work based on the Library (independent of the use of the Library in a tool for writing it). Whether that is true depends on what the Library does and what the program that uses the Library does.

1. You may copy and distribute verbatim copies of the Library's complete source code as you receive it, in any medium, provided that you conspicuously and appropriately publish on each copy an appropriate copyright notice and disclaimer of warranty; keep intact all the notices that refer to this License and to the absence of any warranty; and distribute a copy of this License along with the Library.

You may charge a fee for the physical act of transferring a copy, and you may at your option offer warranty protection in exchange for a fee.

2. You may modify your copy or copies of the Library or any portion of it, thus forming a work based on the Library, and copy and distribute such modifications or work under the terms of Section 1 above, provided that you also meet all of these conditions:
  - a) The modified work must itself be a software library.
  - b) You must cause the files modified to carry prominent notices stating that you changed the files and the date of any change.
  - c) You must cause the whole of the work to be licensed at no charge to all third parties under the terms of this License.

- d) If a facility in the modified Library refers to a function or a table of data to be supplied by an application program that uses the facility, other than as an argument passed when the facility is invoked, then you must make a good faith effort to ensure that, in the event an application does not supply such function or table, the facility still operates, and performs whatever part of its purpose remains meaningful.  
(For example, a function in a library to compute square roots has a purpose that is entirely well-defined independent of the application. Therefore, Subsection 2d requires that any application-supplied function or table used by this function must be optional: if the application does not supply it, the square root function must still compute square roots.)

These requirements apply to the modified work as a whole. If identifiable sections of that work are not derived from the Library, and can be reasonably considered independent and separate works in themselves, then this License, and its terms, do not apply to those sections when you distribute them as separate works. But when you distribute the same sections as part of a whole which is a work based on the Library, the distribution of the whole must be on the terms of this License, whose permissions for other licensees extend to the entire whole, and thus to each and every part regardless of who wrote it.

Thus, it is not the intent of this section to claim rights or contest your rights to work written entirely by you; rather, the intent is to exercise the right to control the distribution of derivative or collective works based on the Library.

In addition, mere aggregation of another work not based on the Library with the Library (or with a work based on the Library) on a volume of a storage or distribution medium does not bring the other work under the scope of this License.

3. You may opt to apply the terms of the ordinary GNU General Public License instead of this License to a given copy of the Library. To do this, you must alter all the notices that refer to this License, so that they refer to the ordinary GNU General Public License, version 2, instead of to this License. (If a newer version than version 2 of the ordinary GNU General Public License has appeared, then you can specify that version instead if you wish.) Do not make any other change in these notices.

Once this change is made in a given copy, it is irreversible for that copy, so the ordinary GNU General Public License applies to all subsequent copies and derivative works made from that copy.

This option is useful when you wish to copy part of the code of the Library into a program that is not a library.

4. You may copy and distribute the Library (or a portion or derivative of it, under Section 2) in object code or executable form under the terms of Sections 1 and 2 above provided that you accompany it with the complete corresponding machine-readable source code, which must be distributed under the terms of Sections 1 and 2 above on a medium customarily used for software interchange.

If distribution of object code is made by offering access to copy from a designated place, then offering equivalent access to copy the source code from the same place satisfies the requirement to distribute the source code, even though third parties are not compelled to copy the source along with the object code.

5. A program that contains no derivative of any portion of the Library, but is designed to work with the Library by being compiled or linked with it, is called a "work that uses the Library". Such a work, in isolation, is not a derivative work of the Library, and therefore falls outside the scope of this License.

However, linking a "work that uses the Library" with the Library creates an executable that is a derivative of the Library (because it contains portions of the Library), rather than a "work that uses the library". The executable is therefore covered by this License.

Section 6 states terms for distribution of such executables.

When a "work that uses the Library" uses material from a header file that is part of the Library, the object code for the work may be a derivative work of the Library even though the source code is not.

Whether this is true is especially significant if the work can be linked without the Library, or if the work is itself a library. The threshold for this to be true is not precisely defined by law.

If such an object file uses only numerical parameters, data structure layouts and accessors, and small macros and small inline functions (ten lines or less in length), then the use of the object file is unrestricted, regardless of whether it is legally a derivative work. (Executables containing this object code plus portions of the Library will still fall under Section 6.)

Otherwise, if the work is a derivative of the Library, you may distribute the object code for the work under the terms of Section 6.

Any executables containing that work also fall under Section 6, whether or not they are linked directly with the Library itself.

6. As an exception to the Sections above, you may also combine or link a "work that uses the Library" with the Library to produce a work containing portions of the Library, and distribute that work under terms of your choice, provided that the terms permit modification of the work for the customer's own use and reverse engineering for debugging such modifications.



You must give prominent notice with each copy of the work that the Library is used in it and that the Library and its use are covered by this License. You must supply a copy of this License. If the work during execution displays copyright notices, you must include the copyright notice for the Library among them, as well as a reference directing the user to the copy of this License. Also, you must do one of these things:

- a) Accompany the work with the complete corresponding machine-readable source code for the Library including whatever changes were used in the work (which must be distributed under Sections 1 and 2 above); and, if the work is an executable linked with the Library, with the complete machine-readable "work that uses the Library", as object code and/or source code, so that the user can modify the Library and then relink to produce a modified executable containing the modified Library. (It is understood that the user who changes the contents of definitions files in the Library will not necessarily be able to recompile the application to use the modified definitions.)
- b) Use a suitable shared library mechanism for linking with the Library. A suitable mechanism is one that (1) uses at run time a copy of the library already present on the user's computer system, rather than copying library functions into the executable, and (2) will operate properly with a modified version of the library, if the user installs one, as long as the modified version is interface-compatible with the version that the work was made with.
- c) Accompany the work with a written offer, valid for at least three years, to give the same user the materials specified in Subsection 6a, above, for a charge no more than the cost of performing this distribution.
- d) If distribution of the work is made by offering access to copy from a designated place, offer equivalent access to copy the above specified materials from the same place.
- e) Verify that the user has already received a copy of these materials or that you have already sent this user a copy.

For an executable, the required form of the "work that uses the library" must include any data and utility programs needed for reproducing the executable from it. However, as a special exception, the materials to be distributed need not include anything that is normally distributed (in either source or binary form) with the major components (compiler, kernel, and so on) of the operating system on which the executable runs, unless that component itself accompanies the executable.

It may happen that this requirement contradicts the license restrictions of other proprietary libraries that do not normally accompany the operating system. Such a contradiction means you cannot use both them and the Library together in an executable that you distribute.

7. You may place library facilities that are a work based on the Library side-by-side in a single library together with other library facilities not covered by this License, and distribute such a combined library, provided that the separate distribution of the work based on the Library and of the other library facilities is otherwise permitted, and provided that you do these two things:
  - a) Accompany the combined library with a copy of the same work based on the Library, uncombined with any other library facilities. This must be distributed under the terms of the Sections above.
  - b) Give prominent notice with the combined library of the fact that part of it is a work based on the Library, and explaining where to find the accompanying uncombined form of the same work.
8. You may not copy, modify, sublicense, link with, or distribute the Library except as expressly provided under this License. Any attempt otherwise to copy, modify, sublicense, link with, or distribute the Library is void, and will automatically terminate your rights under this License. However, parties who have received copies, or rights, from you under this License will not have their licenses terminated so long as such parties remain in full compliance.
9. You are not required to accept this License, since you have not signed it. However, nothing else grants you permission to modify or distribute the Library or its derivative works. These actions are prohibited by law if you do not accept this License. Therefore, by modifying or distributing the Library (or any work based on the Library), you indicate your acceptance of this License to do so, and all its terms and conditions for copying, distributing or modifying the Library or works based on it.
10. Each time you redistribute the Library (or any work based on the Library), the recipient automatically receives a license from the original licensor to copy, distribute, link with or modify the Library subject to these terms and conditions. You may not impose any further restrictions on the recipients' exercise of the rights granted herein. You are not responsible for enforcing compliance by third parties with this License.
11. If, as a consequence of a court judgment or allegation of patent infringement or for any other reason (not limited to patent issues), conditions are imposed on you (whether by court order, agreement or otherwise) that contradict the conditions of this License, they do not excuse you from the conditions of this License. If you cannot distribute so as to satisfy simultaneously your obligations under this License and any other pertinent obligations, then as a consequence you may not distribute the Library at all. For example, if a patent license would not permit royalty-

free redistribution of the Library by all those who receive copies directly or indirectly through you, then the only way you could satisfy both it and this License would be to refrain entirely from distribution of the Library.

If any portion of this section is held invalid or unenforceable under any particular circumstance, the balance of the section is intended to apply, and the section as a whole is intended to apply in other circumstances.

It is not the purpose of this section to induce you to infringe any patents or other property right claims or to contest validity of any such claims; this section has the sole purpose of protecting the integrity of the free software distribution system which is implemented by public license practices. Many people have made generous contributions to the wide range of software distributed through that system in reliance on consistent application of that system; it is up to the author/donor to decide if he or she is willing to distribute software through any other system and a licensee cannot impose that choice.

This section is intended to make thoroughly clear what is believed to be a consequence of the rest of this License.

12. If the distribution and/or use of the Library is restricted in certain countries either by patents or by copyrighted interfaces, the original copyright holder who places the Library under this License may add an explicit geographical distribution limitation excluding those countries, so that distribution is permitted only in or among countries not thus excluded. In such case, this License incorporates the limitation as if written in the body of this License.
13. The Free Software Foundation may publish revised and/or new versions of the Lesser General Public License from time to time. Such new versions will be similar in spirit to the present version, but may differ in detail to address new problems or concerns.

Each version is given a distinguishing version number. If the Library specifies a version number of this License which applies to it and "any later version", you have the option of following the terms and conditions either of that version or of any later version published by the Free Software Foundation. If the Library does not specify a license version number, you may choose any version ever published by the Free Software Foundation.

14. If you wish to incorporate parts of the Library into other free programs whose distribution conditions are incompatible with these, write to the author to ask for permission. For software which is copyrighted by the Free Software Foundation, write to the Free Software Foundation; we sometimes make exceptions for this. Our decision will be guided by the two goals of preserving the free status of all derivatives of our free software and of promoting the sharing and reuse of software generally.

#### NO WARRANTY

15. BECAUSE THE LIBRARY IS LICENSED FREE OF CHARGE, THERE IS NO WARRANTY FOR THE LIBRARY, TO THE EXTENT PERMITTED BY APPLICABLE LAW. EXCEPT WHEN OTHERWISE STATED IN WRITING THE COPYRIGHT HOLDERS AND/OR OTHER PARTIES PROVIDE THE LIBRARY "AS IS" WITHOUT WARRANTY OF ANY KIND, EITHER EXPRESSED OR IMPLIED, INCLUDING, BUT NOT LIMITED TO, THE IMPLIED WARRANTIES OF MERCHANTABILITY AND FITNESS FOR A PARTICULAR PURPOSE. THE ENTIRE RISK AS TO THE QUALITY AND PERFORMANCE OF THE LIBRARY IS WITH YOU. SHOULD THE LIBRARY PROVE DEFECTIVE, YOU ASSUME THE COST OF ALL NECESSARY SERVICING, REPAIR OR CORRECTION.
16. IN NO EVENT UNLESS REQUIRED BY APPLICABLE LAW OR AGREED TO IN WRITING WILL ANY COPYRIGHT HOLDER, OR ANY OTHER PARTY WHO MAY MODIFY AND/OR REDISTRIBUTE THE LIBRARY AS PERMITTED ABOVE, BE LIABLE TO YOU FOR DAMAGES, INCLUDING ANY GENERAL, SPECIAL, INCIDENTAL OR CONSEQUENTIAL DAMAGES ARISING OUT OF THE USE OR INABILITY TO USE THE LIBRARY (INCLUDING BUT NOT LIMITED TO LOSS OF DATA OR DATA BEING RENDERED INACCURATE OR LOSSES SUSTAINED BY YOU OR THIRD PARTIES OR A FAILURE OF THE LIBRARY TO OPERATE WITH ANY OTHER SOFTWARE), EVEN IF SUCH HOLDER OR OTHER PARTY HAS BEEN ADVISED OF THE POSSIBILITY OF SUCH DAMAGES.

#### END OF TERMS AND CONDITIONS

##### How to Apply These Terms to Your New Libraries

If you develop a new library, and you want it to be of the greatest possible use to the public, we recommend making it free software that everyone can redistribute and change. You can do so by permitting redistribution under these terms (or, alternatively, under the terms of the ordinary General Public License).

To apply these terms, attach the following notices to the library. It is safest to attach them to the start of each source file to most effectively convey the exclusion of warranty; and each file should have at least the "copyright" line and a pointer to where the full notice is found.

<one line to give the library's name and a brief idea of what it does.>

Copyright (C) <year> <name of author>

This library is free software; you can redistribute it and/or modify it under the terms of the GNU Lesser General Public License as published by the Free Software Foundation; either version 2.1 of the License, or (at your option) any later version.

This library is distributed in the hope that it will be useful, but WITHOUT ANY WARRANTY; without even the implied warranty of MERCHANTABILITY or FITNESS FOR A PARTICULAR PURPOSE. See the GNU Lesser General Public License for more details.

You should have received a copy of the GNU Lesser General Public License along with this library; if not, write to the Free Software Foundation, Inc., 59 Temple Place, Suite 330, Boston, MA 02111-1307 USA

Also add information on how to contact you by electronic and paper mail.

You should also get your employer (if you work as a programmer) or your school, if any, to sign a "copyright disclaimer" for the library, if necessary. Here is a sample; alter the names:

Yoyodyne, Inc., hereby disclaims all copyright interest in the library `Frob' (a library for tweaking knobs) written by James Random Hacker.

<signature of Ty Coon>, 1 April 1990

Ty Coon, President of Vice

That's all there is to it!

## 5. IJG: JPEG software decoder

The authors make NO WARRANTY or representation, either express or implied, with respect to this software, its quality, accuracy, merchantability, or fitness for a particular purpose. This software is provided "AS IS", and you, its user, assume the entire risk as to its quality and accuracy.

This software is copyright (C) 1991-1998, Thomas G. Lane.

All Rights Reserved except as specified below.

Permission is hereby granted to use, copy, modify, and distribute this software (or portions thereof) for any purpose, without fee, subject to these conditions:

- (1) If any part of the source code for this software is distributed, then this README file must be included, with this copyright and no-warranty notice unaltered; and any additions, deletions, or changes to the original files must be clearly indicated in accompanying documentation.
- (2) If only executable code is distributed, then the accompanying documentation must state that "this software is based in part on the work of the Independent JPEG Group".
- (3) Permission for use of this software is granted only if the user accepts full responsibility for any undesirable consequences; the authors accept NO LIABILITY for damages of any kind.

## 6. WPA Supplicant

Copyright (c) 2003-2009, Jouni Malinen <j@w1.fi> and contributors

All Rights Reserved.

Redistribution and use in source and binary forms, with or without modification, are permitted provided that the following conditions are met:

1. Redistributions of source code must retain the above copyright notice, this list of conditions and the following disclaimer.
2. Redistributions in binary form must reproduce the above copyright notice, this list of conditions and the following disclaimer in the documentation and/or other materials provided with the distribution.
3. Neither the name(s) of the above-listed copyright holder(s) nor the names of its contributors may be used to endorse or promote products derived from this software without specific prior written permission.

THIS SOFTWARE IS PROVIDED BY THE COPYRIGHT HOLDERS AND CONTRIBUTORS "AS IS" AND ANY EXPRESS OR IMPLIED WARRANTIES, INCLUDING, BUT NOT LIMITED TO, THE IMPLIED WARRANTIES OF MERCHANTABILITY AND FITNESS FOR A PARTICULAR PURPOSE ARE DISCLAIMED. IN NO EVENT SHALL THE COPYRIGHT OWNER OR CONTRIBUTORS BE LIABLE FOR ANY DIRECT, INDIRECT, INCIDENTAL, SPECIAL, EXEMPLARY, OR CONSEQUENTIAL DAMAGES (INCLUDING, BUT NOT LIMITED TO, PROCUREMENT OF SUBSTITUTE GOODS OR SERVICES; LOSS OF USE, DATA, OR PROFITS; OR BUSINESS INTERRUPTION) HOWEVER CAUSED AND ON ANY THEORY OF LIABILITY, WHETHER IN CONTRACT, STRICT LIABILITY, OR TORT (INCLUDING NEGLIGENCE OR OTHERWISE) ARISING IN ANY WAY OUT OF THE USE OF THIS SOFTWARE, EVEN IF ADVISED OF THE POSSIBILITY OF SUCH DAMAGE.

## 7. Unicode Bidirectional Algorithm

For the general privacy policy governing access to this site, see the Unicode Privacy Policy. For trademark usage, see the Unicode Consortium® Trademarks and Logo Policy.

Notice to End User: Terms of Use

Carefully read the following legal agreement ("Agreement"). Use or copying of the software and/or codes provided with this agreement (The "Software") constitutes your acceptance of these terms

Unicode Copyright.

Copyright © 1991-2009 Unicode, Inc. All rights reserved.

Certain documents and files on this website contain a legend indicating that "Modification is permitted." Any person is hereby authorized, without fee, to modify such documents and files to create derivative works conforming to the Unicode® Standard, subject to Terms and Conditions herein.

Any person is hereby authorized, without fee, to view, use, reproduce, and distribute all documents and files solely for informational purposes in the creation of products supporting the Unicode Standard, subject to the Terms and Conditions herein.

Further specifications of rights and restrictions pertaining to the use of the particular set of data files known as the "Unicode Character Database" can be found in Exhibit 1.

Each version of the Unicode Standard has further specifications of rights and restrictions of use. For the book editions, these are found on the back of the title page. For the online edition, certain files (such as the PDF files for book chapters and code charts) carry specific restrictions. All other files are covered under these general Terms of Use. To request a permission to reproduce any part of the Unicode Standard, please contact the Unicode Consortium.

No license is granted to "mirror" the Unicode website where a fee is charged for access to the "mirror" site.

Modification is not permitted with respect to this document. All copies of this document must be verbatim.

Restricted Rights Legend. Any technical data or software which is licensed to the United States of America, its agencies and/or instrumentalities under this Agreement is commercial technical data or commercial computer software developed exclusively at private expense as defined in FAR 2.101, or DFARS 252.227-7014 (June 1995), as applicable. For technical data, use, duplication, or disclosure by the Government is subject to restrictions as set forth in DFARS 202.227-7015 Technical Data, Commercial and Items (Nov 1995) and this Agreement. For Software, in accordance with FAR 12-212 or DFARS 227-7202, as applicable, use, duplication or disclosure by the Government is subject to the restrictions set forth in this Agreement.

Warranties and Disclaimers.

This publication and/or website may include technical or typographical errors or other inaccuracies. Changes are periodically added to the information herein; these changes will be incorporated in new editions of the publication and/or website. Unicode may make improvements and/or changes in the product(s) and/or program(s) described in this publication and/or website at any time.

If this file has been purchased on magnetic or optical media from Unicode, Inc. the sole and exclusive remedy for any claim will be exchange of the defective media within ninety (90) days of original purchase.

EXCEPT AS PROVIDED IN SECTION C.2, THIS PUBLICATION AND/OR SOFTWARE IS PROVIDED "AS IS" WITHOUT WARRANTY OF ANY KIND EITHER EXPRESS, IMPLIED, OR STATUTORY, INCLUDING, BUT NOT LIMITED TO, ANY WARRANTIES OF MERCHANTABILITY, FITNESS FOR A PARTICULAR PURPOSE, OR NON-INFRINGEMENT. UNICODE AND ITS LICENSORS ASSUME NO RESPONSIBILITY FOR ERRORS OR OMISSIONS IN THIS PUBLICATION AND/OR SOFTWARE OR OTHER DOCUMENTS WHICH ARE REFERENCED BY OR LINKED TO THIS PUBLICATION OR THE UNICODE WEBSITE.

Waiver of Damages. In no event shall Unicode or its licensors be liable for any special, incidental, indirect or consequential damages of any kind, or any damages whatsoever, whether or not Unicode was advised of the possibility of the damage, including, without limitation, those resulting from the following: loss of use, data or profits, in connection with the use, modification or distribution of this information or its derivatives.

Trademarks.

Unicode and the Unicode logo are registered trademarks of Unicode, Inc.

This site contains product names and corporate names of other companies. All product names and company names and logos mentioned herein are the trademarks or registered trademarks of their respective owners. Other products and corporate names mentioned herein which are trademarks of a third party are used only for explanation and for the owners' benefit and with no intent to infringe.

Use of third party products or information referred to herein is at the user's risk.

Miscellaneous.

Jurisdiction and Venue. This server is operated from a location in the State of California, United States of America. Unicode makes no representation that the materials are appropriate for use in other locations. If you access this server from other locations, you are responsible for compliance with local laws. This Agreement, all use of this site and any

claims and damages resulting from use of this site are governed solely by the laws of the State of California without regard to any principles which would apply the laws of a different jurisdiction. The user agrees that any disputes regarding this site shall be resolved solely in the courts located in Santa Clara County, California. The user agrees said courts have personal jurisdiction and agree to waive any right to transfer the dispute to any other forum.

Modification by Unicode Unicode shall have the right to modify this Agreement at any time by posting it to this site. The user may not assign any part of this Agreement without Unicode's prior written consent.

Taxes. The user agrees to pay any taxes arising from access to this website or use of the information herein, except for those based on Unicode's net income.

Severability. If any provision of this Agreement is declared invalid or unenforceable, the remaining provisions of this Agreement shall remain in effect.

Entire Agreement. This Agreement constitutes the entire agreement between the parties.

---

#### EXHIBIT 1

#### UNICODE, INC. LICENSE AGREEMENT - DATA FILES AND SOFTWARE

Unicode Data Files include all data files under the directories <http://www.unicode.org/Public/>, <http://www.unicode.org/reports/>, and <http://www.unicode.org/cldr/data/>. Unicode Software includes any source code published in the Unicode Standard or under the directories <http://www.unicode.org/Public/>, <http://www.unicode.org/reports/>, and <http://www.unicode.org/cldr/data/>.

NOTICE TO USER: Carefully read the following legal agreement. BY DOWNLOADING, INSTALLING, COPYING OR OTHERWISE USING UNICODE INC.'S DATA FILES ("DATA FILES"), AND/OR SOFTWARE ("SOFTWARE"), YOU UNEQUIVOCALLY ACCEPT, AND AGREE TO BE BOUND BY, ALL OF THE TERMS AND CONDITIONS OF THIS AGREEMENT. IF YOU DO NOT AGREE, DO NOT DOWNLOAD, INSTALL, COPY, DISTRIBUTE OR USE THE DATA FILES OR SOFTWARE.

#### COPYRIGHT AND PERMISSION NOTICE

Copyright © 1991-2009 Unicode, Inc. All rights reserved. Distributed under the Terms of Use in <http://www.unicode.org/copyright.html>.

Permission is hereby granted, free of charge, to any person obtaining a copy of the Unicode data files and any associated documentation (the "Data Files") or Unicode software and any associated documentation (the "Software") to deal in the Data Files or Software without restriction, including without limitation the rights to use, copy, modify, merge, publish, distribute, and/or sell copies of the Data Files or Software, and to permit persons to whom the Data Files or Software are furnished to do so, provided that (a) the above copyright notice(s) and this permission notice appear with all copies of the Data Files or Software, (b) both the above copyright notice(s) and this permission notice appear in associated documentation, and (c) there is clear notice in each modified Data File or in the Software as well as in the documentation associated with the Data File(s) or Software that the data or software has been modified.

THE DATA FILES AND SOFTWARE ARE PROVIDED "AS IS", WITHOUT WARRANTY OF ANY KIND, EXPRESS OR IMPLIED, INCLUDING BUT NOT LIMITED TO THE WARRANTIES OF MERCHANTABILITY, FITNESS FOR A PARTICULAR PURPOSE AND NONINFRINGEMENT OF THIRD PARTY RIGHTS. IN NO EVENT SHALL THE COPYRIGHT HOLDER OR HOLDERS INCLUDED IN THIS NOTICE BE LIABLE FOR ANY CLAIM, OR ANY SPECIAL INDIRECT OR CONSEQUENTIAL DAMAGES, OR ANY DAMAGES WHATSOEVER RESULTING FROM LOSS OF USE, DATA OR PROFITS, WHETHER IN AN ACTION OF CONTRACT, NEGLIGENCE OR OTHER TORTIOUS ACTION, ARISING OUT OF OR IN CONNECTION WITH THE USE OR PERFORMANCE OF THE DATA FILES OR SOFTWARE.

Except as contained in this notice, the name of a copyright holder shall not be used in advertising or otherwise to promote the sale, use or other dealings in these Data Files or Software without prior written authorization of the copyright holder.

---

Unicode and the Unicode logo are trademarks of Unicode, Inc., and may be registered in some jurisdictions. All other trademarks and registered trademarks mentioned herein are the property of their respective owners.

---

## **8. OpenSSL.**

Open SSL is an Open Source toolkit implementing the Secure Sockets Layer (SSL v2/v3) and Transport Layer Security (TLS v1) protocols as well as a full-strength general purpose cryptography library.

See <http://www.openssl.org/>, and in particular <http://www.openssl.org/source/license.html>.

The license conditions are copied below.

The OpenSSL toolkit stays under a dual license, i.e. both the conditions of the OpenSSL License and the original SSLeay license apply to the toolkit.

See below for the actual license texts. Actually both licenses are BSD-style Open Source licenses. In case of any license issues related to OpenSSL, please contact [openssl-core@openssl.org](mailto:openssl-core@openssl.org).

#### OpenSSL License

```
-----  
/* =====  
* Copyright (c) 1998-2008 The OpenSSL Project. All rights reserved.  
*  
* Redistribution and use in source and binary forms, with or without  
* modification, are permitted provided that the following conditions  
* are met:  
*  
* 1. Redistributions of source code must retain the above copyright  
* notice, this list of conditions and the following disclaimer.  
*  
* 2. Redistributions in binary form must reproduce the above copyright  
* notice, this list of conditions and the following disclaimer in  
* the documentation and/or other materials provided with the  
* distribution.  
*  
* 3. All advertising materials mentioning features or use of this  
* software must display the following acknowledgment:  
* "This product includes software developed by the OpenSSL Project  
* for use in the OpenSSL Toolkit. (http://www.openssl.org/)"  
*  
* 4. The names "OpenSSL Toolkit" and "OpenSSL Project" must not be used to  
* endorse or promote products derived from this software without  
* prior written permission. For written permission, please contact  
* openssl-core@openssl.org.  
*  
* 5. Products derived from this software may not be called "OpenSSL"  
* nor may "OpenSSL" appear in their names without prior written  
* permission of the OpenSSL Project.  
*  
* 6. Redistributions of any form whatsoever must retain the following  
* acknowledgment:  
* "This product includes software developed by the OpenSSL Project  
* for use in the OpenSSL Toolkit (http://www.openssl.org/)"  
*  
* THIS SOFTWARE IS PROVIDED BY THE OpenSSL PROJECT "AS IS" AND ANY  
* EXPRESSED OR IMPLIED WARRANTIES, INCLUDING, BUT NOT LIMITED TO, THE  
* IMPLIED WARRANTIES OF MERCHANTABILITY AND FITNESS FOR A PARTICULAR  
* PURPOSE ARE DISCLAIMED. IN NO EVENT SHALL THE OpenSSL PROJECT OR  
* ITS CONTRIBUTORS BE LIABLE FOR ANY DIRECT, INDIRECT, INCIDENTAL,  
* SPECIAL, EXEMPLARY, OR CONSEQUENTIAL DAMAGES (INCLUDING, BUT  
* NOT LIMITED TO, PROCUREMENT OF SUBSTITUTE GOODS OR SERVICES;  
* LOSS OF USE, DATA, OR PROFITS; OR BUSINESS INTERRUPTION)  
* HOWEVER CAUSED AND ON ANY THEORY OF LIABILITY, WHETHER IN  
* CONTRACT, STRICT LIABILITY, OR TORT (INCLUDING NEGLIGENCE OR  
* OTHERWISE) ARISING IN ANY WAY OUT OF THE USE OF THIS SOFTWARE,  
* EVEN IF ADVISED OF THE POSSIBILITY OF SUCH DAMAGE.  
* =====  
*  
* This product includes cryptographic software written by Eric Young  
* (eay@cryptsoft.com). This product includes software written by Tim  
* Hudson (tjh@cryptsoft.com).  
*  
*/
```

#### Original SSLeay License

-----

```

/* Copyright (C) 1995-1998 Eric Young (eay@cryptsoft.com)
* All rights reserved.
*
* This package is an SSL implementation written
* by Eric Young (eay@cryptsoft.com).
* The implementation was written so as to conform with Netscapes SSL.
*
* This library is free for commercial and non-commercial use as long as
* the following conditions are aheared to. The following conditions
* apply to all code found in this distribution, be it the RC4, RSA,
* lhash, DES, etc., code; not just the SSL code. The SSL documentation
* included with this distribution is covered by the same copyright terms
* except that the holder is Tim Hudson (tjh@cryptsoft.com).
*
* Copyright remains Eric Young's, and as such any Copyright notices in
* the code are not to be removed.
* If this package is used in a product, Eric Young should be given attribution
* as the author of the parts of the library used.
* This can be in the form of a textual message at program startup or
* in documentation (online or textual) provided with the package.
*
* Redistribution and use in source and binary forms, with or without
* modification, are permitted provided that the following conditions
* are met:
* 1. Redistributions of source code must retain the copyright
* notice, this list of conditions and the following disclaimer.
* 2. Redistributions in binary form must reproduce the above copyright
* notice, this list of conditions and the following disclaimer in the
* documentation and/or other materials provided with the distribution.
* 3. All advertising materials mentioning features or use of this software
* must display the following acknowledgement:
* "This product includes cryptographic software written by
* Eric Young (eay@cryptsoft.com)"
* The word 'cryptographic' can be left out if the rouines from the library
* being used are not cryptographic related :-).
* 4. If you include any Windows specific code (or a derivative thereof) from
* the apps directory (application code) you must include an acknowledgement:
* "This product includes software written by Tim Hudson (tjh@cryptsoft.com)"
*
* THIS SOFTWARE IS PROVIDED BY ERIC YOUNG ``AS IS'' AND ANY EXPRESS OR
* IMPLIED WARRANTIES, INCLUDING, BUT NOT LIMITED TO, THE IMPLIED
* WARRANTIES OF MERCHANTABILITY AND FITNESS FOR A PARTICULAR
* PURPOSE ARE DISCLAIMED. IN NO EVENT SHALL THE AUTHOR OR
* CONTRIBUTORS BE LIABLE FOR ANY DIRECT, INDIRECT, INCIDENTAL,
* SPECIAL, EXEMPLARY, OR CONSEQUENTIAL DAMAGES (INCLUDING, BUT
* NOT LIMITED TO, PROCUREMENT OF SUBSTITUTE GOODS OR SERVICES; LOSS
* OF USE, DATA, OR PROFITS; OR BUSINESS INTERRUPTION) HOWEVER
* CAUSED AND ON ANY THEORY OF LIABILITY, WHETHER IN CONTRACT,
* STRICT LIABILITY, OR TORT (INCLUDING NEGLIGENCE OR OTHERWISE)
* ARISING IN ANY WAY OUT OF THE USE OF THIS SOFTWARE, EVEN IF ADVISED
* OF THE POSSIBILITY OF SUCH DAMAGE.
*
* The licence and distribution terms for any publicly available version or
* derivative of this code cannot be changed. i.e. this code cannot simply be
* copied and put under another distribution licence
* [including the GNU Public Licence.]
*/

```

## 9. Zlib general purpose compression library

See <http://www.zlib.net/>, and in particular [http://www.zlib.net/zlib\\_license.html](http://www.zlib.net/zlib_license.html).

```
/* zlib.h -- interface of the 'zlib' general purpose compression library version 1.2.3, July 18th, 2005
```

```
Copyright (C) 1995-2005 Jean-loup Gailly and Mark Adler
```

```
This software is provided 'as-is', without any express or implied warranty. In no event will the authors be held liable for any damages arising from the use of this software.
```

```
Permission is granted to anyone to use this software for any purpose, including commercial applications, and to alter it and redistribute it freely, subject to the following restrictions:
```

1. The origin of this software must not be misrepresented; you must not claim that you wrote the original software. If you use this software in a product, an acknowledgment in the product documentation would be appreciated but is not required.
2. Altered source versions must be plainly marked as such, and must not be misrepresented as being the original software.
3. This notice may not be removed or altered from any source distribution.

```
Jean-loup Gailly jloup@gzip.org
```

```
Mark Adler madler@alumni.caltech.edu
```

```
*/
```

## 10. cURL

COPYRIGHT AND PERMISSION NOTICE

Copyright (c) 1996 - 2010, Daniel Stenberg, <daniel@haxx.se>.

All rights reserved.

Permission to use, copy, modify, and distribute this software for any purpose with or without fee is hereby granted, provided that the above copyright notice and this permission notice appear in all copies.

THE SOFTWARE IS PROVIDED "AS IS", WITHOUT WARRANTY OF ANY KIND, EXPRESS OR IMPLIED, INCLUDING BUT NOT LIMITED TO THE WARRANTIES OF MERCHANTABILITY, FITNESS FOR A PARTICULAR PURPOSE AND NONINFRINGEMENT OF THIRD PARTY RIGHTS. IN NO EVENT SHALL THE AUTHORS OR COPYRIGHT HOLDERS BE LIABLE FOR ANY CLAIM, DAMAGES OR OTHER LIABILITY, WHETHER IN AN ACTION OF CONTRACT, TORT OR OTHERWISE, ARISING FROM, OUT OF OR IN CONNECTION WITH THE SOFTWARE OR THE USE OR OTHER DEALINGS IN THE SOFTWARE.

Except as contained in this notice, the name of a copyright holder shall not be used in advertising or otherwise to promote the sale, use or other dealings in this Software without prior written authorization of the copyright holder.

## 11. Freetype, a Free, High-Quality, and Portable Font Engine

The software is based in part of the work of the FreeType Team.

See <http://freetype.sourceforge.net/>, and in particular <http://freetype.sourceforge.net/FTL.TXT>.

Portions of the relevant license conditions are copied below.

The FreeType Project LICENSE

2006-Jan-27

Copyright 1996-2002, 2006 by David Turner, Robert Wilhelm, and Werner Lemberg

...

1. No Warranty

-----

THE FREETYPE PROJECT IS PROVIDED 'AS IS' WITHOUT WARRANTY OF ANY KIND, EITHER EXPRESS OR IMPLIED, INCLUDING, BUT NOT LIMITED TO, WARRANTIES OF MERCHANTABILITY AND FITNESS FOR A PARTICULAR PURPOSE. IN NO EVENT WILL ANY OF THE AUTHORS OR COPYRIGHT HOLDERS BE LIABLE FOR ANY DAMAGES CAUSED BY THE USE OR THE INABILITY TO USE, OF THE FREETYPE PROJECT.

2. Redistribution

-----

This license grants a worldwide, royalty-free, perpetual and irrevocable right and license to use, execute, perform, compile, display, copy, create derivative works of, distribute and sublicense the FreeType Project (in both source and



object code forms) and derivative works thereof for any purpose; and to authorize others to exercise some or all of the rights granted herein, subject to the following conditions:

...

- o Redistribution in binary form must provide a disclaimer that states that the software is based in part of the work of the FreeType Team, in the distribution documentation. We also encourage you to put an URL to the FreeType web page in your documentation, though this isn't mandatory.

...

## **12. International Components for Unicode**

### **COPYRIGHT AND PERMISSION NOTICE**

Copyright (c) 1995-2009 International Business Machines Corporation and others

All rights reserved.

Permission is hereby granted, free of charge, to any person obtaining a copy of this software and associated documentation files (the "Software"), to deal in the Software without restriction, including without limitation the rights to use, copy, modify, merge, publish, distribute, and/or sell copies of the Software, and to permit persons to whom the Software is furnished to do so, provided that the above copyright notice(s) and this permission notice appear in all copies of the Software and that both the above copyright notice(s) and this permission notice appear in supporting documentation.

THE SOFTWARE IS PROVIDED "AS IS", WITHOUT WARRANTY OF ANY KIND, EXPRESS OR IMPLIED, INCLUDING BUT NOT LIMITED TO THE WARRANTIES OF MERCHANTABILITY, FITNESS FOR A PARTICULAR PURPOSE AND NONINFRINGEMENT OF THIRD PARTY RIGHTS. IN NO EVENT SHALL THE COPYRIGHT HOLDER OR HOLDERS INCLUDED IN THIS NOTICE BE LIABLE FOR ANY CLAIM, OR ANY SPECIAL INDIRECT OR CONSEQUENTIAL DAMAGES, OR ANY DAMAGES WHATSOEVER RESULTING FROM LOSS OF USE, DATA OR PROFITS, WHETHER IN AN ACTION OF CONTRACT, NEGLIGENCE OR OTHER TORTIOUS ACTION, ARISING OUT OF OR IN CONNECTION WITH THE USE OR PERFORMANCE OF THIS SOFTWARE.

Except as contained in this notice, the name of a copyright holder shall not be used in advertising or otherwise to promote the sale, use or other dealings in this Software without prior written authorization of the copyright holder.

## **13. Expat**

Copyright (c) 1998, 1999, 2000 Thai Open Source Software Center Ltd and Clark Cooper

Copyright (c) 2001, 2002, 2003, 2004, 2005, 2006 Expat maintainers.

Permission is hereby granted, free of charge, to any person obtaining a copy of this software and associated documentation files (the "Software"), to deal in the Software without restriction, including without limitation the rights to use, copy, modify, merge, publish, distribute, sublicense, and/or sell copies of the Software, and to permit persons to whom the Software is furnished to do so, subject to the following conditions:

The above copyright notice and this permission notice shall be included in all copies or substantial portions of the Software.

THE SOFTWARE IS PROVIDED "AS IS", WITHOUT WARRANTY OF ANY KIND, EXPRESS OR IMPLIED, INCLUDING BUT NOT LIMITED TO THE WARRANTIES OF MERCHANTABILITY, FITNESS FOR A PARTICULAR PURPOSE AND NONINFRINGEMENT.

IN NO EVENT SHALL THE AUTHORS OR COPYRIGHT HOLDERS BE LIABLE FOR ANY CLAIM, DAMAGES OR OTHER LIABILITY, WHETHER IN AN ACTION OF CONTRACT, TORT OR OTHERWISE, ARISING FROM, OUT OF OR IN CONNECTION WITH THE SOFTWARE OR THE USE OR OTHER DEALINGS IN THE SOFTWARE.

## **14. DNS Resolver**

The DNS resolver code, taken from BIND 4.9.5, is copyrighted both by UC Berkeley and by Digital Equipment Corporation. The DEC portions are under the following license:

Portions Copyright (C) 1993 by Digital Equipment Corporation.

Permission to use, copy, modify, and distribute this software for any purpose with or without fee is hereby granted, provided that the above copyright notice and this permission notice appear in all copies, and that the name of Digital Equipment Corporation not be used in advertising or publicity pertaining to distribution of the document or software without specific, written prior permission.

THE SOFTWARE IS PROVIDED "AS IS" AND DIGITAL EQUIPMENT CORP. DISCLAIMS ALL WARRANTIES WITH REGARD TO THIS SOFTWARE, INCLUDING ALL IMPLIED WARRANTIES OF MERCHANTABILITY AND

FITNESS. IN NO EVENT SHALL DIGITAL EQUIPMENT CORPORATION BE LIABLE FOR ANY SPECIAL, DIRECT, INDIRECT, OR CONSEQUENTIAL DAMAGES OR ANY DAMAGES WHATSOEVER RESULTING FROM LOSS OF USE, DATA OR PROFITS, WHETHER IN AN ACTION OF CONTRACT, NEGLIGENCE OR OTHER TORTIOUS ACTION, ARISING OUT OF OR IN CONNECTION WITH THE USE OR PERFORMANCE OF THIS SOFTWARE.

## 15. getnameinfo, getaddrinfo

The files `inet/getnameinfo.c` and `sysdeps/posix/getaddrinfo.c` are copyright (C) by Craig Metz and are distributed under the following license:

```
/* The Inner Net License, Version 2.00
```

The author(s) grant permission for redistribution and use in source and binary forms, with or without modification, of the software and documentation provided that the following conditions are met:

0. If you receive a version of the software that is specifically labelled as not being for redistribution (check the version message and/or README), you are not permitted to redistribute that version of the software in any way or form.
1. All terms of the all other applicable copyrights and licenses must be followed.
2. Redistributions of source code must retain the authors' copyright notice(s), this list of conditions, and the following disclaimer:
3. Redistributions in binary form must reproduce the authors' copyright notice(s), this list of conditions, and the following disclaimer in the documentation and/or other materials provided with the distribution.
4. [The copyright holder has authorized the removal of this clause.]
5. Neither the name(s) of the author(s) nor the names of its contributors may be used to endorse or promote products derived from this software without specific prior written permission.

THIS SOFTWARE IS PROVIDED BY ITS AUTHORS AND CONTRIBUTORS "AS IS" AND ANY EXPRESS OR IMPLIED WARRANTIES, INCLUDING, BUT NOT LIMITED TO, THE IMPLIED WARRANTIES OF MERCHANTABILITY AND FITNESS FOR A PARTICULAR PURPOSE ARE DISCLAIMED. IN NO EVENT SHALL THE AUTHORS OR CONTRIBUTORS BE LIABLE FOR ANY DIRECT, INDIRECT, INCIDENTAL, SPECIAL, EXEMPLARY, OR CONSEQUENTIAL DAMAGES (INCLUDING, BUT NOT LIMITED TO, PROCUREMENT OF SUBSTITUTE GOODS OR SERVICES; LOSS OF USE, DATA, OR PROFITS; OR BUSINESS INTERRUPTION) HOWEVER CAUSED AND ON ANY THEORY OF LIABILITY, WHETHER IN CONTRACT, STRICT LIABILITY, OR TORT (INCLUDING NEGLIGENCE OR OTHERWISE) ARISING IN ANY WAY OUT OF THE USE OF THIS SOFTWARE, EVEN IF ADVISED OF THE POSSIBILITY OF SUCH DAMAGE.

If these license terms cause you a real problem, contact the author. \*/

## 16. libpng

This copy of the libpng notices is provided for your convenience. In case of any discrepancy between this copy and the notices in the file `png.h` that is included in the libpng distribution, the latter shall prevail.

COPYRIGHT NOTICE, DISCLAIMER, and LICENSE:

If you modify libpng you may insert additional notices immediately following this sentence.

This code is released under the libpng license.

libpng versions 1.2.6, August 15, 2004, through 1.2.41, December 3, 2009, are Copyright (c) 2004, 2006-2009 Glenn Randers-Pehrson, and are distributed according to the same disclaimer and license as libpng-1.2.5 with the following individual added to the list of Contributing Authors

Cosmin Truta

libpng versions 1.0.7, July 1, 2000, through 1.2.5 - October 3, 2002, are

Copyright (c) 2000-2002 Glenn Randers-Pehrson, and are distributed according to the same disclaimer and license as libpng-1.0.6 with the following individuals added to the list of Contributing Authors

Simon-Pierre Cadieux

Eric S. Raymond

Gilles Vollant

and with the following additions to the disclaimer:

There is no warranty against interference with your enjoyment of the library or against infringement. There is no warranty that our efforts or the library will fulfill any of your particular purposes or needs. This library is provided with all faults, and the entire risk of satisfactory quality, performance, accuracy, and effort is with the user.

libpng versions 0.97, January 1998, through 1.0.6, March 20, 2000, are Copyright (c) 1998, 1999 Glenn Randers-Pehrson, and are distributed according to the same disclaimer and license as libpng-0.96, with the following individuals added to the list of Contributing Authors:

Tom Lane

Glenn Randers-Pehrson

Willem van Schaik

libpng versions 0.89, June 1996, through 0.96, May 1997, are Copyright (c) 1996, 1997 Andreas Dilger

Distributed according to the same disclaimer and license as libpng-0.88, with the following individuals added to the list of Contributing Authors:

John Bowler

Kevin Bracey

Sam Bushell

Magnus Holmgren

Greg Roelofs

Tom Tanner

libpng versions 0.5, May 1995, through 0.88, January 1996, are Copyright (c) 1995, 1996 Guy Eric Schalnat, Group 42, Inc.

For the purposes of this copyright and license, "Contributing Authors" is defined as the following set of individuals:

Andreas Dilger

Dave Martindale

Guy Eric Schalnat

Paul Schmidt

Tim Wegner

The PNG Reference Library is supplied "AS IS". The Contributing Authors and Group 42, Inc. disclaim all warranties, expressed or implied, including, without limitation, the warranties of merchantability and of fitness for any purpose. The Contributing Authors and Group 42, Inc. assume no liability for direct, indirect, incidental, special, exemplary, or consequential damages, which may result from the use of the PNG Reference Library, even if advised of the possibility of such damage.

Permission is hereby granted to use, copy, modify, and distribute this source code, or portions hereof, for any purpose, without fee, subject to the following restrictions:

1. The origin of this source code must not be misrepresented.
2. Altered versions must be plainly marked as such and must not be misrepresented as being the original source.
3. This Copyright notice may not be removed or altered from any source or altered source distribution.

The Contributing Authors and Group 42, Inc. specifically permit, without fee, and encourage the use of this source code as a component to supporting the PNG file format in commercial products. If you use this source code in a product, acknowledgment is not required but would be appreciated.

A "png\_get\_copyright" function is available, for convenient use in "about" boxes and the like:

```
printf("%s",png_get_copyright(NULL));
```

Also, the PNG logo (in PNG format, of course) is supplied in the files "pngbar.png" and "pngbar.jpg (88x31) and "pngnow.png" (98x31).

Libpng is OSI Certified Open Source Software. OSI Certified Open Source is a certification mark of the Open Source Initiative.

Glenn Randers-Pehrson

glennrp at users.sourceforge.net

December 3, 2009

## **17. SQLite**

All of the deliverable code in SQLite has been dedicated to the HYPERLINK "[http://en.wikipedia.org/wiki/Public\\_Domain](http://en.wikipedia.org/wiki/Public_Domain)" public domain by the authors. All code authors, and representatives of the companies they work for, have signed affidavits dedicating their contributions to the public domain and originals of those signed affidavits are stored

in a firesafe at the main offices of HYPERLINK "<http://www.hwaci.com>"Hwaci. Anyone is free to copy, modify, publish, use, compile, sell, or distribute the original SQLite code, either in source code form or as a compiled binary, for any purpose, commercial or non-commercial, and by any means.

The previous paragraph applies to the deliverable code in SQLite - those parts of the SQLite library that you actually bundle and ship with a larger application. Portions of the documentation and some code used as part of the build process might fall under other licenses. The details here are unclear. We do not worry about the licensing of the documentation and build code so much because none of these things are part of the core deliverable SQLite library.

All of the deliverable code in SQLite has been written from scratch. No code has been taken from other projects or from the open internet. Every line of code can be traced back to its original author, and all of those authors have public domain dedications on file. So the SQLite code base is clean and is uncontaminated with licensed code from other projects.

## **18. libxml2**

Except where otherwise noted in the source code (e.g. the files hash.c, list.c and the trio files, which are covered by a similar licence but with different Copyright notices) all the files are:

Copyright (C) 1998-2003 Daniel Veillard. All Rights Reserved.

Permission is hereby granted, free of charge, to any person obtaining a copy of this software and associated documentation files (the "Software"), to deal in the Software without restriction, including without limitation the rights to use, copy, modify, merge, publish, distribute, sublicense, and/or sell copies of the Software, and to permit persons to whom the Software is furnished to do so, subject to the following conditions:

The above copyright notice and this permission notice shall be included in all copies or substantial portions of the Software.

THE SOFTWARE IS PROVIDED "AS IS", WITHOUT WARRANTY OF ANY KIND, EXPRESS OR IMPLIED, INCLUDING BUT NOT LIMITED TO THE WARRANTIES OF MERCHANTABILITY, FITNESS FOR A PARTICULAR PURPOSE AND NONINFRINGEMENT. IN NO EVENT SHALL THE DANIEL VEILLARD BE LIABLE FOR ANY CLAIM, DAMAGES OR OTHER LIABILITY, WHETHER IN AN ACTION OF CONTRACT, TORT OR OTHERWISE, ARISING FROM, OUT OF OR IN CONNECTION WITH THE SOFTWARE OR THE USE OR OTHER DEALINGS IN THE SOFTWARE.

Except as contained in this notice, the name of Daniel Veillard shall not be used in advertising or otherwise to promote the sale, use or other dealings in this Software without prior written authorization from him.

## 通知

### 软件最终用户许可协议

本软件最终用户许可协议（以下简称“本协议”）系由贵方（个人或实体）与飞利浦消费电子有限责任公司（Philips Consumer Lifestyle B.V.），一家荷兰有限责任公司，其主营场所位于：High Tech Campus 37, 5656 AE Eindhoven, the Netherlands 及其子公司（单称和统称“飞利浦”）之间订立的一份具有法律约束力的协议。本协议授权贵方使用某些软件（以下称“软件”），包括用户电子文档。这些软件可单独提供，也可与飞利浦产品（以下称“设备”）或电脑一起提供。如果你下载、安装或以其他方式使用软件，则意味着你已经接受并同意受本协议所有条款和条件的约束。如果不同意这些条款和条件，请不要下载、安装或以其他方式使用软件。如果你通过 CD 等有形介质获得软件，没有机会审读本许可协议，并且不接受这些条款，那么，只要你在购买之日起三十（30）日内退回未使用过的软件及付款凭证，你便可以得到你购买软件付款的全额退款（如有）。

- 1. 许可证的授予。** 本协议向你授予一种非独占、不可转让、不可转授的许可，从而使你有权根据情况需要，以用户文档中规定的目标码格式，在设备或电脑安装并使用一（1）份指定版本的软件，专供个人使用。当软件装入电脑或设备的临时或永久内存（即随机存取内存、硬盘等）时，软件即为“在使用中”。
- 2. 所有权。** 软件仅授权供你使用，并非销售给你。本协议只授予你使用软件的权利，除本协议所规定的权利之外，你并未获得软件的任何其他明示或暗示权利。飞利浦及其许可人保留对软件拥有的一切权利、权属和权益，包括软件中所包含的一切专利、版权、商业秘密和其他知识产权。软件受版权法、国际条约条款及其他知识产权法律的保护。因此，除本协议明确规定之外，未经飞利浦事先书面授权，不得复制软件，但制作一（1）份拷贝仅供备份之用除外。也不得复制软件附带的任何印刷材料，对于以电子方式提供的任何用户文档，打印也不得超过一（1）份，但制作上述打印材料一（1）份副本仅供备份之用除外。
- 3. 许可限制。** 除本协议另有规定外，不得租用、出租、转授许可、出售、转让、出借或以其他方式转让软件。不得和不得允许任何第三方对软件进行反向工程、反编译或反汇编，但有关法律明确禁止前述限制的情况除外。不得消除或销毁软件上的任何产品标识、版权通知或其他专有标志或限制。应在软件备份上复制所有权属、商标及版权和有限权限通知。不得修改或改编软件，不得将软件合并到其他程序中，或在软件的基础上生成衍生产品。
- 4. 免责声明。** 本软件旨在协助你进行资料传输，你要拥有资料的版权或已经从版权所有人处获得持有并传输的许可。除非你拥有版权或已经从版权所有人处获得持有并传输的许可，你可能会违反版权法，且可能要支付任何赔偿金和其他补偿。如果你不确定自己的权利，应该联系你的法律顾问。你对软件的使用承担全部法律责任和义务。
- 5. 第三方免责声明和WM-DRM限制：** 内容提供商正利用Windows媒体数字权利管理技术（“WM-DRM”），保护其内容的完整性（以下称“安全内容”），从而使其上述内容的知识产权，包括版权不会被盗用。本软件的部分内容和其他第三方应用程序也可以使用WM-DRM软件来传输或播放安全内容（以下称“WM-DRM软件”）。如果上述WM-DRM软件的安全受到损害，微软可以（自行或根据安全内容所有人（以下称“安全内容所有人”）的请求）撤销WM-DRM软件获得复制、储存、传输、显示和/或播放安全内容新许可的权利。撤销不改变WM-DRM软件播放未保护内容的能力。当你下载安全内容许可时，系统会向你的电脑和/或设备发出一份已撤销WM-DRM软件的列表。微软还可以与上述许可一起，代表安全内容所有人将撤销列表下载到

你的设备上。安全内容所有人也可能要求你在使用其内容之前对随本软件一起销售的某些WM-DRM组件进行升级（以下称“WM-DRM升级”）。在你尝试播放安全内容时，由微软编写的WM-DRM软件会通知你需要进行WM-DRM升级，然后要求你在下载WM-DRM升级之前同意升级。由第三方使用的WM-DRM软件也可以这样做。如果你拒绝升级，就无法使用需要WM-DRM升级的安全内容；但是，仍然可以使用未保护的内容和不需要升级的安全内容。

6. **开放源码软件。** (a) 本软件可能包含受设备附属文件中所述之“开放源码条款”约束的组件。本协议不适用于此类软件。(b) 你根据本协议获得的许可权不包括以可能会使软件受到开放源码条款约束的任何方式使用、经销或生成软件衍生产品的任何权利或许可。“开放源码条款”系指直接或间接 (1) 形成或旨在形成飞利浦对软件和/或其衍生产品的义务；或 (2) 向任何第三方授予或旨在授予软件或其衍生产品的知识产权或专有权利项下的任何权利或豁免的任何许可条款。
7. **协议的终止。**本协议应自安装或首次使用软件之日起生效，并且应 (i) 由飞利浦酌定，在你未能遵守本协议任何条款之时；或 (ii) 在销毁飞利浦依据本协议向你提供的软件及相关材料的所有副本之后终止。飞利浦的权利和贵方义务在本协议终止之后仍然有效。
8. **升级。**飞利浦可以自行选择通过在网站上发普通帖子或通过任何其他手段或方法为现有可用软件进行升级。此种升级可以根据本协议条款进行，或者在向你提供此种升级时可能需要你接受其他协议。
9. **支持服务。**飞利浦没有义务为软件提供技术或其他支持（以下称“支持服务”）。如果飞利浦向你提供支持服务，则将受你和飞利浦之间另外约定的条款管辖。
10. **软件有限担保。**飞利浦“按现状”提供软件，而且，除软件将完全根据其所附文档在你首次下载、安装或使用软件之日（以先发生的时间为准）起一年期间内运行之外，没有任何其他保证。如果违反本保证，飞利浦的全部责任和你的唯一补救应为，由飞利浦选择，(i) 退还你为软件支付的费用（如有）；或 (ii) 修理或更换不符合本协议中所述保证且连同你的收据副本一起退还飞利浦的软件。如果由于任何意外、违反操作规程、误用或错误的应用程序造成软件故障，本有限担保无效。对更换软件的担保期应为原担保期的剩余期限或三十（30）天，以较长的时间为准。如果只是鉴于评估而免费向你提供的软件，则本有限担保不适用。
11. **免责条款。**除上述担保之外，飞利浦及其许可人不保证软件的运行不会出现错误或中断，也不保证其符合你的要求。对于选择软件来实现你的预期目标，软件的安装、使用以及由软件得到的结果，贵方应承担全部责任。在有关法律允许的最大限度内，飞利浦及其许可人拒绝承认一切明示或暗示的保证和条件，包括但不限于对某种用途的适销性、适应性以及对有关软件及随附材料结果准确性或完整性的保证和条件。无不侵权保证。飞利浦不保证你能够下载、复制、存储、显示、传输和/或播放安全内容。
12. **责任限制。**无论如何，对于任何性质的一切后果性的、特殊的、间接的、意外的或惩罚性的损害，飞利浦或其许可人概不负责，包括但不限于因利润或营业收入损失，因业务中断，因业务信息丢失，因数据丢失，因使用损失或其他金钱损失而造成的损害赔偿，即使飞利浦或其许可人已得到有关此种损害存在可能性的通知。无论如何，飞利浦或其许可人对因本协议引起的损害赔偿的累积责任不得超过你为软件实际支付的价格或人民币五十元（50.00），以价高者为准。
13. **商标。**本协议、软件及打印的用户文档中使用的某些产品和飞利浦名称都可能构成飞利浦、其许可人或其他第三方的商标。你无权使用上述任何商标。
14. **出口管理。**你同意直接或间接将软件出口或再出口到《美国出口管理法》或任何类似美国法律或法规要求出口许可或其他美国政府审批的任何国家，除非已首先获得适当出口许可或审批。下载或安装软件即意味着你同意遵守本出口规定。

15. **适用法律。**本协议受您居住国法律的管辖，不适用任何冲突法原则。你和飞利浦之间关于本协议的一切纠纷，均应受您居住国法院的非专属管辖。
16. **一般条款。**本协议包含你与飞利浦之间的全部协议，并且取代你和飞利浦之间关于软件 and 用户文档问题的先前所有陈述、承诺或其他通信或广告。如果认定本协议的任何部分无效，则本协议的其余部分仍应完全有效。本协议不应损害作为消费者参与交易的任何一方当事人的法定权利。







