

Register your product and get support at
www.philips.com/welcome



Thank you for choosing Philips.

Need help fast?

Read your Quick Start Guide and/or User Manual first for quick tips that make using your Philips product more enjoyable.

If you have read your instructions and still need assistance, you may access our online help at

www.philips.com/welcome or call

1-888-PHILIPS (744-5477) while with your product.

(and Model / Serial number)



Philips vous remercie de votre confiance.

Besoin d'une aide rapide?

Le Guide rapide de début et Manuel de l'utilisateur regorgent d'astuces destinées à simplifier l'utilisation de votre produit Philips. Toutefois, si vous ne parvenez pas à résoudre votre problème, vous pouvez accéder à notre aide en ligne à l'adresse

www.philips.com/welcome ou formez le

1-800-661-6162 (Francophone)

1-888-PHILIPS (744-5477) (English speaking)

Veillez à avoir votre produit à portée de main.

(et model / serial nombre)



Gracias por escoger Philips

Necesita ayuda inmediata?

Lea primero la Guía rápida del comienzo o el Manual del usuario, en donde encontrarán consejos que le ayudarán a disfrutar plenamente de su producto Philips.

Si después de leerlo aún necesita ayuda, consulte nuestro servicio de asistencia en línea en

www.philips.com/welcome o llame al teléfono

1-888-PHILIPS (744-5477)

y tenga a mano el producto. (y número de model / serial)



PHILIPS

Note : This equipment has been tested and found to comply with the limits for a Class B digital device, pursuant to part 15 of the FCC Rules. These limits are designed to provide reasonable protection against harmful interference in a residential installation. This equipment generates, uses, and can radiate radio frequency energy and, if not installed and used in accordance with the instruction manual, may cause harmful interference to radio communications. However, there is no guarantee that interference will not occur in a particular installation. If this equipment does cause harmful interference to radio or television reception, which can be determined by turning the equipment off and on, the user is encouraged to try to correct the interference by one or more of the following measures :

- Relocate the receiving antenna.
- Increase the separation between the equipment and receiver
- Connect the equipment into an outlet on a circuit different from that to which the receiver is connected.
- Consult the dealer or an experienced radio/TV technician for help.

IMPORTANT !

modifications not authorized by the manufacturer may void users authority to operate this device.

Remarque : Cet équipement a été testé et a été certifié conforme aux limites imposées pour un appareil numérique de Classe B, conformément à la partie 15 des règlements FCC. Ces limites sont définies aux fins d'assurer une protection raisonnable contre les interférences nuisibles dans une installation résidentielle. Cet équipement génère, utilise et émet des fréquences radio qui, en cas d'une mauvaise installation ou d'une utilisation non-conforme aux instructions de ce manuel d'utilisation peuvent causer des interférences nuisibles aux communications radio. Il n'y a toutefois aucune garantie que des interférences nuisibles ne se produiront pas dans une installation donnée. Si cet équipement cause des interférences nuisibles avec votre poste radio ou de télévision, ce que vous pouvez déterminer en éteignant et en rallumant votre équipement, il est conseillé à l'utilisateur d'essayer de pallier à ces interférences nuisibles en prenant l'une ou l'autre des mesures suivantes:

- Changez la position de l'antenne de réception.
- Augmentez la séparation entre l'équipement et le récepteur.
- Branchez l'équipement sur une source d'alimentation différente de celle sur laquelle le récepteur est branché.
- Consultez votre distributeur ou un technicien qualifié en la matière pour assistance.

IMPORTANTE !

las modificaciones no autorizadas por el fabricante pueden anular la autoridad de los usuarios para utilizar este aparato.

Nota : Este aparato ha sido probado y cumple con los límites correspondientes a un aparato digital de Clase B, según la parte 15 de las Normas FCC. Estos límites han sido diseñados para facilitar suficiente protección frente a interferencias perjudiciales en una instalación residencial. Este aparato genera, utiliza y puede emitir energía de frecuencias de radio y, si no se instala y utiliza según el manual de instrucciones, puede provocar interferencias perjudiciales en las comunicaciones de radio. Sin embargo, no existe garantía de que las interferencias no ocurrirán en una instalación particular. Si este aparato provoca interferencias perjudiciales en la recepción de radio o televisión, que se puede identificar encendiendo y apagando el aparato, recomendamos al usuario que intente solucionar las interferencias siguiendo una o más de las siguientes medidas:

- Cambie la posición de la antena receptora.
- Aumente la separación entre el aparato y el receptor.
- Conecte el aparato a una toma de un circuito diferente al que está conectado el receptor.
- Consulte con el distribuidor o un técnico de radio/TV con experiencia para que le ayuden.

¡IMPORTANTE!

modificações não autorizadas pelo fabricante, podem causar danos na operação deste aparelho.

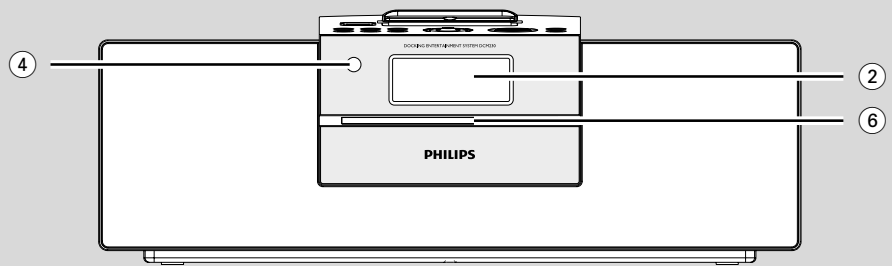
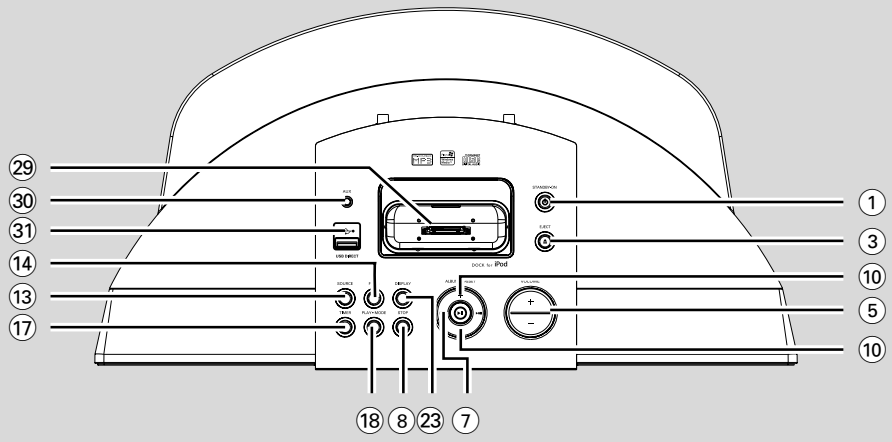
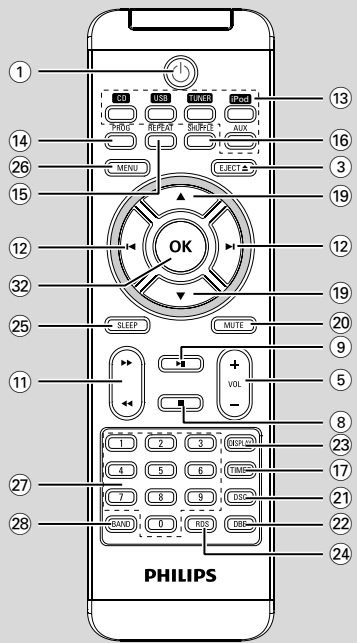

Canada

English:

This digital apparatus does not exceed the Class B limits for radio noise emissions from digital apparatus as set out in the Radio Interference Regulations of the Canadian Department of Communications.

Français:

Cet appareil numérique n'émet pas de bruits radioélectriques dépassant les limites applicables aux appareils numériques de Class B prescrites dans le Règlement sur le Brouillage Radioélectrique édicté par le Ministère des Communications du Canada.

Windows Media is a trademark of Microsoft Corporation.

CAUTION

Use of controls or adjustments or performance of procedures other than herein may result in hazardous radiation exposure or other unsafe operation.

ATTENTION

L'utilisation des commandes ou réglages ou le non respect des procédures ci-incluses peuvent se traduire par une exposition dangereuse à l'irradiation.

ATENCIÓN

El uso de mando o ajustes o la ejecución de métodos que no sean los aquí descritos puede ocasionar peligro de exposición a radiación.

English 6

Français 29

Español 52

English

Français

Español

Contents

General Information

Environmental Information	9
Supplied accessories	9
Safety Information	9
Hearing Safety	10

Preparations

Rear connections	11
Connecting a USB device or memory card	12
Connecting other equipment to your system	12
Before using the remote control	13
Replacing battery (lithium CR2025) into the remote control	13

Controls

Controls on the system and remote control	14~15
---	-------

Basic Functions

Switching the system on	16
Switching the system to Eco Power Standby mode	16
Power Saving Automatic Standby	16
Adjusting volume and sound	16

CD/MP3-CD Operation

Loading a disc	17
Basic playback controls	17
Playing an MP3/WMA disc	18
Different play modes: SHUFFLE and REPEAT	19
Programming track numbers	19
Erasing the program	19

Radio Reception

Tuning to radio stations	20
Programming radio stations	20
Automatic programming	20
Manual programming	20
Tuning to preset radio stations	20

External Sources

Using a non-USB device	21
Using a USB mass storage device	21

Clock/Timer

Clock setting	23
---------------------	----

Timer setting	23
Activating and deactivating timer	23
Sleep timer setting	24

iPod Dock

Compatible iPod players	25
Selecting the correct dock adaptor	25
Setup	25
Playing an iPod portable player	25
Charging iPod battery using the dock	25

Specifications

.....	26
-------	----

Maintenance

.....	26
-------	----

Troubleshooting

.....	27~28
-------	-------

Return your Product Registration Card or register online at
www.philips.com/welcome today to get the very most from your purchase.

Registering your model with PHILIPS makes you eligible for all of the valuable benefits listed below, so don't miss out. Complete and return your Product Registration Card at once, or register online at www.philips.com/welcome to ensure:

*Proof of Purchase

Returning the enclosed card guarantees that your date of purchase will be on file, so no additional paperwork will be required from you to obtain warranty service.

*Product Safety Notification

By registering your product, you'll receive notification - directly from the manufacturer - in the rare case of a product recall or safety defect.

*Additional Benefits

Registering your product guarantees that you'll receive all of the privileges to which you're entitled, including special money-saving offers.

PHILIPS

Congratulations on your purchase, and welcome to the "family!"

Dear PHILIPS product owner:

Thank you for your confidence in PHILIPS. You've selected one of the best-built, best-backed products available today. We'll do everything in our power to keep you happy with your purchase for many years to come.

As a member of the PHILIPS "family," you're entitled to protection by one of the most comprehensive warranties and outstanding service networks in the industry. What's more, your purchase guarantees you'll receive all the information and special offers for which you qualify, plus easy access to accessories from our convenient home shopping network.

Most importantly, you can count on our uncompromising commitment to your total satisfaction.

All of this is our way of saying welcome - and thanks for investing in a PHILIPS product.

P.S. To get the most from your PHILIPS purchase, be sure to complete and return your Product Registration Card at once, or register online at:

www.philips.com/welcome

Know these

safety symbols



 This "bolt of lightning" indicates uninsulated material within your unit may cause an electrical shock. For the safety of everyone in your household, please do not remove product covering.

 The "exclamation point" calls attention to features for which you should read the enclosed literature closely to prevent operating and maintenance problems.

WARNING: To reduce the risk of fire or electric shock, this apparatus should not be exposed to rain or moisture and objects filled with liquids, such as vases, should not be placed on this apparatus.

CAUTION: To prevent electric shock, match wide blade of plug to wide slot, fully insert.

ATTENTION: Pour éviter les choc électriques, introduire la lame la plus large de la fiche dans la borne correspondante de la prise et pousser jusqu'au fond.

For Customer Use

Enter below the Serial No. which is located on the rear of the cabinet. Retain this information for future reference.

Model No. _____

Serial No. _____

PHILIPS

Visit our World Wide Web Site at <http://www.philips.com/welcome>

PHILIPS LIMITED WARRANTY ONE (1) YEAR

WARRANTY COVERAGE:

PHILIPS warranty obligation is limited to the terms set forth below.

WHO IS COVERED:

Philips warrants the product to the original purchaser or the person receiving the product as a gift against defects in materials and workmanship as based on the date of original purchase ("Warranty Period") from an Authorized Dealer. The original sales receipt showing the product name and the purchase date from an authorized retailer is considered such proof.

WHAT IS COVERED:

The Philips warranty covers new products if a defect in material or workmanship occurs and a valid claim is received by Philips within the Warranty Period. At its option, Philips will either (1) repair the product at no charge, using new or refurbished replacement parts, or (2) exchange the product with a product that is new or which has been manufactured from new, or serviceable used parts and is at least functionally equivalent or most comparable to the original product in Philips current inventory, or (3) refund the original purchase price of the product. Philips warrants replacement products or parts provided under this warranty against defects in materials and workmanship from the date of the replacement or repair for ninety (90) days or for the remaining portion of the original product's warranty, whichever provides longer coverage for you. When a product or part is exchanged, any replacement item becomes your property and the replaced item becomes Philips' property. When a refund is given, your product becomes Philips' property.

Note: Any product sold and identified as refurbished or renewed carries a ninety (90) day limited warranty.

Replacement product can only be sent if all warranty requirements are met. Failure to follow all requirements can result in delay.

WHAT IS NOT COVERED - EXCLUSIONS AND LIMITATIONS:

This Limited Warranty applies only to the new products manufactured by or for Philips that can be identified by the trademark, trade name, or logo affixed to it. This Limited Warranty does not apply to any non-Philips hardware product or any software, even if packaged or sold with the product. Non-Philips manufacturers, suppliers, or publishers may provide a separate warranty for their own products packaged with the bundled product.

Philips is not liable for any damage to or loss of any programs, data, or other information stored on any media contained within the product, or any non-Philips product or part not covered by this warranty. Recovery or reinstallation of programs, data or other information is not covered under this Limited Warranty.

This warranty does not apply (a) to damage caused by accident, abuse, misuse, neglect, misapplication, or non-Philips product, (b) to damage caused by service performed by anyone other than Philips or Philips Authorized Service Location, (c) to a product or a part that has been modified without the written permission of

Philips, or (d) if any Philips serial number has been removed or defaced, or (e) product, accessories or consumables sold "AS IS" without warranty of any kind by including refurbished Philips product sold "AS IS" by some retailers.

This Limited Warranty does not cover:

- Shipping charges to return defective product to Philips.
- Labor charges for installation or setup of the product, adjustment of customer controls on the product, and installation or repair of antenna/signal source systems outside of the product.
- Product repair and/or part replacement because of improper installation or maintenance, connections to improper voltage supply, power line surge, lightning damage, retained images or screen markings resulting from viewing fixed stationery content for extended periods, product cosmetic appearance items due to normal wear and tear, unauthorized repair or other cause not within the control of Philips.
- Damage or claims for products not being available for use, or for lost data or lost software.
- Damage from mishandled shipments or transit accidents when returning product to Philips.
- A product that requires modification or adaptation to enable it to operate in any country other than the country for which it was designed, manufactured, approved and/or authorized, or repair of products damaged by these modifications.
- A product used for commercial or institutional purposes (including but not limited to rental purposes).
- Product lost in shipment and no signature verification receipt can be provided.
- Failure to operate per Owner's Manual.

TO OBTAIN ASSISTANCE IN THE U.S.A., PUERTO RICO, OR U.S. VIRGIN ISLANDS...

Contact Philips Customer Care Center at:
1-888-PHILIPS (1-888-744-5477)

TO OBTAIN ASSISTANCE IN CANADA...

1-800-661-6162 (French Speaking)
1-888-PHILIPS (1-888-744-5477) - (English or Spanish Speaking)

REPAIR OR REPLACEMENT AS PROVIDED UNDER THIS WARRANTY IS THE EXCLUSIVE REMEDY FOR THE CONSUMER. PHILIPS SHALL NOT BE LIABLE FOR ANY INCIDENTAL OR CONSEQUENTIAL DAMAGES FOR BREACH OF ANY EXPRESS OR IMPLIED WARRANTY ON THIS PRODUCT, EXCEPT TO THE EXTENT PROHIBITED BY APPLICABLE LAW, ANY IMPLIED WARRANTY OF MERCHANTABILITY OR FITNESS FOR A PARTICULAR PURPOSE ON THIS PRODUCT IS LIMITED IN DURATION TO THE DURATION OF THIS WARRANTY.

Some states do not allow the exclusions or limitation of incidental or consequential damages, or allow limitations on how long an implied warranty lasts, so the above limitations or exclusions may not apply to you.

This warranty gives you specific legal rights. You may have other rights which vary from state/province to state/province.

Philips, P.O. Box 10313 Stamford, CT 06904

3140 035 50201

Congratulations on your purchase and welcome to Philips!

To fully benefit from the support that Philips offers, register your product at www.philips.com/welcome.

This set complies with the FCC rules, Part 15 and with 21 CFR 1040.10.

Operation is subject to the following two conditions:

- ***This device may not cause harmful interference, and***
- ***This device must accept any interference received, including interference that may cause undesired operation.***

Environmental Information

All unnecessary packaging has been omitted. We have tried to make the packaging easy to separate into three materials: cardboard (box), polystyrene foam (buffer) and polyethylene (bags, protective foam sheet).

Your system consists of materials which can be recycled and reused if disassembled by a specialized company. Please observe the local regulations regarding the disposal of packaging materials, exhausted batteries and old equipment.

Supplied accessories

- remote control (with battery)
- FM antenna
- AM antenna
- 4 X iPod dock adaptors
- 1 X certified AC/DC adapter (Input: 100-240V ~ 50-60Hz 1.2 A, Output: 15V  3A)

Safety Information

- Before operating the system, check that the operating voltage indicated on the typeplate of your system is identical with the voltage of your local power supply. If not, please consult your dealer.
- Place the system on a flat, hard and stable surface.
- Where the MAINS plug or an appliance coupler is used as the disconnnet device, the disconnnet device shall remain readily operable.

- Place the system in a location with adequate ventilation to prevent internal heat build-up in your system. Allow at least 10 cm (4 inches) clearance from the rear and the top of the unit and 5 cm (2 inches) from each side.
- The ventilation should not be impeded by covering the ventilation openings with items, such as newspapers, table-cloths, curtains, etc.
- Do not expose the system, batteries or discs to excessive moisture, rain, sand or heat sources caused by heating equipment or direct sunlight.
- No naked flame sources, such as lighted candles, should be placed on the apparatus.
- No objects filled with liquids, such as vases, shall be placed on the apparatus.
- Install this unit near the AC outlet and where the AC power plug can be reached easily.
- The apparatus shall not be exposed to dripping or splashing.
- If the system is brought directly from a cold to a warm location, or is placed in a very damp room, moisture may condense on the lens of the disc unit inside the system. Should this occur, the CD player would not operate normally. Leave the power on for about one hour with no disc in the system until normal playback is possible.
- The mechanical parts of the set contain self-lubricating bearings and must not be oiled or lubricated.
- Batteries (battery pack or batteries installed) shall not be exposed to excessive heat such as sunshine, fire or the like.
- **When the system is switched to Standby mode, it is still consuming some power. To disconnect the system from the power supply completely, remove the AC power plug from the wall socket.**

Hearing Safety

Listen at a moderate volume.

- Using headphones at a high volume can impair your hearing. This product can produce sounds in decibel ranges that may cause hearing loss for a normal person, even for exposure less than a minute. The higher decibel ranges are offered for those that may have already experienced some hearing loss.
- Sound can be deceiving. Over time your hearing "comfort level" adapts to higher volumes of sound. So after prolonged listening, what sounds "normal" can actually be loud and harmful to your hearing. To guard against this, set your volume to a safe level before your hearing adapts and leave it there.

To establish a safe volume level:

- Set your volume control at a low setting.
- Slowly increase the sound until you can hear it comfortably and clearly, without distortion.

Listen for reasonable periods of time:

- Prolonged exposure to sound, even at normally "safe" levels, can also cause hearing loss.
- Be sure to use your equipment reasonably and take appropriate breaks.

Be sure to observe the following guidelines when using your headphones.

- Listen at reasonable volumes for reasonable periods of time.
- Be careful not to adjust the volume as your hearing adapts.
- Do not turn up the volume so high that you can't hear what's around you.
- You should use caution or temporarily discontinue use in potentially hazardous situations.
- Do not use headphones while operating a motorized vehicle, cycling, skateboarding, etc.; it may create a traffic hazard and is illegal in many areas.

Your product is designed and manufactured with high quality materials and components, which can be recycled and reused.

Never dispose of your product with other household waste. Please inform yourself about the local rules on the separate collection of electrical and electronic products and batteries. The correct disposal of these products helps prevent potentially negative consequences on the environment and human health.

Your product contains batteries, which cannot be disposed of with normal household waste. Please inform yourself about the local rules on separate collection of batteries. The correct disposal of batteries helps prevent potentially negative consequences on the environment and human health.

Please visit www.recycle.philips.com for additional information on a recycling center in your area.

Perchlorate Material - special handling may apply. See www.dtsc.ca.gov/hazardouswaste/perchlorate.

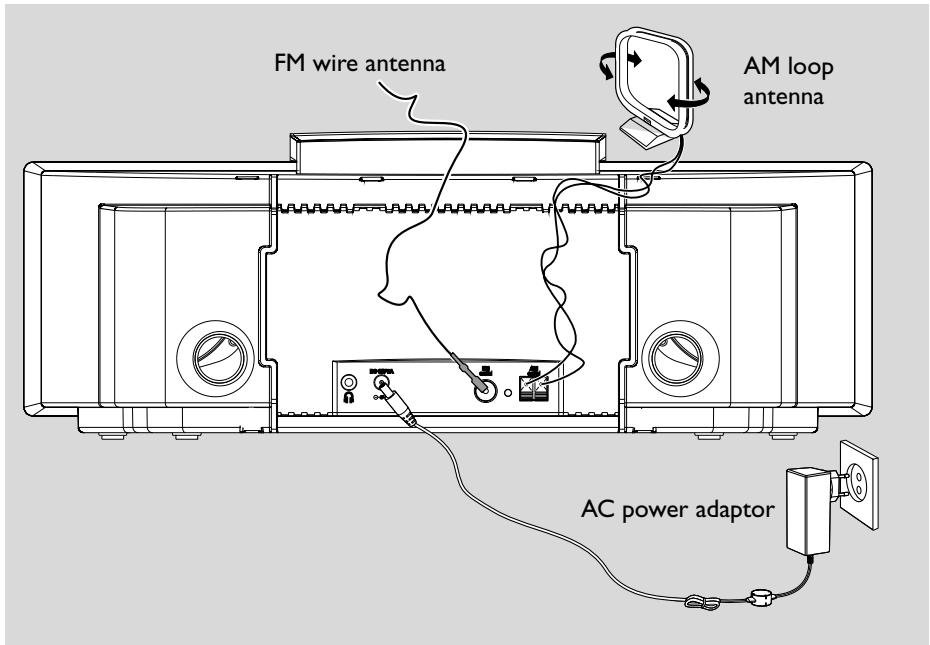

Rear connections

The type plate is located at the rear of the system.

A Power

- Before connecting the AC power adaptor to the wall outlet, ensure that all other connections have been made.

WARNING!

- For optimal performance, use only the original AC power adaptor.
- Never make or change connections with the power switched on.

To avoid overheating of the system, a safety circuit has been built in. Therefore, your system may switch to Standby mode automatically under extreme conditions. If this happens, let the system cool down before reusing it (not available for all versions).

B Antennas Connection

Connect the supplied AM loop antenna and FM antenna to the respective terminals. Adjust the position of the antenna for optimal reception.

AM Antenna

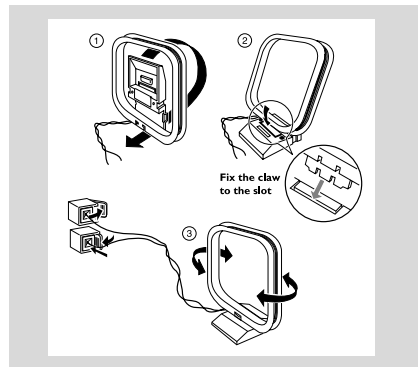

- Position the antenna as far as possible from a TV, VCR or other radiation source.

Preparations

FM Antenna

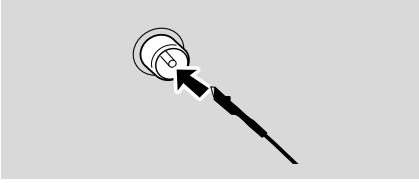

- For better FM stereo reception, connect an outdoor FM antenna to the FM AERIAL (FM ANTENNA) terminal.

C Optional connection

The optional equipment and connecting cords are not supplied. Refer to the operating instructions of the connected equipment for details.

Connecting a USB device or memory card

By connecting a USB mass storage device (including USB flash memory, USB flash players or memory cards) to the Hi-Fi system, you can enjoy the device's stored music through the powerful speakers of Hi-Fi system.

- Insert the USB device's USB plug into the  socket on the set.

OR

for the devices with USB cables:

- 1 Insert one plug of the USB cable (not supplied) to the  socket on the set.
- 2 Insert the other plug of the USB cable to the USB output terminal of the USB device.

OR

for the memory card:

- 1 Insert the memory card into a card reader (not supplied).
- 2 Use a USB cable (not supplied) to connect the card reader into the  socket on the set.

Connecting other equipment to your system

- Use a cinch cable to connect AUX to the analogue audio out terminals of an external equipment (TV, VCR, Laser Disc player, DVD player or CD Recorder).

Note:

– If you are connecting equipment with a mono output (a single audio out terminal), connect it to the AUX left terminal. Alternatively, you can use a "single to double" cinch cable (the output sound still remain mono).

Before using the remote control

- 1 Pull out the plastic protective sheet.
- 2 Select the source you wish to control by pressing one of the source select keys on the remote control (for example DISC, FM).
- 3 Then select the desired function (for example ► II , ◀◀ , ▶▶).

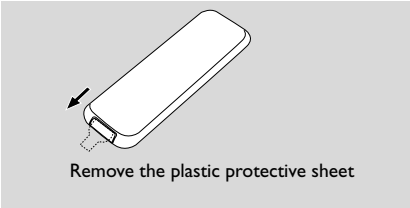

Replacing battery (lithium CR2025) into the remote control



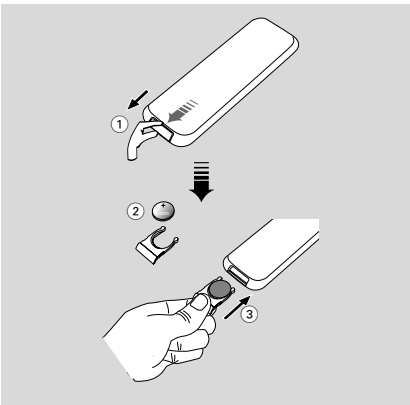

- 1 Press the slot on the battery compartment.
- 2 Pull out the battery compartment.
- 3 Replace a new battery and fully insert the battery compartment back to the original position.



CAUTION!

- Remove battery if it is exhausted or will not be used for a long time.
- Battery contains chemical substances, so they should be disposed of properly.
- Perchlorate Material-special handling may apply. See www.dtsc.ca.gov/hazardouswaste/perchlorate.

Controls on the system and remote control

- ① **STANDBY-ON/ECO POWER** 
 - switches the system on or to Eco Power standby/normal standby with clock display.
- ② **Display screen**
 - shows the status of the system.
- ③ **EJECT** 
 - ejects a disc from the disc loader.
- ④ **IR SENSOR**
 - remote sensor
- ⑤ **VOLUME -/+ (VOL +/-)**
 - adjusts the volume level.
- ⑥ **Disc loader**
- ⑦ 
 - for CD/MP3-CD/WMA/USB
 - fast searches back and forward within a track/disc (press and hold).
 -skips to the beginning of a current/previous/subsequent track.
- ⑧ **STOP** 
 - stops disc playback or erases a disc program.
- ⑨ 
 - starts or interrupts playback.
- ⑩ **ALBUM/PRESET +/-**
 - (for MP3-CD/WMA/USB) skips to the beginning of a current/previous/subsequent album.
 - adjusts the hours and minutes for the clock/timer function.
 - selects a preset radio station.
- ⑪ 
 - for CD/MP3-CD/WMA/USB
 - fast searches back and forward within a track/disc (press and hold).
 - for TUNERtunes to radio stations (down/up).
- ⑫ 
 - for CD/MP3-CD/WMA/USB
 -skips to the beginning of a current/previous/subsequent track.

- ⑬ **SOURCE**
 - selects the respective sound source for CD/USB/iPod/TUNER (FM/AM)/AUX.
- ⑭ **PROG**
 - (for CD/MP3/WMA/USB) programs tracks.
 - (for TUNER) programs radio stations.
 - sets the clock function.
- ⑮ **REPEAT**
 - for CD/MP3/WMA/USB selects a repeat playback mode.
- ⑯ **SHUFFLE**
 - plays disc/USB tracks randomly.
- ⑰ **TIMER**
 - sets the timer function.
- ⑱ **PLAY•MODE**
 - selects various repeat modes or the shuffle play mode for a disc.
- ⑲ 
 - (for MP3-CD/WMA/USB) skips to the beginning of a current/previous/subsequent album.
- ⑳ **MUTE**
 - interrupts and resumes sound production.
- ㉑ **DSC (Digital Sound Control)**
 - selects sound characteristics: ROCK/POP/JAZZ/CLASSIC.
- ㉒ **DBB (Dynamic Bass Boost)**
 - enhances the bass.
- ㉓ **DISPLAY**
 - selects different disc information display modes during playback.
- ㉔ **RDS (no function on this version)**
- ㉕ **SLEEP**
 - selects the sleeper time.

26 MENU

- equivalent to the MENU button on your iPod player.

27 Numerical Keypad (0~9)

- (for CD/MP3/WMA/USB) selects a track directly.

28 BAND

- For tuner (TUNER): press to switch between AM and FM.

29 iPod dock

- is used to dock your iPod player for playback or recharging through this system.

30 AUX

- is the jack used to connect an auxiliary device.



31 USB DIRECT 

- jack for the external USB mass storage device.

32 OK

- confirms a selection (for iPod menu operation only).

Notes for remote control:

- **First select the source you wish to control by pressing one of the source select keys on the remote control (for example CD, FM).**
- **Then select the desired function (for example , , .**

Basic Functions

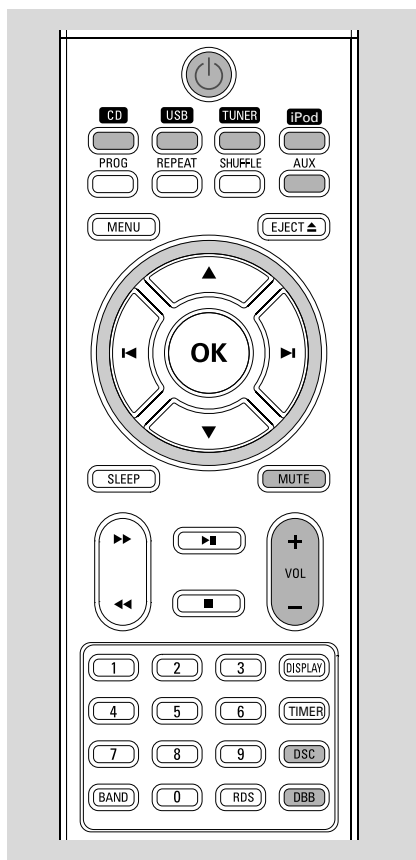

Important!

Before you operate the system, complete the preparation procedures.

Switching the system on

- Press **STANDBY-ON/ECO POWER** (or  on the remote).
→ The system will switch to the last selected source.
- Press **SOURCE** on the top of the system or **CD, USB, iPod, TUNER** or **AUX** on the remote control.
→ The system will switch to the selected source.

Switching the system to standby mode

- Press **STANDBY-ON/ECO POWER** (or  on the remote).
→ The backlight for clock display is dim in standby.
→ The volume level (up to a maximum volume level of 12), interactive sound settings, last selected mode (ECO Power Standby or normal standby), source and tuner presets will be retained in the player's memory.

Switching the system to Eco Power Standby mode

- Press and hold **STANDBY-ON/ECO POWER** (or  on the remote) for more than 2 seconds.
→ The backlight will go blank.

Power Saving Automatic Standby

As a power-saving feature, the system automatically switches to Eco Power/ Standby 15 minutes after a CD/MP3/WMA/USB playback has reached the end and no control is operated.

Adjusting volume and sound

- 1 Press **VOLUME +/-** (or **VOL +/-** on the remote control) to decrease or increase the volume.
→ Display shows the volume level VOL and a number from MIN 01, 02, ...31 MAX.
 - 2 Press **DSC** repeatedly to select the desired sound effect: **ROCK/POP/JAZZ/CLASSIC**.
 - 3 Press **DBB** to switch bass enhancement on or off.
→ If the DBB is activated, **DBB ON** is shown.
→ If the DBB is deactivated, **DBB OFF** is shown.
 - 4 Press **MUTE** on the remote control to interrupt sound reproduction instantly.
→ Playback will continue without sound and **MUTE** will flash on the display.
- To activate sound reproduction you can:
 - press **MUTE** again;
 - adjust the volume controls;
 - change source.

To listen through the headphone

- Connect the headphone plug to the  socket on the rear of the set.
→ The speakers will be muted.

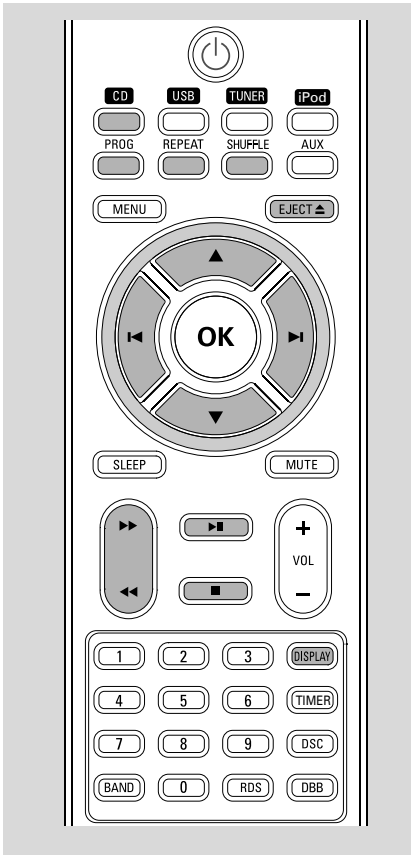

Important!
The lens of the CD player should never be touched.

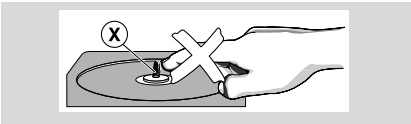

Loading a disc

This CD player plays Audio Discs including CD Recordables, CD-Rewritables and MP3 CD.

- CD-ROM, CD-I, CDV, VCD, DVD or computer CDs, however, are not possible.
- DRM-protected WMA disc is not supported.
- ① Press **SOURCE** on the top of the system to select CD or press **CD** on the remote.

- ② Insert a disc into the disc loader.
→ Make sure the label side is facing up.
→ Make sure you have removed any other disc from the slot loader.
- ③ Press **▶ ||** to start playback.
- ④ At any time, simply press **■** to stop playback.

Basic playback controls

To play a disc

- Press **▶ ||** to start playback.
→ The current track number and elapsed playing time of the track are displayed during disc playback.

To select a different track

- Press **◀◀/▶▶** (or **◀ / ▶** on the remote control) once or repeatedly until the desired track number appears in the display.
- You can also use the **Numerical Keypad (0~9)** on the remote to select a track directly.
- If you have selected a track number shortly after loading a disc or in the PAUSE position, you will need to press **▶ ||** to start playback.

Text display during playback

In CD mode

- Press **DISPLAY** repeatedly to see the following information.
→ Track number and elapsed playback time of current track.
→ Track number and total elapsed playback time.
→ Track number and remaining playback time of current track.
→ Track number and total remaining playback time.
→ Clock time.

In MP3-CD mode

- Press **DISPLAY** to display the ID-3 information if available and the clock time.

CD/MP3-CD Operation

To find a passage within a track

- 1 Press and hold **|◀◀/▶▶|** (or **◀◀/▶▶** on the remote control).
- 2 When you recognize the passage you want, release **|◀◀/▶▶|** (or **◀◀/▶▶** on the remote control).
→ Normal playback continues.

To stop playback

- Press **■**.

To interrupt playback

- Press **▶ ||** during playback.
→ The display freezes and the elapsed playing time flashes when playback is interrupted.
→ To resume, press **▶ ||** again.

Notes:

CD play will also stop when;

- *you eject the disc.*
- *the disc has reached the end.*
- *you select another source: TUNER, USB, DOCK or AUX.*
- *you select standby.*
- *the set auto off time expires.*

Playing an MP3/WMA disc

- 1 Load an MP3/WMA disc.
→ The disc reading time may exceed 10 seconds due to the large number of songs compiled into one disc.
- 2 Press **ALBUM/PRESET +/-** (or **▲ / ▼** on the remote control) to select a desired album.
- 3 Press **|◀◀/▶▶|** (or **◀ / ▶** on the remote control) to select a desired track.
→ The album number will change accordingly as you reach the first track of an album by pressing **|◀◀|** (**◀** on the remote) or the last track of an album by pressing **▶▶|** (**▶** on the remote).
- 4 Press **▶ ||** to start playback.

Supported MP3 disc formats:

- ISO9660, Joliet
- Maximum title number: 999 (depending on filename length)
- Maximum album number: 99
- Supported sampling frequencies: 32 kHz, 44.1kHz, 48 kHz
- Supported Bit-rates: 32~256 (kbps), variable bitrates

Different play modes: SHUFFLE and REPEAT

You can select and change the various play modes before or during playback. The REPEAT modes can also be combined with PROGRAM.

- 1 To select your play mode, press **PLAY•MODE** (**SHUFFLE** or **REPEAT** on the remote control) before or during playback until the display shows the desired function.
 - appears if the shuffle playback is activated and disappears if deactivated.
 - If appears, it indicates to play the current track repeatedly.
 - If is displayed, it indicates to play all tracks in the whole disc repeatedly.
 - For an MP3 CD/WMA, if both and flash on the display panel, it indicates to play the current album repeatedly.
- 2 Press to start playback if in the STOP position.
 - If you have selected SHUFFLE, playback starts automatically.
- 3 To return to normal playback, press the **PLAY•MODE** (**SHUFFLE** or **REPEAT** on the remote control) until or is no longer displayed.
- You can also press to stop playback and cancel your play mode.

Note:

– The Repeat and Shuffle functions cannot be activated simultaneously.

Programming track numbers

Program in the STOP position to select and store your disc tracks in the desired sequence. If you like, store any track more than once. Up to 40 tracks can be stored in the memory.

- 1 Press **PROG** to enter the programming mode.
 - A track number flashes.
- 2 Press (or / on the remote control) to select your desired track number.
 - For an MP3 CD/WMA, press **ALBUM/PRESET +/-** (or / on the remote control) to select a desired album number.
- 3 Press **PROG** to confirm the track number to be stored.
 - *PR X* displays, in which *X* denotes the next program number to be stored.
- 4 Repeat steps 2-3 to select and store all desired tracks.
 - *PROGRAM FULL* appears if you attempt to program more than 40 tracks.
- 5 Press to finish programming.
 - *PROG* displays on the screen.
- 6 To start playback of your disc program, press directly.

Erasing the program

You can erase the program by:

- pressing once in the STOP mode;
- pressing twice during playback;
 - *PROG* disappears.
- ejecting the current disc;

Using a non-USB device

- 1 Connect the audio out terminals of the external equipment (TV, VCR, Laser Disc player, DVD player or CD Recorder) to the AUX terminals of your system.
- 2 Press **SOURCE** repeatedly (or **AUX** on the remote control) to select external equipment.

Notes:

- All the sound control features (DSC or DBB, for example) are available for selection.
- Refer to the operating instructions for the connected equipment for details.

Using a USB mass storage device

By connecting a USB mass storage device to the Hi-Fi system, you can enjoy the device's stored music through the powerful speakers of the Hi-Fi system.

Playing a USB mass storage device Compatible USB mass storage devices

With the Hi-Fi system, you can use:

- USB flash memory (USB 2.0 or USB1.1)
- USB flash players (USB 2.0 or USB1.1)
- memory cards (requires an additional card reader to work with this Hi-Fi system)

Notes:

- In some USB flash players (or memory devices), the stored contents are recorded using copyright protection technology. Such protected contents will be unplayable on any other devices (such as this Hi-Fi system).
- Compatibility of the USB connection on this product:
 - a) This product supports most USB Mass storage devices (MSD) that are compliant to the USB MSD standards.
 - i) Most common Mass storage class devices are flash drives, memory sticks, jump drives and etc.
 - ii) If you see a "Disc Drive" show up on your computer after you plugged the mass storage device into your computer, most likely it is MSD compliant and it will work with this product.

b) If your Mass storage device required a battery/power source. Please make sure you have a fresh battery in it or charge the USB device first and then plug it into the product again.

– Supported Music type:

a) This device only supports unprotected music with the following file extension:

.mp3

.wma

b) Music bought from on-line music stores are not supported because they are secured by Digital Rights Management protection (DRM).

c) File name extensions that end with the following are not supported:

.wav; .m4a; .m4p; .mp4; .aac and etc.

– No Direct connection can be made from Computer USB port to the product even you have either or both mp3 or wma files in your computer.

Supported formats:

- USB or memory file format FAT12, FAT16, FAT32 (sector size: 512 bytes)
- MP3 bit rate (data rate): 32-320 Kbps and variable bit rate
- WMA v9 or earlier
- Directory nesting up to a maximum of 8 levels
- Number of albums/ folders: maximum 99
- Number of tracks/titles: maximum 400
- ID3 tag v2.0 or later
- File name in Unicode UTF8 (maximum length: 128 bytes)

The system will not play or support the following:

- Empty albums: an empty album is an album that does not contain MP3/WMA files, and will not be shown in the display.
- Non-supported file formats are skipped. This means that e.g.: Word documents .doc or MP3 files with extension .dlf are ignored and will not be played.
- AAC, WAV, PCM audio files
- DRM protected WMA files
- WMA files in Lossless format

External Sources

How to transfer music files from PC to a USB mass storage device

By dragging and dropping music files, you can easily transfer your favorite music from PC to a USB mass storage device.

For the flash player, you can also use its music management software for the music transfer.

However, those WMA files may be unplayable for compatibility reasons.

How to organize your MP3/WMA files on the USB mass storage device

This Hi-Fi system will browse the MP3/WMA files in the folders/sub-folders/titles order. Example:

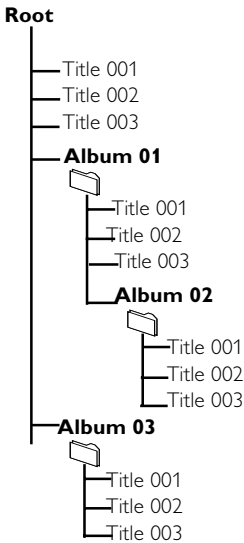

Organize your MP3/WMA files in different folders or subfolders as required.

Notes:

- If you have not organized MP3/WMA files into any albums on your disc, an album "01" will be automatically assigned for all those files.
- Make sure that the file names of MP3 files end with .mp3. and the file names of WMA files end with .wma.
- For DRM protected WMA files, use Windows Media Player 10 (or later) for conversion. Visit www.microsoft.com for details about Windows Media Player and WM DRM (Windows Media Digital Rights Management).

- 1 Check the USB device has been properly connected. (See Installation: Connecting an additional appliance).
- 2 Press **SOURCE (USB)** on the remote once or more to select USB.
 - **NO FILE** appears if no audio file is found in the USB device.
- 3 Play the USB's audio files as you do with the albums/tracks on a CD (See CD/MP3 Operations).

Notes:

- For compatibility reasons, the album/track information may differ from what it is displayed through flash players' music management software.
- File names or ID3 tags will be displayed as — if they are not in English.

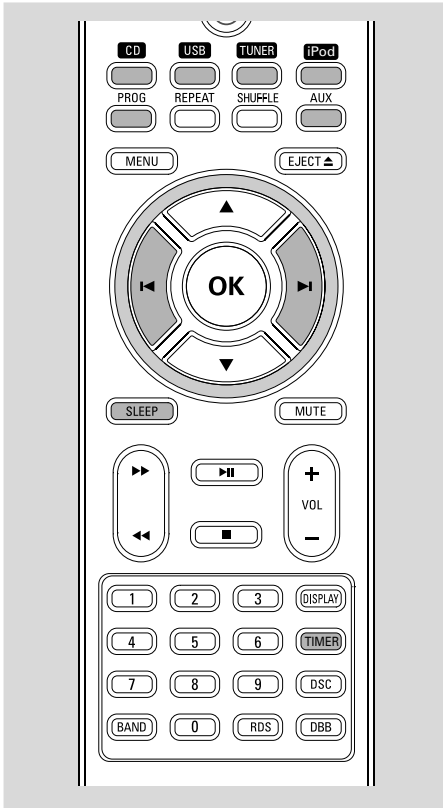

Clock setting

The clock can be set in either 12-hour or 24-hour mode (12HR or 24HR for example).

- 1 In standby mode, press **PROG**.
→ SET CLOCK is displayed briefly. Then, 12HR or 24HR is displayed.
- 2 Press **ALBUM/PRESET +/-** (or ◀ / ▶) on the remote control) to select clock mode.
→ The clock digits for the hours continue to flash.
- 3 Press **ALBUM/PRESET +/-** (or ◀ / ▶) on the remote control) to set the hours.
- 4 Press **PROG** again.
→ The clock digits for the minutes flash.
- 5 Press **ALBUM/PRESET +/-** (or ◀ / ▶) on the remote control) to set the minutes.
- 6 Press **PROG** to confirm the time.

Timer setting

- The system can be used as an alarm clock, whereby the CD, TUNER, USB or DOCK is switched on at a set time (one time operation). The clock time needs to be set first before the timer can be used.
 - During setting, if no button is pressed within 90 seconds, the system will exit timer setting mode automatically.
- 1 Press **TIMER** for more than two seconds.
 - 2 Press **SOURCE** repeatedly to select the sound source.
→ "SET TIMER" and "SELECT SOURCE" are displayed.
 - 3 Press **TIMER** to confirm your desired mode.
→ The clock digits for the hours flash.
 - 4 Press **ALBUM/PRESET +/-** (or ◀ / ▶) on the remote control) to set the hours.
 - 5 Press **TIMER** again.
→ The clock digits for the minutes flash.
 - 6 Press **ALBUM/PRESET +/-** (or ◀ / ▶) on the remote control) to set the minutes.
 - 7 Press **TIMER** to confirm the time.
→ The timer is now set and activated.

Activating and deactivating timer

- In standby or during playback, press **TIMER once** on the remote control.
→ Display shows ⏰ if activated, and disappears if deactivated.

Sleep timer setting

The sleep timer enables the system to switch off by itself after a set period of time.

- 1 Press **SLEEP** on the remote control repeatedly to select a preset time.
→ The selections are as follows (time in minutes):
OFF → 90 → 75 → 60 → 45 → 30 → 15 → OFF → 90 ...
→ "SLEEP xx" is displayed. "xx" is the time in minutes.
→ .x² is displayed if the sleep time you have selected is not OFF.
- 2 When you reach the desired length of time, stop pressing the **SLEEP** button.

To deactivate the sleep timer

- Press **SLEEP** repeatedly until "OFF" is displayed, or press **ECO POWER/STANDBY ON** .

Compatible iPod players

- Most Apple iPod models with 30-pin dock connectors as follows: Nano 1st /2nd/3rd generation, iPod 5th generation (video), iPod touch and iPod classic.

Selecting the correct dock adaptor

- 4 iPod dock adaptors of different type, as indicated at the back of the adaptor; are included to fit the following iPod:
Nano 1st /2nd/3rd generation, iPod 5th generation (video), iPod touch and iPod classic.

Setup

- Insert a dock adaptor corresponding to the portable player you use.

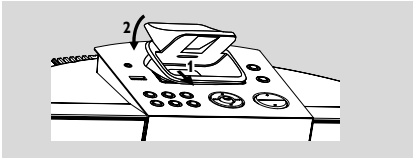

- To connect with a different iPod portable player, pop up the corresponding dock adaptor and replace with a new one of the matching type.

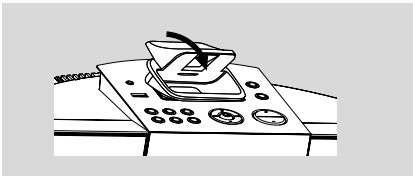

Playing an iPod portable player

- 1 Correctly dock your iPod portable player in the cradle. Make sure the dock adaptor is compatible.
- Make sure that you have powered on your iPod player before selecting DOCK source.
→ On the display, "iPod" is displayed if iPod is connected.
- 2 Press **SOURCE** on the system repeatedly or **iPod** on the remote control to select iPod source.
- 3 Playback starts automatically. You can select available features (such as play/pause, skip track, fast forward/backward, menu selection) during playback.

Charging iPod battery using the dock

- In DOCK mode, directly dock your iPod portable player on the cradle for charging.

Note:

– For the purpose of **SAVING POWER**, recharging of your iPod or USB device is **NOT SUPPORTED** when the main set is in the **STANDBY MODE**.

Specifications

AMPLIFIER

Output power 2 x 15 W RMS
Signal-to-noise ratio ≥ 70 dBA
Frequency response 20 Hz – 20 KHz, ± 3 dB
Input sensitivity AUX 0.5 V (max. 2 V)
Impedance loudspeakers 4 Ω
Impedance headphones 32 Ω
Output power headphones <50 mW

CD PLAYER

Frequency range 20 Hz – 20 kHz
Signal-to-noise ratio 70 dBA

TUNER

FM wave range 87.5 – 108 MHz
Sensitivity at 75 Ω
– FM 20dBf
Selectivity ≥ 25 dB
Total harmonic distortion $\leq 1\%$
Frequency response
– FM 63 – 6000 Hz
Signal-to-noise-ratio
– FM ≥ 50 dBA

USB PLAYER

USB 12Mb/s, V1.1
..... support MP3 and WMA files
Number of albums/folders maximum 99
Number of tracks/titles maximum 400

GENERAL INFORMATION

AC Power 100 – 240 V, 50/60 Hz
Dimensions (w x h x d)
..... 390 x 140.5 x 200.5 (mm)
Weight 2.33 kg
Standby power consumption <7 W
Eco power standby <1 W

Specifications and external appearance are subject to change without notice.

Maintenance

Cleaning the Cabinet

- Use a soft cloth slightly moistened with a mild detergent solution. Do not use a solution containing alcohol, spirits, ammonia or abrasives.

Cleaning Discs

- When a disc becomes dirty, clean it with a cleaning cloth. Wipe the disc from the centre out.
- Do not use solvents such as benzene, thinner, commercially available cleaners, or antistatic spray intended for analogue records.



Cleaning the disc lens

- After prolonged use, dirt or dust may accumulate at the disc lens. To ensure good playback quality, clean the disc lens with Philips CD Lens Cleaner or any commercially available cleaner. Follow the instructions supplied with cleaner.

WARNING

Under no circumstances should you try to repair the system yourself, as this will invalidate the warranty. Do not open the system as there is a risk of electric shock.

If a fault occurs, first check the points listed below before taking the system for repair. If you are unable to remedy a problem by following these hints, consult your dealer or Philips for help.

Problem	Solution
<p>“PLEASE INSERT COMP3 DISC” is displayed.</p>	<ul style="list-style-type: none"> ✓ Insert a disc. ✓ Check if the disc is inserted upside down. ✓ Wait until the moisture condensation at the lens has cleared. ✓ Replace or clean the disc, see “Maintenance”. ✓ Use a finalised CD-RW or correct format disc.
<p>Radio reception is poor.</p>	<ul style="list-style-type: none"> ✓ If the signal is too weak, adjust the antenna or connect an external antenna for better reception. ✓ Increase the distance between the Micro HiFi System and your TV or VCR.
<p>The system does not react when buttons are pressed.</p>	<ul style="list-style-type: none"> ✓ Remove and reconnect the AC power plug and switch on the system again.
<p>Sound cannot be heard or is of poor quality.</p>	<ul style="list-style-type: none"> ✓ Adjust the volume. ✓ Disconnect the headphone.
<p>The remote control does not function properly.</p>	<ul style="list-style-type: none"> ✓ Select the source (CD or TUNER, for example) before pressing the function button (▶ , ◀◀ / ▶▶). ✓ Reduce the distance between the remote control and the system. ✓ Insert the battery with its polarities (+/- signs) aligned as indicated. ✓ Replace the battery. ✓ Point the remote control directly toward IR sensor on the front of the system.
<p>The timer is not working.</p>	<ul style="list-style-type: none"> ✓ Set the clock correctly. ✓ Switch on the timer.
<p>The Clock/Timer setting is erased.</p>	<ul style="list-style-type: none"> ✓ Power has been interrupted or the power cord has been disconnected. Reset the clock/timer.

Troubleshooting

Problem	Solution
Some files on the USB device are not displayed.	✓ Check if the number of folders exceeds 99 or the number of titles exceeds 400.
“DEVICE NOT SUPPORTED” scrolls on the display.	✓ Remove the USB mass storage device or select another source.

English

Français

Español

Philips Consumer Lifestyle
A division of Philips Electronics North America Corporation
P.O. Box 10313
Stamford, CT 06904
Phone: 1-888-PHILIPS (744-5477)

Meet Philips at the Internet
<http://www.philips.com/welcome>

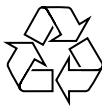

DCM230



© 2010 Koninklijke Philips Electronics N.V.
All rights reserved.

Printed in China

DCM230_37_UM_V2.0