

Register your product and get support at
www.philips.com/welcome

DS9800W



User manual

PHILIPS

Contents

1 Important	4	7 Update firmware	24
Safety	4	Download the update file	24
Notice	5	Update from the configuration page	24
2 Your Entertainment System	7	8 Product information	26
Introduction	7	Specifications	26
What's in the box	7	9 Troubleshooting	27
What else you need	7		
Overview of the wireless			
SoundSphere speakers	8		
Overview of the remote control	8		
Overview of the docking charger	9		
3 Prepare	10		
Connect	10		
Prepare the remote control	11		
4 Connect to your home Wi-Fi network for AirPlay	12		
Scenario 1: Connect to a WPS router	12		
Scenario 2: Connect to a non-WPS router	13		
5 Play	19		
Stream audio from your iTunes music library to DS9800W	19		
Control play	21		
Use advanced sound settings	21		
Play from an external device	21		
6 Charge your iPod/iPhone/iPad through the separate docking charger	22		
Compatible iPod/iPhone/iPad	22		
Load the iPod/iPhone/iPad	22		

1 Important

Safety

Mains fuse

This information applies only to products with a UK mains plug.

This product is fitted with an approved molded plug. If you replace the fuse, use one with:

- the ratings shown on the plug,
- a BS 1362 approval, and
- the ASTA approval mark.

Contact your dealer if you are not sure about what type of fuse to use.

Caution: To conform with the EMC directive (2004/108/EC), do not detach the plug from the power cord.

Information for Europe: Know these safety symbols



The 'exclamation mark' calls attention to features for which you should carefully read the supplied literature to prevent operating and maintenance problems.

The 'lightening bolt' symbol indicates uninsulated components within the product that can cause an electric @shock.

To reduce the risk of fire or electric shock, do not expose the product to rain or moisture and do not place any objects filled with liquids, such as vases, on the product.

- ① Read these instructions.
- ② Keep these instructions.
- ③ Heed all warnings.
- ④ Follow all instructions.
- ⑤ Do not use this product near water.
- ⑥ Clean only with dry cloth.
- ⑦ Do not block any ventilation openings. Install in accordance with the manufacturer's instructions.
- ⑧ Do not remove the casing of this product.
- ⑨ Only use this product indoors. Do not expose the product to dripping / splashing water, rain or high humidity.
- ⑩ Keep this product away from direct sunlight, naked flames or heat.
- ⑪ Do not install near any heat sources such as radiators, heat registers, stoves, or other electrical equipment (including amplifiers).
- ⑫ Do not place any other electrical equipment on the product.
- ⑬ Do not place any sources of danger on the product (e.g. objects containing liquids, burning candles).
- ⑭ This product may include batteries. Please refer to safety and disposal instructions for batteries in this user manual.
- ⑮ Where the mains plug or an appliance coupler is used as the disconnect device, the disconnect device shall remain readily operable.

Warning

- Never remove the casing of this apparatus.
- Never lubricate any part of this apparatus.
- Never place this apparatus on other electrical equipment.
- Keep this apparatus away from direct sunlight, naked flames or heat.
- Ensure that you always have easy access to the power cord, plug or adaptor to disconnect this apparatus from the power.

Risk of overheating! Never install this apparatus in a confined space. Always leave a space of at least four inches around this apparatus for ventilation. Ensure curtains or other objects never cover the ventilation slots on this apparatus.

Mains fuse

This information applies only to products with a UK mains plug.

This product is fitted with an approved molded plug. If you replace the fuse, use one with:

- the ratings shown on the plug,
- a BS 1362 approval, and
- the ASTA approval mark.

Contact your dealer if you are not sure about what type of fuse to use.

Caution: To conform with the EMC directive (2004/108/EC), do not detach the plug from the power cord.

Notice



This product complies with the radio interference requirements of the European Community.

CE 2150  R&TTE Directive 1999/5/EC									
BG ✓	RO ✓	BE ✓	LT ✓	LI ✓	IS ✓	SE ✓			
DK ✓	ES ✓	CZ ✓	NL ✓	AT ✓	LV ✓	SK ✓			
FR ✓	UK ✓	FI ✓	PT ✓	CY ✓	MT ✓	PL ✓			
HU ✓	NO ✓	GR ✓	SI ✓	EE ✓					
IT ✓	LU ✓	IE ✓	CH ✓	DE ✓					

The device can be operated in the EU without restrictions indoor; but cannot be operated outdoors in France in the whole of the band until further notice.

This product complies with the requirement of the 1999/5/EC directive.

Modifications

Modifications not authorized by the manufacturer may void user's authority to operate this product.



Your product is designed and manufactured with high quality materials and components, which can be recycled and reused.



When this crossed-out wheeled bin symbol is attached to a product it means that the product is covered by the European Directive 2002/96/EC.

Please inform yourself about the local separate collection system for electrical and electronic products.

Please act according to your local rules and do not dispose of your old products with your normal household waste. Correct disposal of your old product helps to prevent potential negative consequences for the environment and human health.



Your product contains batteries covered by the European Directive 2006/66/EC, which cannot be disposed with normal household waste. Please inform yourself about the local rules on separate collection of batteries because correct disposal helps to prevent negative consequences for the environmental and human health.

Information about the use of batteries:

Caution

- Risk of leakage: Only use the specified type of batteries. Do not mix new and used batteries. Do not mix different brands of batteries. Observe correct polarity. Remove batteries from products that are not in use for a longer period of time. Store batteries in a dry place.
- Risk of injury: Wear gloves when handling leaking batteries. Keep batteries out of reach of children and pets.
- Risk of explosion: Do not short circuit batteries. Do not expose batteries to excessive heat. Do not throw batteries into the fire. Do not damage or disassemble batteries. Do not recharge non-rechargeable batteries.

Environmental information

All unnecessary packaging has been omitted. We have tried to make the packaging easy to separate into three materials: cardboard (box), polystyrene foam (buffer) and polyethylene (bags, protective foam sheet.) Your system consists of materials which can be recycled and reused if disassembled by a specialized company. Please observe the local regulations regarding the disposal of packaging materials, exhausted batteries and old equipment.



“Made for iPod,” “Made for iPhone,” and “Made for iPad” mean that an electronic accessory has been designed to connect specifically to iPod, iPhone, or iPad, respectively, and has been certified by the developer to meet Apple performance standards. Apple is not responsible for the operation of this device or its compliance with safety and regulatory standards. Please note that the use of this accessory with iPod, iPhone, or iPad may affect wireless performance.

AirPlay, iPod, and iPhone are trademarks of Apple Inc., registered in the U.S. and other countries. iPad is a trademark of Apple Inc.

Class II equipment symbol:



CLASS II apparatus with double insulation, and no protective earth provided.

Note

- The type plate is located on the bottom of the apparatus.

2 Your Entertainment System

Congratulations on your purchase, and welcome to Philips! To fully benefit from the support that Philips offers, register your product at www.philips.com/welcome.

If you contact Philips, you will be asked for the model and serial number of this apparatus. The model number and serial number are on the bottom of the apparatus. Write the numbers here:

Model No. _____

Serial No. _____

Introduction

Apple AirPlay technology enables you to play your iTunes music library, hosted on a Mac, PC, iPhone, iPod touch, or iPad on any AirPlay-enabled device (for example, your DS9800W) connected to the Wi-Fi network.

With an AirPlay-enabled device (for example, your DS9800W), you can:

- stream audio from your iTunes music library to any room in your house
- choose which AirPlay-enabled devices you want to play music on (if you have more than one such devices in your house)
- stream audio to multiple AirPlay-enabled devices at the same time (from the iTunes music library on your PC/Mac only)



Tip

- Please visit www.philips.com/welcome for information about more Philips AirPlay-enabled devices.

With DS9800W, you can also:

- play music from other audio devices through the **MP3-LINK** socket.

With the supplied separate docking charger, you can:

- charge your iPod/iPhone/iPad directly.

What's in the box

Check and identify the contents of your package:

- Main unit (2 x wireless SoundSphere speakers, with a built-in Wi-Fi module)
- 1 x speaker connection cable
- 1 x AC power cord (for the main unit)
- 1 x remote control with battery (for the main unit)
- 1 x MP3 link cable
- 1 x separate docking charger
- 1 x AC power adaptor (for the docking charger)
- User manual (in CD-ROM)
- Quick start guide

What else you need

To stream audio wirelessly by AirPlay, you need:

- A Wi-Fi certified router
- A host for your iTunes music library, for example, an iPod touch/iPhone/iPad installed with iOS 4.3 (or later) or a Wi-Fi enabled PC/Mac installed with iTunes 10 (or later)

Your DS9800W should be connected to the same local network as your iTunes host device through the Wi-Fi router.

List of compatible iTunes host devices for AirPlay

In terms of AirPlay, DS9800W is compatible with:

- a Wi-Fi enabled PC/Mac installed with iTunes 10 (or later); and
- the following iPod/iPhone/iPad models installed with iOS 4.3 (or later):
 - iPad 2
 - iPad
 - iPhone 4
 - iPhone 3GS
 - iPod touch (2nd, 3rd, and 4th generation)



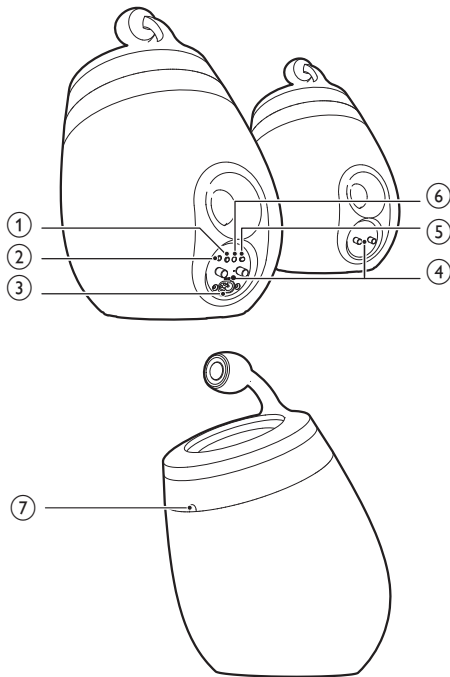



Overview of the wireless SoundSphere speakers

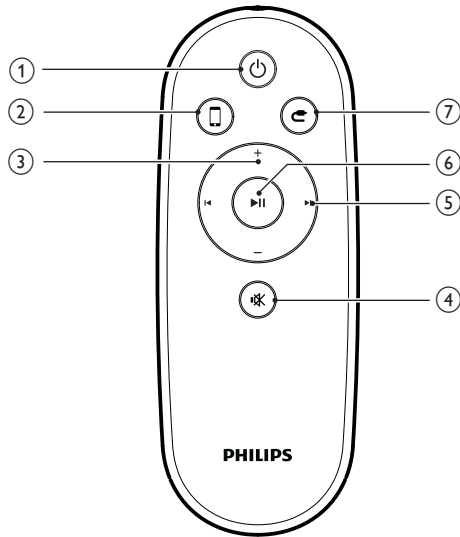

- ① **Power**
 - Turn the unit on/off.
 - (Press and hold) reset the unit.
- ② **MP3-LINK**
 - Connect an external audio player through the supplied MP3 link cable.
- ③ **~ AC IN**
 - Connect the power cord.
- ④ **Speaker connectors (+/-)**
 - Connect the two speakers through the supplied speaker cable.
- ⑤ **WiFi SETUP**
 - Connect the unit to a Wi-Fi network.
- ⑥ **LED indicator**
 - Show the current status of the unit.
- ⑦ **IR sensor**
 - Detect signals from the remote control. Point the remote control directly at the sensor.

Overview of the remote control



- ① 
 - Turn the unit on/off.
- ② 
 - Select the AirPlay device audio source.
- ③ +/-
 - Adjust volume.
- ④ 
 - Mute or restore volume.
- ⑤ 
 - Skip to the previous/next track.
- ⑥ 
 - Start or pause play.
- ⑦ 
 - Select the MP3 link audio source.

Overview of the docking charger

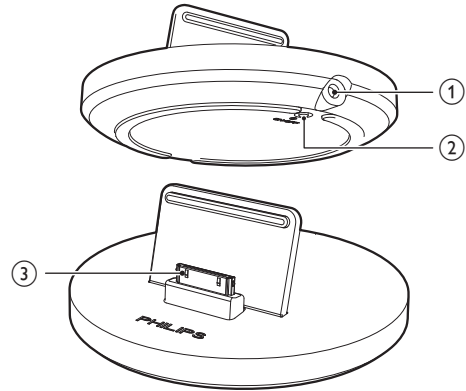

- ① ~ DC IN
 - Connect the power adaptor.
- ② ON/OFF
 - Switch on or off the LED light around the docking charger.
- ③ iPod/iPhone/iPad dock connector

3 Prepare

Always follow the instructions in this chapter in sequence.

Connect

Connect speaker cables

Note

- Insert the stripped portion of each speaker wire into the socket completely.
- For optimal sound, use the supplied speakers only.

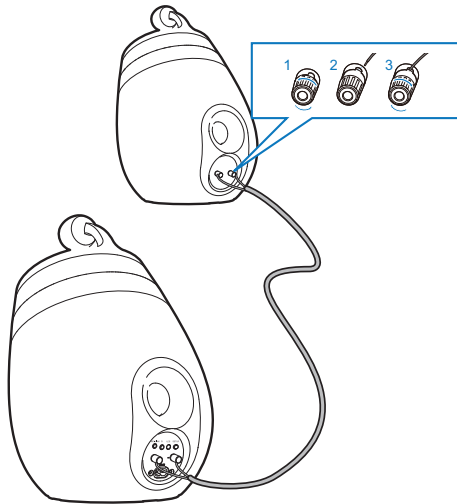

- 1 Unscrew the speaker connectors.
- 2 Insert fully the end of a speaker cable with red mark into the left red (+) connector.
- 3 Screw the left red (+) connector to secure the cable.
- 4 Insert fully the end of a speaker cable without red mark into the left black (-) connector.

- 5 Screw the left black (-) connector to secure the cable.
- 6 Repeat steps 2-5 to insert the other speaker cable into the right connectors.

Connect power

Caution

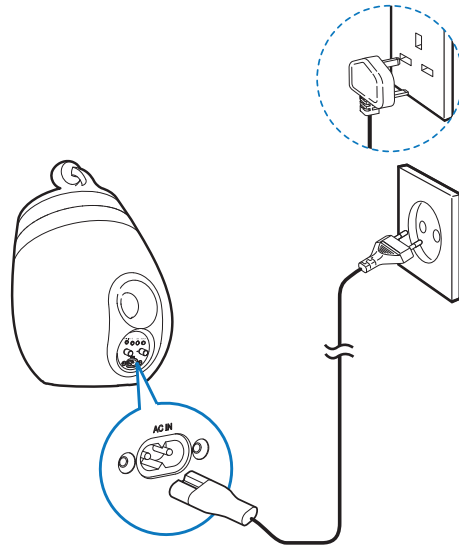

- Risk of product damage! Make sure that the power supply voltage matches the voltage printed on the bottom of the unit.
- Risk of electric shock! When you unplug the AC cord, always pull the plug from the socket. Never pull the cord.
- Before you connect the AC cord, make sure that you have completed all the other connections.



- Connect the AC power cord to
 - the ~ **AC IN** socket on the back of the main speaker.
 - the wall power socket.

Turn DS9800W on

After proper power connection, the unit switches on automatically.

- Wait for successful boot-up of the unit.
 - ↳ The boot-up takes about 35 seconds.
 - ↳ During boot-up, the LED indicator on the back of the unit blinks green quickly.
 - ↳ After boot-up, if no Wi-Fi connection has been set up for DS9800W, the LED indicator starts to blink green slowly.
- To switch the unit to standby mode, press .
- To switch the unit on from standby mode, press .

Prepare the remote control

Caution

- Risk of explosion! Keep batteries away from heat, sunshine or fire. Never discard batteries in fire.

For first-time use:

- 1 Remove the protective tab to activate the remote control battery.

To replace the remote control battery:

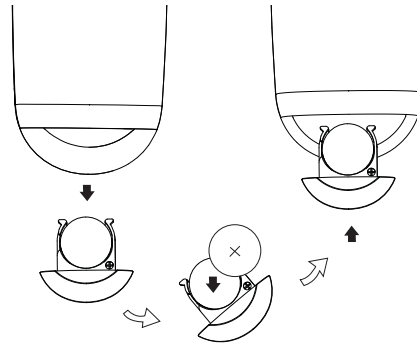

- 1 Open the battery compartment.
- 2 Insert one CR2032 battery with correct polarity (+/-) as indicated.
- 3 Close the battery compartment.

Note

- Before you press any function button on the remote control, first select the correct source with the remote control instead of the main unit.
- If you are not going to use the remote control for a long time, remove the battery.
- Point the remote control directly at the IR sensor on the front of the main speaker for better reception.

4 Connect to your home Wi-Fi network for AirPlay



To connect DS9800W to your existing home Wi-Fi network, you need to apply your home Wi-Fi setting to DS9800W.

You can do this in two ways (depending on which type of Wi-Fi router you use):

- Automatically - if your Wi-Fi router is WPS (Wi-Fi Protected Setup)-enabled and supports PBC (Push Button Connection) (see 'Scenario 1: Connect to a WPS router' on page 12)
- Manually - if your Wi-Fi router does not support WPS (see 'Scenario 2: Connect to a non-WPS router' on page 13)

Once connected successfully, DS9800W will remember your home Wi-Fi settings. Then you can enjoy AirPlay whenever DS9800W is powered on and connected to your home Wi-Fi network automatically.

Before connection of DS9800W to your home Wi-Fi network, check the points below.

- 1 Make sure that your Wi-Fi router is powered on and working properly.
- 2 Make sure that DS9800W has been powered on and booted up successfully (see 'Turn DS9800W on' on page 11).
- 3 Identify the type of your Wi-Fi router (see the user manual of your Wi-Fi router for details).

Scenario 1: Connect to a WPS router

Note

- Before you press any button on DS9800W, make sure that DS9800W has been booted up successfully (see 'Turn DS9800W on' on page 11).

- 1 Press the WPS button on your home Wi-Fi router:



- 2 Shortly after step 1, press **Wi-Fi SETUP** on the back of the main speaker:
 - ↳ The LED indicator blinks red, yellow and green alternately.
 - ↳ Within 2 minutes, the LED indicator stops blinking and stays green, and the unit beeps.
 - ↳ DS9800W is connected to your home Wi-Fi network successfully.



Tip

- For some Wi-Fi routers, you may need to hold the WPS button for Wi-Fi connection or enable the WPS PBC function from the router configuration pages. See the user manuals of the specific routers for details.
- If the LED indicator on DS9800W blinks yellow, it means that the Wi-Fi connection has failed. Please wait for 2 minutes and try again. If the problem remains, try to set up the Wi-Fi connection manually (see 'Scenario 2: Connect to a non-WPS router' on page 13).
- If the Wi-Fi connection fails again, press and hold  on the main speaker to reset it, and then try again.

Scenario 2: Connect to a non-WPS router

Note

- You can also follow the procedures below to connect DS9800W to a WPS router manually.

To connect DS9800W to a Wi-Fi router manually, you need access to DS9800W's built-in configuration web page for change of its internal Wi-Fi settings. To do so, you need a Wi-Fi enabled device with an Internet browser for temporary Wi-Fi connection to DS9800W.

The Wi-Fi enabled device can be an iPod touch/ iPhone/iPad or a Wi-Fi enabled PC/Mac. Follow the sequence below for connection of DS9800W to a non-WPS Wi-Fi router:

- 1 Collect settings of your home Wi-Fi router and write down on paper for use during DS9800W Wi-Fi setup (see 'Collect settings of your home Wi-Fi router' on page 14).
- 2 Switch DS9800W to Assisted Wi-Fi Setup mode (see 'Switch DS9800W to Assisted Wi-Fi Setup mode' on page 14).
 - ↳ A new Wi-Fi network created by DS9800W will appear, with the network name (SSID) of **Philips Fidelio AirPlay**.
- 3 Connect your Wi-Fi enabled device to the created new Wi-Fi network temporarily (see 'Connect your Wi-Fi enabled device to the newly created Wi-Fi network' on page 14).
- 4 Open the built-in web page of DS9800W with the Internet Browser of your Wi-Fi enabled device (see 'Open the built-in web page of DS9800W' on page 16).
- 5 Change the internal Wi-Fi settings of DS9800W based on the settings you wrote on paper at step 1 (see 'Change the internal Wi-Fi settings of DS9800W' on page 17).
- 6 Restore your Wi-Fi enabled device back to your existing home Wi-Fi settings (see 'Restore your Wi-Fi enabled device back to your existing home Wi-Fi setting' on page 18).

Collect settings of your home Wi-Fi router

Note

- Always consult the user manual of your home Wi-Fi router for detailed instructions.

- 1 Connect your Wi-Fi enabled device to your existing home Wi-Fi network.
- 2 Launch the Internet browser (for example, Apple Safari or Microsoft Internet Explorer) on your Wi-Fi enabled device.
- 3 Open the configuration page of your home Wi-Fi router.
- 4 Find the Wi-Fi settings tab and write down the following information on paper:
 - (A) Network name (SSID)
 - (B) Wi-Fi security mode (usually WEP, WPA or WPA2 if enabled)
 - (C) Wi-Fi password (if Wi-Fi security is enabled)
 - (D) DHCP mode (enabled or disabled)
 - (E) Static IP address settings (if DHCP mode is disabled)

Switch DS9800W to Assisted Wi-Fi Setup mode

- After successful boot-up (see 'Turn DS9800W on' on page 11), press and hold **Wi-Fi SETUP** on the back of the main speaker for more than 5 seconds.
 - ↳ The LED indicator blinks green and yellow alternately.
 - ↳ A new Wi-Fi network of DS9800W itself is created, with the network name (SSID) of **Philips Fidelio AirPlay**.
 - ↳ It takes about 45 seconds for successful creation of this new Wi-Fi network.

Note

- After you finish manual Wi-Fi setting for DS9800W, this new Wi-Fi network disappears.
- If you fail to enter Assisted Wi-Fi Setup mode, power off DS9800W and power on it, then try again after successful boot-up.
- Make sure that there are no other Philips AirPlay-enabled devices in Assisted Wi-Fi Setup mode at the same time. Multiple new Wi-Fi networks created this way may interfere with each other.

Connect your Wi-Fi enabled device to the newly created Wi-Fi network

The new Wi-Fi network created by DS9800W only allows access of one Wi-Fi enabled device. To avoid interference from any other Wi-Fi devices, you are recommended to temporarily disable the Wi-Fi function on your other Wi-Fi devices.

Option 1: Use your iPod touch/iPhone/iPad

- 1 Select **Settings** -> **Wi-Fi** on your iPod touch/iPhone/iPad.



- 2 Select **Philips Fidelio AirPlay** from the list of available networks.

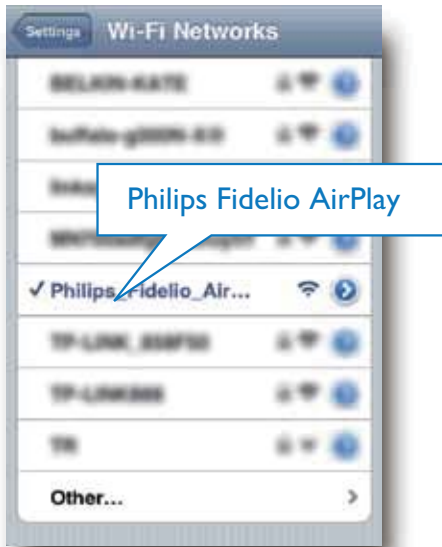

- 3 Wait until successful Wi-Fi connection on your iPod touch/iPhone/iPad.
 ↳  is displayed at the upper left corner of your iPod touch/iPhone/iPad.

 **Tip**

- If **Philips Fidelio AirPlay** is not in the list, try to scan the available Wi-Fi networks again.

Option 2: Use your Wi-Fi enabled PC/Mac

 **Note**

- See the user manual of your PC/Mac for how to connect your PC/Mac to a Wi-Fi network.
- During Wi-Fi network connection, do not connect any network cable to your PC/Mac.

- 1 Open the Wi-Fi setup tool or control panel on your PC/Mac.

- 2 Scan the available Wi-Fi networks.



- 3 Select **Philips Fidelio AirPlay** from the list of available networks.



- 4 Wait until successful Wi-Fi connection on your PC/Mac.



 Tip

- If Philips Fidelio AirPlay is not in the list, try to scan the available Wi-Fi networks again.

Open the built-in web page of DS9800W

- 1 Launch Apple **Safari** browser or any other Internet browser on your Wi-Fi enabled device.
- 2 Type in **192.168.1.1** at the browser address bar and confirm.
↳ The DS9800W configuration web page is displayed.



If you use Safari on your Wi-Fi enabled PC/Mac, you can also select 'Philips_Fidelio XXX' from the Bonjour pull-down list to enter the DS9800W configuration web page directly.

- 1 Click  -> Preferences.
↳ The Bookmarks menu is displayed.



- 2 Tick Include Bonjour for Bookmarks bar.



- 3 Select 'Philips_Fidelio XXX' from the Bonjour pull-down list shown at the bookmarks bar.
↳ The DS9800W configuration web page is displayed.

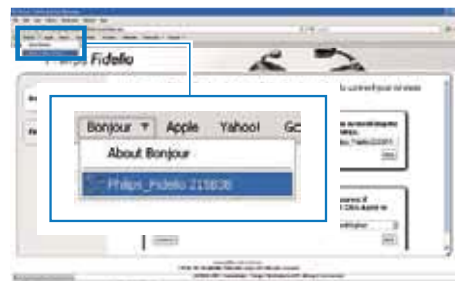

Change the internal Wi-Fi settings of DS9800W

On the DS9800W configuration web page, you can change the internal Wi-Fi settings of DS9800W for connection of DS9800W to your existing home Wi-Fi network.

Note

- Make sure that the settings on the configuration web page match your home Wi-Fi network settings that you wrote on paper.



- Follow the on-screen instructions to change and confirm the internal Wi-Fi settings of DS9800W.
 - ↳ After a while, the indicator on the back of DS9800W stops blinking and stays green, and the unit beeps.
 - ↳ DS9800W is connected to your existing home Wi-Fi network successfully.

Note

- If the LED indicator on DS9800W does not stay green steadily, it means that the Wi-Fi connection has failed. Please power off both your Wi-Fi router and DS9800W and then power on them again to see whether DS9800W can be connected to your home Wi-Fi network. If the problem remains, try the above procedures again.
- After you finish the above changes or power-off and power-on of DS9800W, the new Wi-Fi network created by DS9800W will disappear.

Tip

- If you like, you can change the name of your DS9800W in **Advanced settings -> AirPlay Device Name** on the DS9800W configuration web page. This is helpful when you have multiple Philips AirPlay-enabled devices in your house and you need to distinguish between them.
- If you want to enter the network name (SSID) manually (for example, if you want to hide your SSID), go to **Advanced settings -> CONFIGURE MANUALLY** on the DS9800W configuration web page.

Restore your Wi-Fi enabled device back to your existing home Wi-Fi setting

Note

- Make sure that the settings at steps 2 to 3 below match your home Wi-Fi network settings you wrote on paper.

- 1 Select **Settings** -> **Wi-Fi** on your iPod touch/iPhone/iPad.
 - Or open the list of available Wi-Fi networks on your PC/Mac.



- 2 Select your network name (SSID) from the list of available wireless networks.



- 3 Enter the network key if required.
- 4 Wait until successful Wi-Fi connection to your home Wi-Fi network.

5 Play

Stream audio from your iTunes music library to DS9800W

Note

- Make sure that your iTunes host device is connected to the same Wi-Fi network as DS9800W. Your iTunes device can be an iPod touch/iPhone/iPad installed with iOS 4.3 (or later) or a Wi-Fi enabled PC/Mac installed with iTunes 10 (or later).

Stream from your iPod touch/iPhone/iPad

- 1 Launch the **iPod/Music** application on your iPod touch/iPhone/iPad.
- 2 Tap on the AirPlay icon.

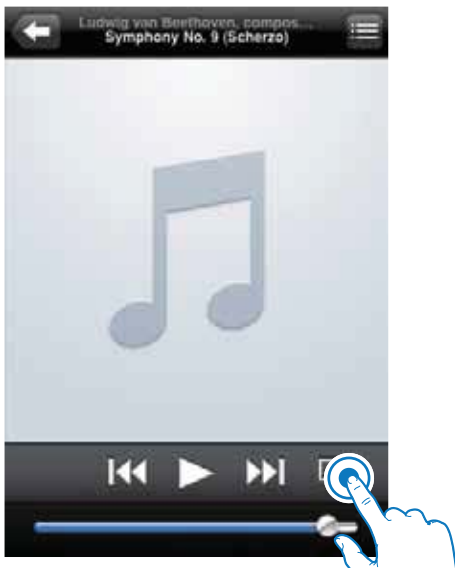

- 3 Select **Philips_Fidelio XXXX** (or user customized name) from the AirPlay list.



- 4 Select a media file and start play.
 - ↳ After a while, you will hear music from DS9800W.

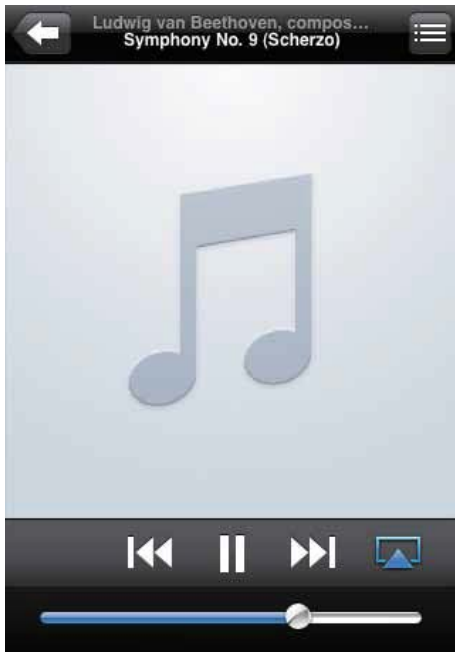

Note

- If you fail to hear music after successful setup, do one of the following on your iPod touch/iPhone/iPad:
 - (1) Disconnect and then re-connect to the same Wi-Fi router again;
 - (2) Close all applications running at the background;
 - (3) Power off and then power on your iPod touch/iPhone/iPad again.

Stream from your PC/Mac

- 1 Launch iTunes 10 (or a later version) on your PC/Mac.
- 2 Click the AirPlay icon on the window.

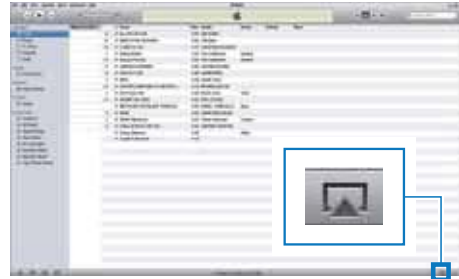

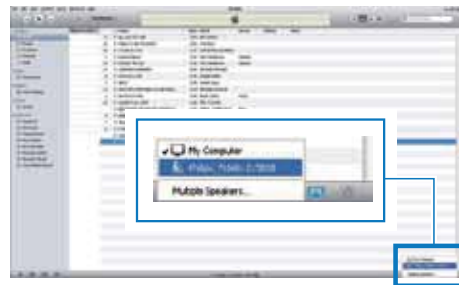

- 3 Select **Philips_Fidelio_AirPlay XXXX** (or user customized name) from the AirPlay list.

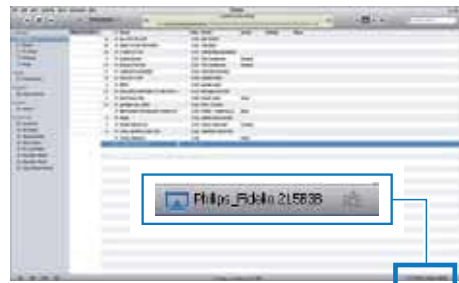

- 4 Select a media file and start play.
 - ↳ After a while, you will hear music from DS9800W.



Tip





- When you stream audio from your iTunes music library on a PC/Mac, you can select more than one AirPlay-enabled devices (if available) at step 3 to stream music to all of them at the same time.
- If you are using an earlier version of iTunes, the AirPlay icon may be  instead of .

Control play

You can select different play options from either your iTunes host device or DS9800W.

Note

- The operations below are based on the supplied remote control of DS9800W.
- Make sure that you have successfully streamed audio from your iTunes music library to DS9800W.

- To start or pause play, press .
- To skip to the previous or next track, press .
- To adjust volume, press +/- repeatedly.
- To mute or restore volume, press .
- To switch to the MP3 link audio source (if connected), press .
- To switch back to the AirPlay audio source, press .

Tip

- If you are streaming music from a PC/Mac, to control music play from AD7000W, launch iTunes and tick **Allow iTunes audio control from remote speakers** in **Edit** (for Windows) or **iTunes** (for Mac) -> **Preferences...** -> **Devices**.

Use advanced sound settings

If your iTunes host device is an iPod touch/ iPhone/iPad:

For advanced sound settings and additional features, you can use your iPod touch/iPhone/iPad to download the **Philips Fidelio** application from Apple App Store. It is a free application from Philips.

If your iTunes host device is a Wi-Fi enabled PC/Mac:

For advanced sound settings, you can use the equalizer available on iTunes directly (**View** -> **Show Equalizer**).

Tip

- See the iTunes help documentation for more details.

Play from an external device

You can also listen to an external audio player through DS9800W.

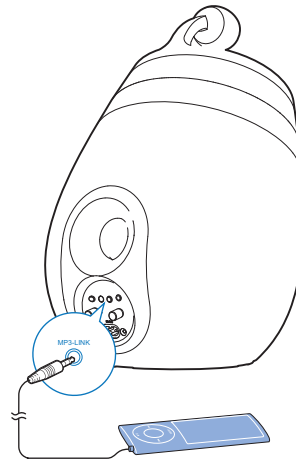

- 1 Connect the supplied MP3 link cable to:
 - the **MP3-LINK** socket on the back of DS9800W.
 - the headphone socket on an external audio player.
- 2 Press  to select the MP3 link source.

6 Charge your iPod/iPhone/iPad through the separate docking charger

You can charge your iPod/iPhone/iPad through the supplied separate docking charger.

Compatible iPod/iPhone/iPad

The separate docking charger supports charge of the following iPod, iPhone, and iPad models.

- iPad 2
- iPad
- iPhone 4
- iPhone 3GS
- iPhone 3G
- iPhone
- iPod classic
- iPod 5G
- iPod 4G
- iPod nano (2nd, 3rd, 4th, 5th, and 6th generation)
- iPod touch (1st, 2nd, 3rd, and 4th generation)

Load the iPod/iPhone/iPad

- 1 Connect the AC power cord to
 - the ~ DC IN socket on the docking charger.
 - the wall power socket.

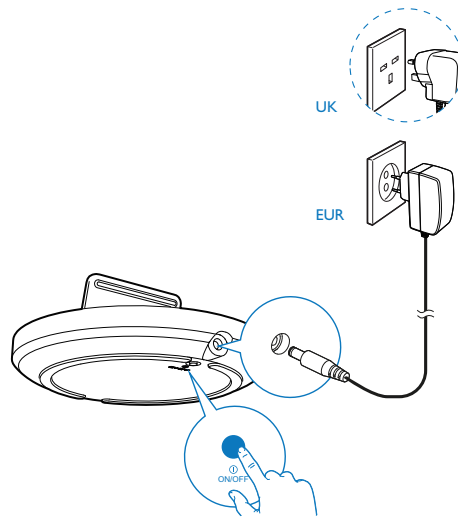

- 2 Place the iPod/iPhone/iPad in the docking charger:
- ↳ The docked iPod/iPhone/iPad begins to charge as soon as the docking charger is connected to AC power.

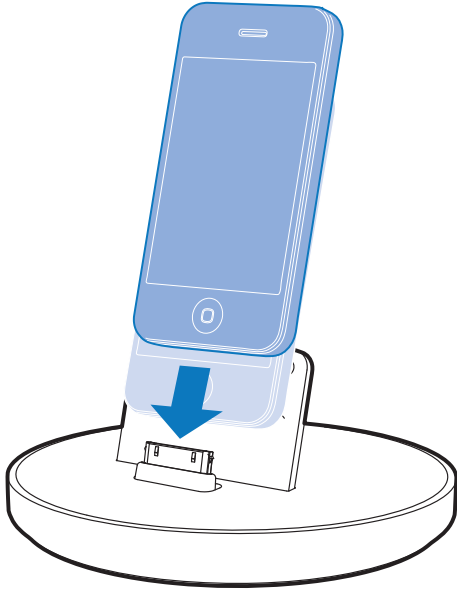

To remove the iPod/iPhone/iPad

- Pull the iPod/iPhone/iPad out of the docking charger.

7 Update firmware

To improve the performance of DS9800W, Philips may offer you new firmware for upgrade of your DS9800W.

Please register your product at www.philips.com/welcome for information about the latest firmware.

Note

- You can only update the firmware from a PC/Mac.

Download the update file

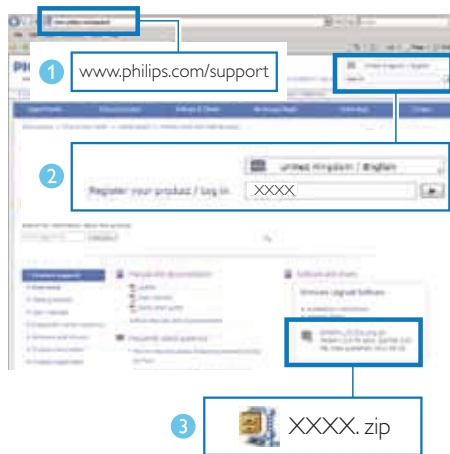

- 1 On your PC/Mac, go to www.philips.com/support.
- 2 Enter the model number to find the latest firmware upgrade file available.
- 3 Save the upgrade file to your hard drive.

Update from the configuration page

Warning

- Always connect your DS9800W to AC power for firmware upgrade. Never power off your DS9800W during firmware upgrade.

Note

- To use an Internet browser other than Apple Safari on your PC/Mac, remember to go to the Wi-Fi router configuration page and write down the IP address of your DS9800W. See the user manual of your Wi-Fi router for how to find the IP addresses of devices connected to the Wi-Fi router.

- 1 Power on DS9800W (see 'Prepare' on page 10).
 - ↳ It takes about 35 seconds for the unit to boot up. During boot-up, the LED indicator on the back of the main speaker blinks green quickly.
 - ↳ After boot-up, you can hear a beep and the LED indicator turns to green steadily. DS9800W is connected to the last configured Wi-Fi network automatically.
- 2 Make sure that DS9800W and your PC/Mac are connected to the same Wi-Fi router.
- 3 Open Apple **Safari** on your PC/Mac, then select 'Philips_Fidelio XXX' from the Bonjour pull-down list.
 - Or open another Internet browser on your PC/Mac, then type in the IP address of DS9800W (available on the Wi-Fi router configuration page) at the address bar.
 - ↳ The DS9800W configuration web page is displayed.

- 4 Select the **Firmware Update** tab, then follow the on-screen instruction to complete the firmware update.

 Note

- In case the firmware update fails, you can try the above procedures again.
- After successful firmware update, if there is any problem with the Wi-Fi connection, press and hold  on DS9800W for more than 5 seconds at the same time to reset the device, and then try to set up the Wi-Fi network for DS9800W again (see 'Connect to your home Wi-Fi network for AirPlay' on page 12).

8 Product information

Note

- Product information is subject to change without prior notice.

Specifications

Amplifier

Rated Output Power	2X50 W RMS
Frequency Response	20 - 20000 Hz, -3dB
Signal to Noise Ratio	> 90 dB
Aux Input (MP3 link)	1 V RMS 20 kohm

Speakers

Speaker Impedance	8 ohm
Speaker Driver	130 mm woofer + 19 mm tweeter
Sensitivity	> 85 dB/m/W

Wireless

Wireless standard	802.11b/g
Wireless security	WEP (64 or 128 bit), WPA/WPA2 (8-63 characters)
Frequency range	2412 - 2462 MHz (CH1-CH11) (for /79, /37, /55, /97) 2412 - 2472 MHz (CH1-CH13) (for /12, /10, /05)
PBC (one button push)	Yes

General information

AC power	Wireless SoundSphere speakers: 100-240V~, 50/60Hz Separate docking charger: Model: ASSA28-050200 Input: 100-240V~50/60Hz 0.45A Output: 5.0V $\overline{\overline{\overline{\quad}}}$ 2000mA
Operation Power Consumption	22 W
Eco Standby Power Consumption	< 0.5 W
Dimensions	- Each speaker 265 in diameter x 410 mm
Weight	- With Packing 14.5 kg - Speakers 12 kg

9 Troubleshooting

Warning

- Never remove the casing of this apparatus.

To keep the warranty valid, never try to repair the system yourself.

If you encounter problems when using this apparatus, check the following points before requesting service. If the problem remains unsolved, go to the Philips web site (www.philips.com/welcome). When you contact Philips, ensure that the apparatus is nearby and the model number and serial number are available.

No power

- Make sure that the AC power plug of the device is connected properly.
- Make sure that there is power at the AC outlet.

No sound

- Adjust the volume.
- Check the network connection. Set up the network again if needed (see 'Connect to your home Wi-Fi network for AirPlay' on page 12).
- Check if you have selected the correct audio source.

No response from the unit

- Press and hold  on DS9800W for more than 5 seconds to reset the device. Then set up the Wi-Fi network for DS9800W again (see 'Connect to your home Wi-Fi network for AirPlay' on page 12).
- Disconnect and reconnect the AC power plug, and then switch on the device again.

Remote control does not work

- Before you press any function button, first select the correct source with the remote control instead of the main unit.

- Reduce the distance between the remote control and the unit.
- Insert the battery with its polarities (+/- signs) aligned as indicated.
- Replace the battery.
- Aim the remote control directly at the IR sensor on the front of the main speaker.

Wi-Fi network connection failed

- Check if your Wi-Fi router is Wi-Fi 802.11b/g certified. This device is only compatible with Wi-Fi 802.11b/g certified routers.
- If your Wi-Fi router is Wi-Fi 802.11n certified, make sure to enable the 802.11b/g mode. DS9800W does not support connection to routers with 802.11n only.
- This device does not support the WPS-PIN method.
- If your Wi-Fi router supports WPS and the WPS-PBC method but fails to connect to DS9800W, try the manual Wi-Fi setup method (see 'Scenario 2: Connect to a non-WPS router' on page 13).
- Enable SSID broadcast on the Wi-Fi router.
- Keep away from potential sources of interference which may affect Wi-Fi signal, such as microwave ovens.
- If you fail to use your PC for Wi-Fi network setup, check whether your PC is using a Wi-Fi network. You cannot use Ethernet connection for AirPlay network setup.
- Make sure that the SSID name of your home router consists of alphanumeric characters, with no space or special characters like %/#/* inserted.
- If you choose to rename the AirPlay device 'Philips_Fidelio XXXX' in the setting menu, do not use special characters or symbols.
- For some new types of Wi-Fi routers, a network name (SSID) may be created automatically when you use WPS for connection. Always change the default network name (SSID) to a simple one that consists of alphanumeric characters, and also change the Wi-Fi security mode to secure your network.

Occasional breaking of AirPlay music streaming

Do one or all of the following:

- Move DS9800W closer to your Wi-Fi router.
- Remove any obstacles between DS9800W and your Wi-Fi router.
- Avoid using Wi-Fi channel which is overlapped by the nearby Wi-Fi network.
- Check if your network speed is fast enough (in cases where multiple devices share the same router, the AirPlay performance may be affected). Turn off the other devices connected to your home router.
- Enable the Quality of Service (QoS) option (if available on the Wi-Fi router).
- Turn off other Wi-Fi routers.

No AirPlay icon on my iTunes host device

- Make sure that DS9800W is already connected to your home Wi-Fi network.
- Before you open iTunes, make sure that you have enabled Bonjour service in your PC. Take Windows XP for example: to enable the service, you can click **Start->Control Panel**, and double-click **Administrative Tools-> Services->Bonjour Service**, then click **Start** followed by **OK** on the pop-up menu.
- If the problem remains, try to restart DS9800W.

AirPlay connection failed with Mac or PC

- Temporarily disable the firewall and security software to see whether it blocks the ports that AirPlay uses to stream content. See the help documentation of your firewall and security software on how to unblock the ports used by AirPlay.
- When you use iPod Touch/iPhone/iPad/Mac/PC for AirPlay, if the music play breaks or stops, try to restart your iPod Touch/iPhone/iPad, iTunes or DS9800W.
- Video streaming or FTP downloads may overload your router and therefore may cause interruptions during AirPlay music play. Try to reduce the load of your router.



Specifications are subject to change without notice
© 2011 Koninklijke Philips Electronics N.V.
All rights reserved.

DS9800W_10_UM_V1.0

