

# Always there to help you

Register your product and get support at  
[www.philips.com/support](http://www.philips.com/support)

DTD3190



## User manual

# PHILIPS



# Contents

<b>1 Important</b>	2
Safety	2
<b>2 Your DVD Micro Theater</b>	4
Introduction	4
What's in the box	4
Overview of the main unit	5
Overview of the remote control	6
<b>3 Connect</b>	7
Place the unit	7
Connect speakers	7
Connect video options	8
Connect power	9
<b>4 Get started</b>	10
Prepare the remote control	10
Set clock	10
Turn on	10
Find the correct viewing channel	11
Select the correct TV system	11
Change system menu language	11
Set up EasyLink (HDMI-CEC control)	11
<b>5 Play</b>	13
Play from disc	13
Play from USB or recorded discs	14
Control play	15
Select tracks	15
Play options	15
<b>6 Enjoy karaoke</b>	16
Adjust Karaoke settings	16
<b>7 Play from Bluetooth-enabled devices</b>	17
<b>8 Play iPod/iPhone/iPad</b>	18
Compatible iPod/iPhone/iPad	18
Load the iPod/iPhone/iPad	18
Play audio from the iPod/iPhone/iPad	18
Charge the iPod/iPhone/iPad	18
Remove the iPod/iPhone/iPad	18
<b>9 Listen to the radio</b>	19
Tune to a radio station	19
Program radio stations automatically	19
Program radio stations manually	19
Select a preset radio station	19
Show RDS information	20
<b>10 Listen to an external device</b>	20
<b>11 Other features</b>	21
Set the alarm timer	21
Set the sleep timer	21
<b>12 Adjust settings</b>	22
General setup	22
Video setup	22
Audio setup	22
Preferences	23
<b>13 Product information</b>	24
Specifications	24
Supported disc formats	25
USB playability information	25
RDS program types	25
<b>14 Troubleshooting</b>	26
<b>15 Notice</b>	28

# 1 Important

## Safety



This 'bolt of lightning' indicates uninsulated material within the device may cause an electrical shock. For the safety of everyone in your household, please do not remove the covering.

The 'exclamation mark' calls attention to features for which you should read the enclosed literature closely to prevent operating and maintenance problems.

**WARNING:** To reduce the risk of fire or electric shock, the device should not be exposed to rain or moisture and objects filled with liquids, such as vases, should not be placed on the device.

**CAUTION:** To prevent electric shock, fully insert the plug. (For regions with polarized plugs: To prevent electric shock, match wide blade to wide slot.)

## Important Safety Instructions

- Follow all instructions.
- Heed all warnings.
- Do not use this device near water.
- Clean only with dry cloth.
- Do not block any ventilation openings. Install in accordance with the manufacturer's instructions.
- Do not install near any heat sources such as radiators, heat registers, stoves, or other devices (including amplifiers) that produce heat.

- Protect the power cord from being walked on or pinched, particularly at plugs, convenience receptacles, and the point where they exit from the device.
- Only use attachments/accessories specified by the manufacturer.
- Use only with the cart, stand, tripod, bracket, or table specified by the manufacturer or sold with the device. When a cart is used, use caution when moving the cart/device combination to avoid injury from tip-over.



- Unplug this device during lightning storms or when unused for long periods of time.
- Refer all servicing to qualified service personnel. Servicing is required when the device has been damaged in any way, such as power-supply cord or plug is damaged, liquid has been spilled or objects have fallen into the device, the device has been exposed to rain or moisture, does not operate normally, or has been dropped.
- Battery usage **CAUTION** – To prevent battery leakage which may result in bodily injury, property damage, or damage to the unit:
  - Install all batteries correctly, + and - as marked on the unit.
  - Do not mix batteries (old and new or carbon and alkaline, etc.).
  - Batteries (packed or installed) shall not be exposed to excessive heat such as sunshine, fire or the like.
  - Remove batteries when the unit is not used for a long time.
- The device shall not be exposed to dripping or splashing.
- Do not place any sources of danger on the device (e.g. liquid filled objects, lighted candles).

- Where the MAINS plug or an appliance coupler is used as the disconnect device, the disconnect device shall remain readily operable.

### Warning

- Never remove the casing of this device.
- Never lubricate any part of this device.
- Never place this device on other electrical equipment.
- Keep this device away from direct sunlight, naked flames or heat.
- Never look into the laser beam inside this device.
- Ensure that you always have easy access to the power cord, plug, or adaptor to disconnect this device from the power.

## Hearing safety



### Caution

- To prevent possible hearing damage, do not listen at high volume levels for long periods.

### Listen at a moderate volume:

- Using headphones at a high volume can impair your hearing. This product can produce sounds in decibel ranges that may cause hearing loss for a normal person, even for exposure less than a minute. The higher decibel ranges are offered for those that may have already experienced some hearing loss.
- Sound can be deceiving. Over time your hearing 'comfort level' adapts to higher volumes of sound. So after prolonged listening, what sounds 'normal' can actually be loud and harmful to your hearing. To guard against this, set your volume to a safe level before your hearing adapts and leave it there.

### To establish a safe volume level:

- Set your volume control at a low setting.
- Slowly increase the sound until you can hear it comfortably and clearly, without distortion.

### Listen for reasonable periods of time:

- Prolonged exposure to sound, even at normally 'safe' levels, can also cause hearing loss.
- Be sure to use your equipment reasonably and take appropriate breaks.

### Be sure to observe the following guidelines when using your headphones.

- Listen at reasonable volumes for reasonable periods of time.
- Be careful not to adjust the volume as your hearing adapts.
- Do not turn up the volume so high that you can't hear what's around you.
- You should use caution or temporarily discontinue use in potentially hazardous situations.
- Do not use headphones while operating a motorized vehicle, cycling, skateboarding, etc.; it may create a traffic hazard and is illegal in many areas.

## 2 Your DVD Micro Theater

Congratulations on your purchase, and welcome to Philips! To fully benefit from the support that Philips offers, register your product at [www.philips.com/welcome](http://www.philips.com/welcome).

### Introduction

With this unit, you can:

- watch video from DVD/VCD/SVCD or USB storage devices.
- enjoy audio from discs, iPod/iPhone/iPad, USB storage devices, or other external devices.
- view pictures from discs or USB storage devices.
- enjoy Karaoke by connecting a microphone.
- listen to FM radio stations.

You can enrich sound output with these sound effects:

- Digital Sound Control (DSC)
  - DSC 1: Balanced
  - DSC 2: Clear
  - DSC 3: Powerful
  - DSC 4: Warm
  - DSC 5: Bright

The unit supports these media/disc formats:



You can play DVD discs marked with the following region code:

DVD region code	Countries
 	Asia Pacific

### What's in the box

Check and identify the contents of your package:

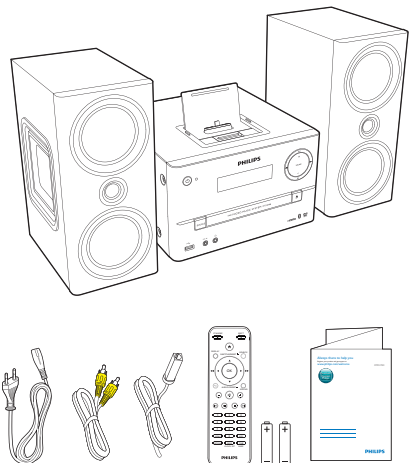

## Overview of the main unit

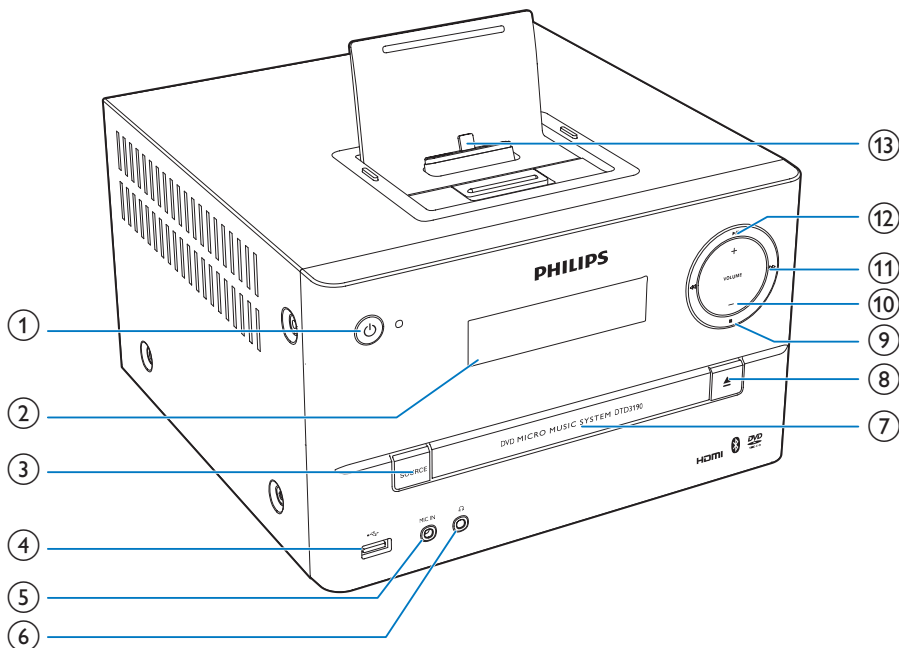

① **⏻ (power button/indicator and Bluetooth indicator)**

- Turn the unit on or off.
- Switch to standby mode or Eco standby mode.
- Indicate the power/Bluetooth connection status.

② **Display panel**

- Show current status.

③ **SOURCE**

- Select a source: BT (Bluetooth), DISC, USB, FM, AUX.

④ **USB**

- Socket for a USB mass storage device.

⑤ **MIC IN**

- Connect a microphone.

⑥ **🎧**

- Headphone socket.

⑦ **Disc compartment**

⑧ **▲**

- Open/close the disc compartment.

⑨ **■**

- Stop play.

⑩ **VOLUME+/-**

- Adjust volume.

⑪ **⏮ / ⏭**

- Skip to the previous/next track.
- Press to tune to a radio station.
- Press and hold to search for radio stations automatically.

⑫ **▶ ||**

- Start, pause, or resume play.

⑬ **DOCK**

- Dock for iPod/iPhone/iPad.

## Overview of the remote control

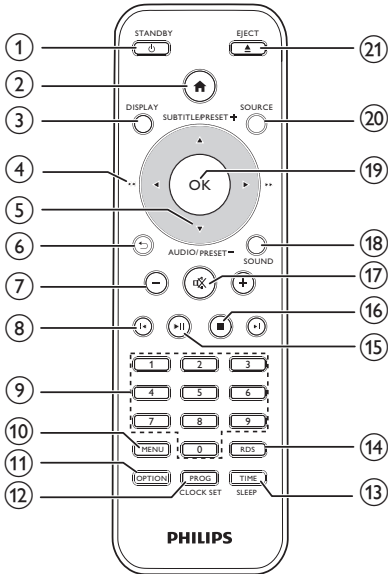

### ① **⏻/STANDBY**

- Turn the unit on or off.
- Switch to standby mode or Eco standby mode.

### ② **🏠**

- Access the system menu.

### ③ **DISPLAY**

- View playback information.

### ④ **◀/▶ (◀◀/▶▶)**

- Navigate through the menu.
- Search within a track/disc/USB.
- Tune to a radio station.

### ⑤ **SUBTITLE/PRESET + (▲) / AUDIO/PRESET - (▼)**

- Navigate through the menu.
- Skip to the previous/next album.
- **SUBTITLE (▲)**: Select a preset radio station.
- **AUDIO (▼)**: Set the subtitle language.
- Set time.

### ⑥ **↶**

- Return to the previous display menu.

### ⑦ **+/-**

- Adjust volume.

### ⑧ **◀ / ▶**

- Skip to the previous or next title, chapter, track, or file.

### ⑨ **Numeric buttons**

- Select a title/chapter/track to play (See **Select tracks** in **Chapter 5** for more details).
- Select a preset number.

### ⑩ **MENU**

- Access DISC/USB/iPod/iPhone/iPad menu.

### ⑪ **OPTION**

- In DISC/USB play mode, press to select preferred play options.

### ⑫ **PROG/CLOCK SET**

- Program radio stations.
- Set the clock.
- View clock information.

### ⑬ **TIME/SLEEP**

- Set the alarm timer.
- Set the sleep timer.

### ⑭ **RDS**

- For selected FM radio stations, display information of Radio Data System (RDS).

### ⑮ **▶▶**

- Start, pause, or resume play.

### ⑯ **■**

- Stop play.

### ⑰ **🔇**

- Mute or restore volume.

### ⑱ **SOUND**

- Enrich sound effect with Digital Sound Control (DSC).

### ⑲ **OK**

- Confirm a selection.



- ⑳ SOURCE
- Select a source: dock, BT (Bluetooth), DISC, USB, FM, AUX.

- ㉑ EJECT ▲
- Press to open or close the disc compartment.

## 3 Connect

### Place the unit

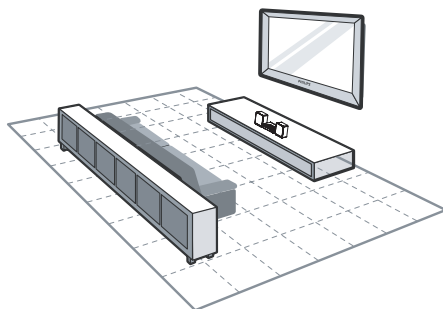

- 1 Place the unit near the TV.
- 2 Place the left and right speakers at equal distance from the TV and at an angle of approximately 45 degrees from the listening position.

#### Note

- To avoid magnetic interference or unwanted noise, never place this apparatus and speakers too close to any radiation devices.
- Place this unit on top of a table.
- Never place this unit in an enclosed cabinet.
- Install this unit near the AC outlet where the AC power plug can be easily reached.

### Connect speakers

#### Note

- For optimal sound, use the supplied speakers only.
- Connect only speakers with impedance that is the same or higher than the supplied speakers. Refer to the Specifications section of this manual.

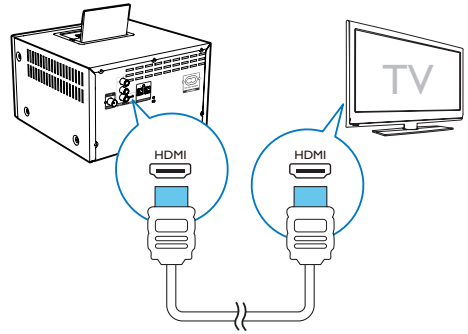
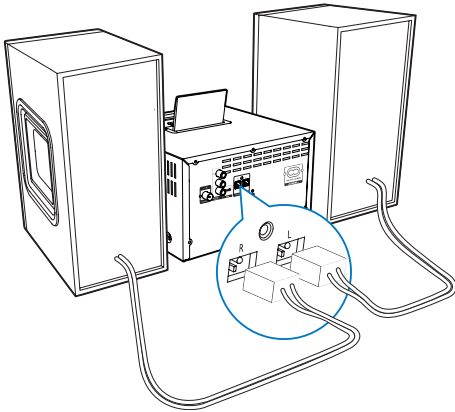

## Connect video options

Select the best video connection that the TV can support.

- **Option 1:** Connect to TV through HDMI-ARC (for an HDMI, DVI or HDCP-compliant TV).
- **Option 2:** Connect to TV through standard HDMI (for an HDMI, DVI or HDCP-compliant TV).
- **Option 3:** Connect to the composite video jack (for a standard TV).

### Option 1: Connect to TV through HDMI (ARC)

#### Best quality video

Your home theater supports HDMI version with Audio Return Channel (ARC). If your TV is HDMI ARC compliant, you can hear the TV audio through your home theater by using a single HDMI cable.

- 1 Using a High Speed HDMI cable (not supplied), connect the **HDMI** connector on your device to the **HDMI ARC** connector on the TV.
  - The **HDMI ARC** connector on the TV might be labeled differently. For details, see the TV user manual.
- 2 On your TV, turn on HDMI-CEC operations. For details, see the TV user manual.
  - HDMI-CEC is a feature that enables CEC compliant devices that are connected through HDMI controlled by a single remote control, such as volume control for both the TV and the home theater.
- 3 If you cannot hear the TV audio through your device, set up the audio manually.

### Option 2: Connect to TV through standard HDMI

#### Best quality video

If your TV is not HDMI ARC compliant, connect your home theater to the TV through a standard HDMI connection.

- 1 Using a High Speed HDMI cable (not supplied), connect the **HDMI** connector on your home theater to the **HDMI** connector on the TV.
- 2 Connect an audio cable to hear the TV audio through your home theater.

- 3 On your TV, turn on HDMI-CEC operations. For details, see the TV user manual.
  - HDMI-CEC is a feature that enables CEC compliant devices that are connected through HDMI controlled by a single remote control, such as volume control for both the TV and the home theater.
- 4 If you cannot hear the TV audio through your home theater; set up the audio manually.

### Note

- If your TV has a DVI connector, you can use an HDMI/DVI adapter to connect to TV. However, some of the features may not be available.

## Option 3: Connect to the TV through composite video

### Basic quality video

If your TV does not have HDMI connectors, use a composite video connection. A composite connection does not support high-definition video.

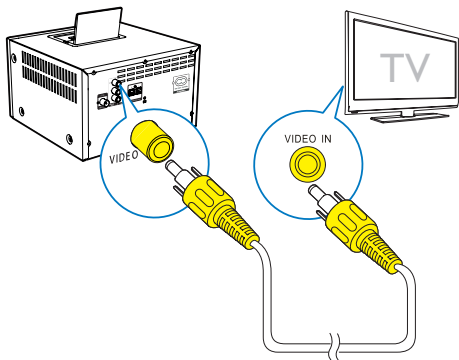

- 1 Using a composite video cable, connect the **VIDEO (VIDEO OUT)** connector on your home theater to the **VIDEO IN** connector on the TV.
  - The composite video connector might be labeled **AV IN**, **COMPOSITE**, or **BASEBAND**.

- 2 Connect an audio cable to hear the TV audio through your home theater.
- 3 While you watch TV programs, press **SOURCE** on your home theater repeatedly to select the correct audio input.
- 4 While you watch TV videos, switch your TV to the correct video input. For details, see the TV user manual.

## Connect power

### Caution

- Risk of product damage! Ensure that the power supply voltage corresponds to the voltage printed on the back or the underside of the unit.
- Risk of electric shock! When you unplug the AC power cord, always pull the plug from the socket. Never pull the cord.
- Before you connect the AC power cord, ensure that you have completed all other connections.

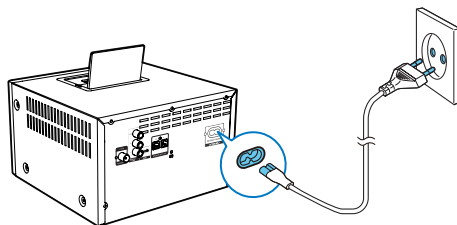

## 4 Get started

### ! Caution

- Use of controls or adjustments or performance of procedures other than herein may result in hazardous radiation exposure or other unsafe operation.

Always follow the instructions in this chapter in sequence.

If you contact Philips, you will be asked for the model and serial number of this apparatus. The model number and serial number are on the back of the apparatus. Write the numbers here:

Model No. \_\_\_\_\_

Serial No. \_\_\_\_\_

## Prepare the remote control

### ! Caution

- Risk of explosion! Keep batteries away from heat, sunshine or fire. Never discard batteries in fire.
- Risk of decreased battery life! Never mix different brands or types of batteries.
- Risk of product damage! When the remote control is not used for long periods, remove the batteries.

To insert the remote control battery:

- 1 Open the battery compartment.
- 2 Insert the supplied AAA batteries with correct polarity (+/-) as indicated.
- 3 Close the battery compartment.

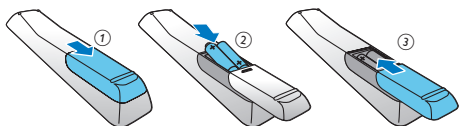

## Set clock

- 1 In standby mode, press and hold **CLOCK SET** on the remote control for more than two seconds.  
↳ [24H] or [12H] hour format is displayed.
- 2 Press **▲ / ▼** (or **+/-**) to select [24H] or [12H] hour format.
- 3 Press **CLOCK SET** to confirm.  
↳ The hour digits are displayed and begin to blink.
- 4 Repeat steps 2-3 to set hour and minute.

### ≡ Note

- If no button is pressed in 90 seconds, the system exits clock setting mode automatically.

### ✱ Tip

- You can view clock information in Eco power mode by pressing **CLOCK SET**.

## Turn on

- Press **⏻**.
- ↳ The unit switches to the last selected source.

## Switch to standby mode

Press **⏻** again to switch the unit to standby mode.

- ↳ The clock (if set) is displayed on the panel.

**Switch to ECO standby mode:**

Press and hold **⏻** for more than two seconds.

- ↳ The display panel is dimmed.

**Note**

- The unit switches to Eco Power Standby mode after 15 minutes in standby mode.

**Switch between standby mode and ECO standby mode:**

Press and hold for more than two seconds.

## Find the correct viewing channel

- 1 Press **SOURCE** repeatedly to select the **DISC** source.
- 2 Turn on the TV and switch to the correct video-in channel in one of the following ways:
  - Go to the lowest channel on your TV, and then press the Channel Down button until you see the blue screen.
  - Press the source button repeatedly on the remote control of your TV.

**Tip**

- The video-in channel is between the lowest and highest channels and may be called FRONT, A/V IN, VIDEO etc. See the TV user manual on how to select the correct input on the TV.

## Select the correct TV system

Change this setting if the video is not displayed correctly. By default, this setting matches the most common setting for TVs in your country.

- 1 Press .
- 2 Select **[Setup]** -> **[Video]** -> **[TV System]**.
- 3 Select a setting and press **OK**.
  - **[PAL]**- For TV with PAL color system.
  - **[Multi]**- For TV that is compatible with both PAL and NTSC.
  - **[NTSC]**- For TV with NTSC color system.

- 4 To return to the previous menu, press .
- 5 To exit the menu, press .

## Change system menu language

- 1 Press .
- 2 Select **[Setup]** -> **[General]** -> **[OSD Language]**, and press **OK**.
- 3 Select a setting and then press **OK**.
- 4 To exit the menu, press .

## Set up EasyLink (HDMI-CEC control)

This home theater supports Philips EasyLink, which uses the HDMI-CEC (Consumer Electronics Control) protocol. EasyLink-compliant devices that are connected through HDMI can be controlled by a single remote control.

**Note**

- Depending on the manufacturer, HDMI-CEC is known by many names. For information about your device, see the user manual of the device.
- Philips does not guarantee 100% interoperability with all HDMI-CEC devices.

**Before you start**

- Connect your product to the HDMI-CEC compliant device through HDMI connection.
- Make the necessary connections described in the quick start guide, and then switch the TV to the correct source for your home theater.

---

## Enable EasyLink

- 1 Press **⬆** (**Home**).
- 2 Select **[Setup]**, and then press **OK**.
- 3 Select **[Video]**, and then press **OK**.
- 4 Select **[HDMI Setup]** > **[EasyLink Setup]** > **[EasyLink]** > **[On]**.
- 5 On your TV and other connected devices, turn on HDMI-CEC control. For details, see the user manual of the TV or other devices.
  - On your TV, set the audio output to 'Amplifier' (instead of TV speakers). For details, see the TV user manual.

---

## EasyLink controls

With EasyLink, you can control your home theater, TV, and other connected HDMI-CEC compliant devices with a single remote control.

- **[One Touch Play]** (One-touch play): If one-touch play is enabled, press **⏻** (**Standby-On**) on the remote control of your home theater to wake up the TV from standby.
- **[One Touch Standby]** (One-touch standby): If one-touch standby is enabled, your home theater can switch to standby with the remote control of the TV or other HDMI-CEC devices.
- **[Sys Audio Control]** (System audio control): If system audio control is enabled, the audio of the connected device is output through your home theater speakers automatically when you play the device.
- **[Audio Mapping]** (Audio input mapping): If system audio control does not work, map the connected device to the correct audio input connector on your home theater.

### Note

- To change the EasyLink control settings, press **⬆** (**Home**), select **[Setup]** > **[Video]** > **[HDMI Setup]** > **[EasyLink Setup]** > **[EasyLink]**.

---

## Set up the audio

If you cannot hear the audio output of a connected device through your home theater speakers, do the following:

- check if you have enabled EasyLink on all the devices, and
  - on your TV, set the audio output to "Amplifier" (instead of TV speakers). For details, see the TV user manual, and
  - setup the EasyLink audio control.
- 1 Press **⬆** (**Home**).
  - 2 Select **[Setup]**, and then press **OK**.
  - 3 Select **[Video]**, and then press **OK**.
  - 4 Select **[HDMI Setup]** > **[EasyLink Setup]** > **[Sys Audio Control]** > **[On]**.
    - To play the audio from the TV speakers, select **[Off]**, and skip the following steps.
  - 5 Select **[HDMI Setup]** > **[EasyLink Setup]** > **[Audio Mapping]**.
  - 6 Follow the onscreen instructions to map the connected device to the audio inputs on your home theater.
    - If you connect your home theater to the TV through an **HDMI ARC** connection, make sure that the TV audio is mapped to the ARC input on your home theater.

# 5 Play

## Play from disc

### ! Caution

- Risk of product damage! Never play discs with accessories such as disc stabilizer rings or disc treatment sheets.
- Never put any objects other than discs into the disc compartment.

- 1 Press **SOURCE** repeatedly to select the **DISC** source.
- 2 Press **▲** to open the disc compartment.
- 3 Insert a disc with the printed side facing upward.
- 4 Press **▲** to close the disc compartment.  
↳ Play starts automatically.

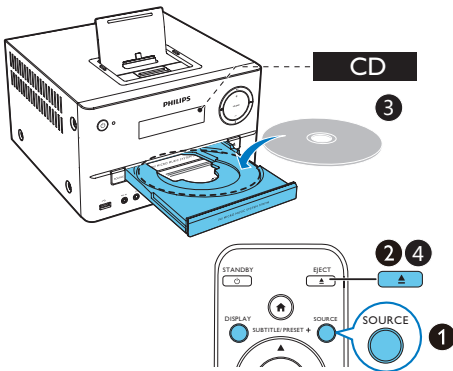

**If play does not start automatically:**  
Select a title/chapter/track and then press **▶||**.

### \* Tip

- To play a locked DVD, enter the 6-digit parental control password.

## Use the disc menu

When you load a DVD/(S)VCD disc, a menu may be displayed on the TV screen. Press **MENU** to access or exit disc menu manually.

### For VCD with PlayBack Control (PBC) feature (version 2.0 only):

With the PBC feature, you can play VCD interactively according to the menu screen. During play, press **MENU** to enable/disable PBC.

- ↳ When PBC is enabled, the menu screen is displayed.
- ↳ When PBC is disabled, normal play is resumed.

## Select an audio language

During disc play, press **AUDIO (▼)** to select an audio language for a DVD or DivX (Home Theater 3.1) video.

- ↳ The language options are displayed. If the selected audio channel is unavailable, the default disc audio channel is used.

### ≡ Note

- For some DVDs, the language can only be changed from the disc menu. Press **MENU** to access the menu.

## Select a subtitle language

During play, press **SUBTITLE (▲)** repeatedly to select a subtitle language for a DVD or DivX (Home Theater 3.1) video.

### ≡ Note

- For some DVDs, the language can only be changed from the disc menu. Press **MENU** to access the disc menu.

## Resume video play from last stopped point

### Note

- This feature is only available for CD/DVD/VCD/DivX play.

In stop mode and when the disc has not been removed, press **▶||**.

### To cancel resume mode and stop play completely:

In stop mode, press **■**.

## Change the audio channel

### Note

- This feature is only available for VCDs and DivX (Home Theater 3.1) videos.

During play, press **AUDIO** repeatedly to select an audio channel available on the disc:

- **[Mono Left]**
- **[Mono Right]**
- **[Mix-Mono]**
- **[Stereo]**

## Play from USB or recored discs

You can play DivX (Home Theater 3.1)/MP3/JPEG picture files copied onto a CD-R/RW, recordable DVD, or USB storage device (Cable USB device is not applicable for this unit).

- 1 Press **SOURCE** repeatedly to select the disc or USB source.
- 2 Insert a disc or a USB storage device.  
↳ Play starts automatically.

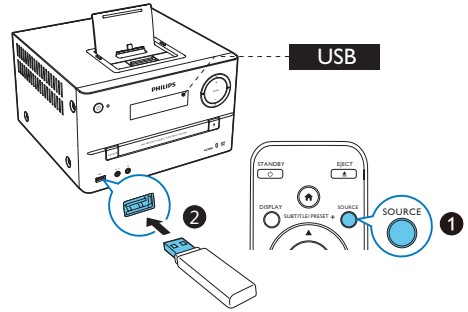

### To play a specified file:

- 1 Press **■** to stop play.
- 2 Press **▲/▼** to select a folder, and then press **OK** to confirm.
  - To return to the previous menu, press **←**.
- 3 Press **▲/▼** to select a file from the folder.
- 4 Press **▶||** to start play.

### Note

- You can only play DivX (Home Theater 3.1) videos rented or purchased through the DivX registration code of this unit.
- Subtitle files with the following filename extensions (.srt, .smi, .sub, .ssa, .ass) are supported but do not appear on the file navigation menu.
- The subtitle filename has to be the same as the file name of the video.

## Play a slideshow with background music

This device can play MP3 files and JPEG photos simultaneously.

### Note

- The MP3 and JPEG files must be stored on the same disc or USB storage device.

- 1 Play an MP3 file.



- 2 Navigate to the photo folder/album and press **▶||** to start the slideshow.
  - ↳ Slideshow begins and continues till the end of the photo folder or album.
  - ↳ Audio continues till the end of the last file.
- To return to the previous menu, press **↶**.
- To stop the slideshow, press **■**.

## Control play

<b>▲ / ▼</b>	Select a folder;
<b>◀ / ▶</b> ( <b>◀◀ / ▶▶</b> )	Fast backward/forward.
<b>◀ / ▶</b>	Skip to the previous or next title/ chapter/track/file.
<b>▶  </b>	Pause or resume play.
<b>■</b>	Stop play.
<b>+/-</b>	Increase or decrease volume.
<b>🔇</b>	Mute or restore sound.
<b>SOUND</b>	Enrich sound effect with DSC: balanced, clear, powerful, warm, and bright.
<b>DISPLAY</b>	View playback information.

## Select tracks

- 1 Press one of any numeric buttons to activate the track select.
  - ↳ The total track numbers display on the screen.
- 2 Press three numeric buttons sequentially to select a track (Total track numbers < 999), or press four numeric buttons sequentially to select a track (Total track numbers > = 1000)  
For example: Press 001 to select track 1, or press 0002 to select track 2.
- 3 Press **OK** to confirm.

## Play options

In **DISC/USB** play mode, press **OPTION** to select different play options.

- **[PBC]**: turn PlayBack Control on/off.
- **[Aspect Ratio]**: select a picture display format to fit the TV screen.
- **[Angle]**: switch between camera angles.



### Note

- Some DVDs contain alternate scenes, such as scenes recorded from different camera angles. For such DVDs, you can select from the available alternate scenes.
- **[Microphone]**: turn on or off the microphone sound output.
- **[Karaoke Setup]**: increase or decrease the volume level and echo level of microphone input, and the key level of music.
- **[Vocal]**: select various Karaoke audio modes, or turn off the original vocal.
- **[Zoom]**: during video play, zoom in/out to pan through the image.
- **[Repeat]**: choose a repeat play option or turn off the repeat function.
- **[GOTO]**: during video play, specify a position to start play by entering the desired time or number.
- **[Slow Backward] & [Slow Forward]**: during video play, select a slow backward/forward speed.

# 6 Enjoy karaoke

You can connect a microphone (not supplied) to sing along with a music source.



## Note

- Before you connect a microphone, set the microphone volume to the minimum to prevent howling.

- 1 Insert a Karaoke disc.
- 2 Connect a microphone to the **MIC IN** jack on this product.
- 3 Press **▲**, and then select **[Karaoke]**.
- 4 Turn on the microphone sound output (see "Adjust karaoke settings").
- 5 Play a Karaoke disc and sing through the microphone.

---

## Adjust Karaoke settings

- **[Microphone]**: turn on or off the microphone sound output.
- **[Mic Volume]**: adjust the microphone volume.
- **[Echo Level]**: adjust echo level.
- **[Karaoke Scoring]**: turn off the function of Karaoke scoring or select a scoring level (basic/intermediate/advance). If a level is selected, the score is displayed after each song ends.
- **[Karaoke Idol]**: compete for singing up to four songs among different signers, and the contest result is displayed.

- 
- 1) In the **[Karaoke Scoring]** option, select a level (basic/intermediate/advance).
  - 2) In the **[Karaoke Idol]** option, turn on the contest.  
↳ The song selection menu is displayed.
  - 3) Input a track (VCD/SVCD) or a title/ chapter (DVD) as the first song. Up to four songs can be selected.
  - 4) Then select **[Start]**, and press **OK** to start play selected songs.  
↳ After all the selected songs end, a contest result is displayed.
- 

- **[Key Shift]**: adjust the pitch level that matches your voice.
- **[Vocal]**: select various Karaoke audio modes, or turn off original vocal.

## 7 Play from Bluetooth-enabled devices

### Note

- The effective operation range between the unit and your Bluetooth enabled device is approximately 10 meters (30 feet).
- Any obstacle between the system and the device can reduce the operational range.
- Compatibility with all Bluetooth devices is not guaranteed.

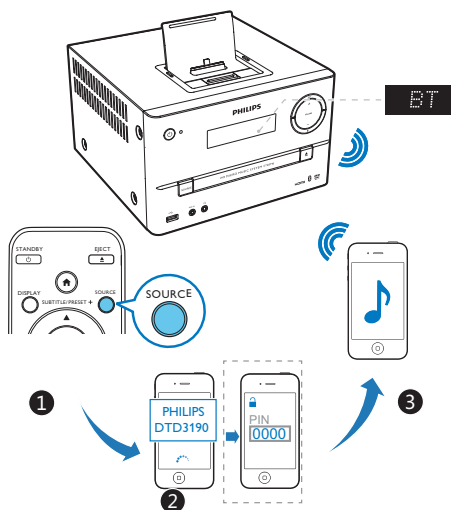

- 1 Press **SOURCE** repeatedly to select the Bluetooth source.  
↳ The power/Bluetooth indicator flashes blue.
- 2 On your device that supports A2DP (Advanced Audio Distribution Profile), enable Bluetooth and search for Bluetooth devices that can be paired (refer to the user manual of the device).

- 3 Select '**PHILIPS DTD3190**' on your Bluetooth enabled device, and input '0000' as the pairing password if necessary.  
↳ After successful pairing and connection, the power/Bluetooth indicator turns solid blue, and the unit beeps twice.
- 4 Play audio on the connected device.  
↳ Audio streams from your Bluetooth enabled device to this unit.

### Tip

- The unit can memorize up to eight previously connected Bluetooth devices.

### To disconnect the Bluetooth-enabled device:

- Deactivate Bluetooth on your device; or
- Move the device beyond the communication range.

### To clear Bluetooth pairing history:

- Press and hold **▶||** for 8 seconds.  
↳ The current Bluetooth connection is disconnected.  
↳ After successful clearing, beep sounds.

## 8 Play iPod/iPhone/iPad

You can enjoy audio from iPod/iPhone/iPad through this unit.

### Compatible iPod/iPhone/iPad

This unit supports the following iPod, iPhone, and iPad models.

Made for

- iPod touch 5th generation
- iPod nano 7th generation
- iPhone 5
- iPad 4
- iPad Mini

### Load the iPod/iPhone/iPad

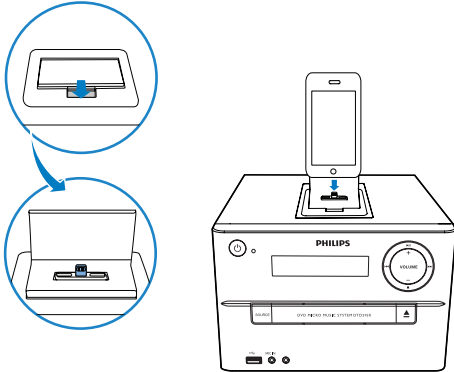

- 1 Lift up the iPod/iPhone/iPad dock on the top panel until you hear a click.
- 2 Place the iPod/iPhone/iPad in the dock.

### Play audio from the iPod/iPhone/iPad

#### Note

- Make sure that your iPod/iPhone/iPad has been loaded securely.
- The audio is only output through the supplied speakers.

- 1 Press **SOURCE** repeatedly to select the iPod/iPhone/iPad source.
- 2 Play audio on your iPod/iPhone/iPad.
  - ↳ The music streams from this device.
  - To pause/resume play, press **▶||**.
  - To skip to a track, press **◀|▶**.
  - To navigate the menu: press **↶** to access the menu, press **▲/▼** to select an item, and then press **OK** to confirm.

### Charge the iPod/iPhone/iPad

When the unit is connected to power; the docked iPod/iPhone/iPad begins to charge automatically.

### Remove the iPod/iPhone/iPad

- 1 Pull the iPod/iPhone/iPad out of the dock.
- 2 Press down to hide the dock.

## 9 Listen to the radio

Connect an FM antenna to this device before listening to the radio.

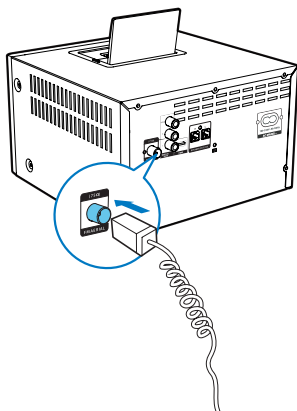

### Tune to a radio station

#### Tip

- Position the antenna as far as possible from TV, VCR, or other radiation source.
- For optimal reception, fully extend and adjust the position of the antenna.

- 1 Press **SOURCE** repeatedly to select **FM** source.
- 2 Press and hold **◀/▶** (**◀◀/▶▶**) for more than two seconds.
  - ↳ The radio tunes to a station with strong reception automatically.
- 3 Repeat step 2 to tune to more stations.

#### To tune to a weak station:

Press **◀/▶** (**◀◀/▶▶**) repeatedly until you find optimal reception.

### Program radio stations automatically

#### Note

- You can program a maximum of 20 preset radio stations (FM).

In tuner mode, press and hold **PROG** for more than two seconds to activate automatic programming.

- ↳ **[AUTO]** (auto) is displayed.
- ↳ All available stations are programmed in the order of waveband reception strength, and the first programmed radio station is broadcast automatically.

### Program radio stations manually

- 1 Tune to a radio station.
- 2 Press **PROG**, and then press **▲/▼** to select a number from 1–20.
- 3 Press **PROG** to confirm.
  - ↳ **[SAVE]** (save) is displayed.
- 4 Repeat steps 2-3 to program more stations.

#### Note

- To overwrite a programmed station, store another station in its place.

### Select a preset radio station

In tuner mode, press **PRESET +/-** (**▲/▼**) (or press a numeric key directly) to select a preset radio station.

## Show RDS information

Radio Data System (RDS) is a service that allows FM stations to show additional information. If you tune to an RDS station, an RDS icon and the station name are displayed.

- 1 Tune to an RDS station.
- 2 Press **RDS** repeatedly to scroll through the following information (if available):
  - ↳ Station name
  - ↳ Program type such as **[NEWS]** (news), **[SPORT]** (sport), **[POP M]** (pop music)...
  - ↳ Frequency

### Note

- There are definitions of RDS program types (see 'Product information' > 'RDS program types').

## Synchronize clock with RDS station

You can synchronize the clock time on the unit with an RDS station.

- 1 Tune to an RDS radio station that transmits time signals.
- 2 Press **RDS** for over two seconds.
  - ↳ **[CT SYNC]** is displayed and the unit reads RDS time automatically.

### Note

- The accuracy of the transmitted time depends on the RDS station that transmits the time signal.

# 10 Listen to an external device

You can listen to an external device through this unit with an audio cable.

- 1 Press **SOURCE** repeatedly to select **AUDIO IN** source.
- 2 Connect an audio cable (not supplied) between:
  - the **AUDIO IN (L and R)** sockets on the back of the unit.
  - the audio output sockets on the external audio device.
- 3 Start to play the device (see the device user manual).

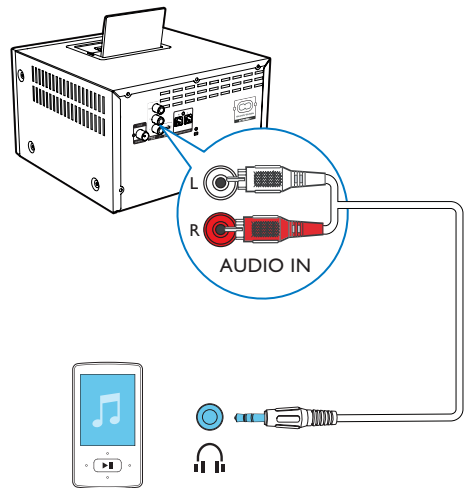

# 11 Other features

## Set the sleep timer

To set the sleep timer; in turn on mode, press **TIME/SLEEP** repeatedly to select a set period of time (in minutes).

↳ When sleep timer is activated, **z z** is displayed.

### To deactivate sleep timer:

Press **TIME/SLEEP** repeatedly until **[SLP OFF]** (sleep off) is displayed.

↳ When sleep timer is deactivated, **z z** disappears.

## Set the alarm timer

This unit can be used as an alarm clock. You can select CD, FM, USB, or iPod/iPhone/iPad as alarm source.

### Note

- Make sure that you have set the clock correctly.

- 1 In standby mode, press and hold **TIME/SLEEP** for more than two seconds.  
↳ The hour digits are displayed and begin to blink.
- 2 Press **▲ / ▼** (or **+/-**) repeatedly to set hour.
- 3 Press **TIME/SLEEP** to confirm.  
↳ The minute digits are displayed and begin to blink.
- 4 Repeat steps 2-3 to set minute, select a source (disc, USB, tuner, or iPod/iPhone/iPad), and adjust volume.

### Note

- If no button is pressed in 90 seconds, the system exits timer setting mode automatically.

### To activate or deactivate the alarm timer:

Press **TIME/SLEEP** repeatedly to activate or deactivate the alarm.

↳ If timer is activated, **🔔** is displayed.

### Tip

- If disc/USB/iPod/iPhone/iPad source is selected, but no disc is placed or no USB/iPod/iPhone/iPad connected, the system switches to the tuner source automatically.

# 12 Adjust settings

- 1 Press **⬆**.
- 2 Select the **[Setup]** page.
- 3 Select a setting and press **OK**.
  - To return to the previous menu, press **⬅**.
  - To exit the menu, press **⬆**.

## General setup

On the **[General]** page, you can set the following options:

**[Disc Lock]**: Lock or unlock a disc.

**[OSD Language]**: Select the preferred language for on-screen display.

**[DivX(R) VOD Code]**: Display the DivX(R) registration code.

### Note

- Enter this DivX registration code when you rent or purchase a video from <http://vod.divx.com/>. The DivX videos rented or purchased through the DivX® VOD (Video On Demand) service can be played only on the device to which it is registered.

## Video setup

On the **[Video]** page, you can set the following options:

**[TV System]**: Change this setting if the video is not displayed correctly. By default, this setting matches the most common setting for TVs in your country.

- **[PAL]**- For TV with PAL color system.
- **[Multi]**- For TV that is compatible with both PAL and NTSC.
- **[NTSC]**- For TV with NTSC color system.

**[TV Display]** (TV display): The TV format determines the aspect ratio of display according to the type of TV you have connected.



- **[4:3 Pan Scan]**- For 4:3 screen TV: full-height display with the trimmed sides.
- **[4:3 Letter Box]**- For 4:3 screen TV: wide-screen display with black bars on the top and bottom of the screen.
- **[16:9]**- For wide-screen TV: display ratio 16:9.

**[Picture Setting]**: Select a predefined set of picture color settings.

- **[Standard]**- Original color setting.
- **[Bright]**- Vibrant color setting.
- **[Soft]**- Soft color setting.
- **[Personal]**- Customizes the color setting. Set the level of brightness, contrast, tint, and color saturation, and then press **OK**.

**[HD JPEG]** (HD JPEG): Select a predefined set of picture color settings.

**[HDMI Setup]**: Access the following setup through HDMI connection.

- **[Resolution]**: Select a resolution for high definition videos.
- **[HDMI Deep Color]**: Recreate the natural world on your TV screen by displaying vivid images using billion colors. Your home theater must be connected to a Deep Color enabled TV through an HDMI cable.
- **[Wide Screen]**: Select a display format for wide screen videos.
- **[EasyLink Setup]**: Set up EasyLink control.

## Audio setup

On the **[Audio]** page, you can set the following options:

**[HDMI Audio]**: Set the HDMI audio output from your TV, or disable HDMI audio output from the TV.



**[Audio Sync]:** Set audio delay if audio and video cannot be matched.

**[Sound Mode]:** Turn off or select your preferred sound mode.

- **[Original]** (original)
- **[Movie Mode]**
- **[Music Mode]**
- **[Gaming]** (gaming)
- **[News]** (news)

**[Night Mode]:** Make loud sound level softer and soft sound level louder so that you can watch the DVD movies at a low volume, without disturbing others.

- **[On]**- enjoy quiet viewing at night (DVDs only).
- **[Off]**- enjoy surround sound with its full dynamic range.

## Preferences

On the **[Preference]** page, you can set the following options:

**[Audio]:** Select the preferred audio language for disc play.

**[Subtitle]:** Select the preferred subtitle language for disc play.

**[Disc Menu]:** Select the preferred disc menu language.

### Note

- If the language you have set is not available on the disc, the disc uses its own default language.
- For some discs, the subtitle/audio language can only be changed from the disc menu.

**[Parental Control]:** Restrict access to discs that are unsuitable for children. These types of discs must be recorded with ratings.

- 1) Press **OK**.
- 2) Select a rating level, and then press **OK**.
- 3) Press the numeric keys to enter the password.

### Note

- Rated discs above the level you set in **[Parental Control]** require a password to be played.
- The ratings are country-dependent. To allow all discs to play, select **[8 Adult]**.
- Some discs have ratings printed on them but are not recorded with ratings. This function has no effect on such discs.

**[PBC]:** Play VCD interactively according to the menu screen.

- **[On]**- the menu screen is displayed.
- **[Off]**- normal play is resumed.

**[Password]:** This setting allows you to change the password for parental control. The default password is 000000.

- 1) Press the numeric keys to enter '000000' or your last set password at **[Old Password]** field.
- 2) Enter the new password at **[New Password]** field.
- 3) Enter the new password again at **[Confirm PWD]** field.
- 4) Press **OK** to exit the menu.

### Note

- If you forget the password, enter '000000' before you set a new password.

**[DivX Subtitle]:** Select a character set that supports the DivX subtitle.

### Note

- Ensure that the subtitle file has the exact same file name as the movie file. If for example the file name of the movie is 'Movie.avi', and then you will need to name the text file 'Movie.sub' or 'Movie.srt'.

**[Version Info]:** Display the software version of this device.

**[Default]:** Reset all the settings to factory default, except for the password and parental settings.

# 13 Product information



## Note

- Product information is subject to change without prior notice.

## Specifications

### Amplifier

Maximum Output Power	150 W
Frequency Response	60 Hz - 16 kHz; ±3 dB
Signal to Noise Ratio	≥70 dB
Total Harmonic Distortion	<1%
Aux Input	600 mV RMS

### Speakers

Speaker Impedance	6 ohm
Speaker Driver	4" woofer + 20 mm tweeter
Sensitivity	>83 dB/m/W

### Bluetooth

Bluetooth version	V2.1 + EDR
Frequency band	2.4 GHz ~ 2.48 GHz ISM Band
Range	10 m (free space)

### Tuner (FM)

Tuning Range	87.5-108 MHz
Tuning grid	50 KHz
Sensitivity	
- Mono, 26dB S/N Ratio	<22 dBf
- Stereo, 46dB S/N Ratio	<45 dBf
Search Selectivity	<30 dBf
Total Harmonic Distortion	<3%
Signal to Noise Ratio	>45 dB

### USB

USB Direct Version	2.0 full speed
USB 5V Power	≤500 mA

### Disc

Laser Type	Semiconductor
Disc Diameter	12 cm/8 cm
Video Decoding	MPEG-1 / MPEG-2 / DivX
Video DAC	12 Bits
Signal System	PAL / NTSC
Video Format	4:3 / 16:9
Video S/N	>57 dB
Audio DAC	24 Bits / 96 kHz
Total Harmonic Distortion	<1% (1 kHz)
Frequency Response	4 Hz - 20 kHz (44.1 kHz) 4 Hz - 22 kHz (48 kHz) 4 Hz - 24 kHz (96 kHz)
Frequency Response	60 Hz - 16 kHz; ±3 dB
S/N Ratio	>70 dBA

### General information

AC power	100-240V~, 50/60 Hz
Operation Power Consumption	68 W

Eco Standby Power Consumption	<0.5 W
<b>Dimensions</b>	
- Main Unit (W x H x D)	230 x 195 x 235 mm
- Speaker Box (W x H x D)	142 x 307 x 215 mm
<b>Weight</b>	
- Main Unit	2.5 kg
- Speaker Box	2 x 2.8 kg

## Supported disc formats

- Digital Video Discs (DVDs)
- Video CDs (VCDs)
- SuperVideo CDs (SVCDs)
- Digital Video Discs + Rewritable (DVD+RW)
- Compact Discs (CDs)
- Picture (Kodak, JPEG) files on CDR(W)
- DivX(R) disc on CD-R(W):
- DivX 3.11, 4.x and 5.x

### Supported MP3-CD formats:

- ISO 9660
- Max. title/album name: 12 characters
- Max. title number plus album: 255.
- Max. nested directory: 8 levels.
- Max. album number: 32.
- Max. MP3 track number: 999.
- Supported sampling frequencies for MP3 disc: 32 kHz, 44.1 kHz, 48 kHz.
- Supported Bit-rates of MP3 disc are: 32, 64, 96, 128, 192, 256 (kbps).

### Unsupported disc format:

- Files like \*.VMA, \*.AAC, \*.DLF, \*.M3U, \*.PLS, \*.WAV
- Non-English Album/Title name
- Discs recorded in Joliet format
- MP3 Pro and MP3 with ID3 tag

## USB playability information

### Compatible USB devices:

- USB flash memory (USB2.0 or USB1.1)
- USB flash players (USB2.0 or USB1.1)
- memory cards (requires an additional card reader to work with this unit)

### Supported USB formats:

- USB or memory file format: FAT12, FAT16, FAT32 (sector size: 512 bytes)
- MP3 bit rate (data rate): 32-320 Kbps and variable bit rate
- Directory nesting up to a maximum of 8 levels
- Number of albums/ folders: maximum 99
- Number of tracks/titles: maximum 999
- ID3 tag v2.0 or later
- File name in Unicode UTF8 (maximum length: 32 bytes)

### Unsupported USB formats:

- Empty albums: an empty album is an album that does not contain MP3/WMA files, and will not be shown in the display.
- Unsupported file formats are skipped. For example, word documents (.doc) or MP3 files with extension .dlf are ignored and not played.
- WMA, AAC, WAV, PCM audio files
- DRM protected WMA files (.wav, .m4a, .m4p, .mp4, .aac)
- WMA files in Lossless format

## RDS program types

NO TYPE	No RDS programme type
NEWS	News services
AFFAIRS	Politics and current affairs
INFO	Special information programs
SPORT	Sports
EDUCATE	Education and advanced training
DRAMA	Radio plays and literature
CULTURE	Culture, religion and society

SCIENCE	Science
VARIED	Entertainment programs
POP M	Pop music
ROCK M	Rock music
MOR M	Light music
LIGHT M	Light classical music
CLASSICS	Classical music
OTHER M	Special music programs
WEATHER	Weather
FINANCE	Finance
CHILDREN	Children's programs
SOCIAL	Social Affairs
RELIGION	Religion
PHONE IN	Phone In
TRAVEL	Travel
LEISURE	Leisure
JAZZ	Jazz Music
COUNTRY	Country Music
NATION M	National Music
OLDIES	Oldies Music
FOLK M	Folk Music
DOCUMENT	Documentary
TES	Alarm Test
ALARM	Alarm

# 14 Troubleshooting



## Warning

- Never remove the casing of this device.

To keep the warranty valid, never try to repair the system yourself.

If you encounter problems when using this device, check the following points before requesting service. If the problem remains unsolved, go to the Philips Web page ([www.philips.com/support](http://www.philips.com/support)). When you contact Philips, make sure that the device is nearby and the model number and serial number are available.

### No power

- Make sure that the AC power cord of the device is connected properly.
- Make sure that there is power at the AC outlet.
- As a power-saving feature, the system switches off automatically 15 minutes after track play reaches the end and no control is operated.

### No sound or poor sound

- Adjust the volume.
- Check that the speakers are connected correctly.
- Check if the stripped speaker wires are clamped.

### Remote control does not work

- Before you press any function button, first select the correct source with the remote control instead of the main unit.
- Reduce the distance between the remote control and the unit.
- Insert the battery with its polarities (+/- signs) aligned as indicated.
- Replace the battery.
- Aim the remote control directly at the sensor on the front of the unit.

**Audio or subtitle languages cannot be set**

- The disc is not recorded with sound or subtitles in multiple languages.
- The audio or subtitle language setting is prohibited on the disc.

**When you switch on the TV, the home theater automatically switches on.**

- This behavior is normal when you are using Philips EasyLink (HDMI-CEC). To make the home theater work independently, switch off EasyLink.

**No disc detected**

- Insert a disc.
- Check if the disc is inserted upside down.
- Wait until the moisture condensation at the lens has cleared.
- Replace or clean the disc.
- Use a finalized CD or correct format disc.

**Disc does not play**

- Insert a readable disc with the label side facing you.
- Check the disc type, color system and regional code. Check for any scratches or smudges on the disc.
- Press **▲** to exit the system setup menu.
- Disable the password for parental control or change the rating level.
- Moisture has condensed inside the system. Remove the disc and leave the system turned on for about an hour. Disconnect and reconnect the AC power plug, and then turn on the system again.

**No picture**

- Check the video connection.
- Turn on the TV to the correct Video-In channel.

**Black and white or distorted picture**

- The disc does not match the TV color system standard (PAL/NTSC).
- Sometimes a slight picture distortion may appear. This is not a malfunction.
- Clean the disc.

**The aspect ratio of the TV screen cannot be changed even though you have set the TV display format.**

- The aspect ratio is fixed on the loaded DVD disc.
- The aspect ratio may not be changed for some TV systems.

**DivX video files cannot be played.**

- Ensure that the DivX video file is complete.
- Ensure that the file extension is correct.
- Due to Digital Rights issue, the DRM-protected video files cannot be played through an analog video connection (e.g. composite, component and scart). Transfer the video content onto the Disc Media and play these files.

**EasyLink does not work.**

- Make sure that the home theater is connected to a Philips brand EasyLink TV, and the EasyLink option is turned on.
- For TVs from different manufacturers, the HDMI CEC could be called differently. Check the TV user manual on how to enable it.

**Cannot display some files in USB device**

- The number of folders or files in the USB device has exceeded a certain limit. This phenomenon is not a malfunction.
- The formats of these files are not supported.

**USB device not supported**

- The USB device is incompatible with the unit. Try another one.

**Poor radio reception**

- Increase the distance between the unit and your TV or VCR.
- Fully extend the FM antenna.

**Music playback is unavailable on this unit even after successful Bluetooth connection.**

- The device cannot be used to play music through this unit wirelessly.

### **The audio quality is poor after connection with a Bluetooth-enabled device.**

- The Bluetooth reception is poor. Move the device closer to this unit or remove any obstacle between them.

### **Cannot connect with this unit.**

- The device does not support the profiles required for this unit.
- The Bluetooth function of the device is not enabled. Refer to the user manual of the device to find out how to enable the function.
- This unit is not in pairing mode.
- This unit is already connected with another Bluetooth-enabled device. Disconnect that device and then try again.

### **The paired mobile device connects and disconnects constantly.**

- The Bluetooth reception is poor. Move the device closer to this unit or remove any obstacle between them.
- Some mobile phones may connect and disconnect constantly when you make or end calls. This does not indicate any malfunction of this unit.
- For some devices, the Bluetooth connection may be deactivated automatically as a power-saving feature. This does not indicate any malfunction of this unit.

### **Timer does not work**

- Set the clock correctly.
- Switch on the timer.

### **Clock/timer setting erased**

- Power has been interrupted or the power cord has been disconnected.
- Reset the clock/timer.

## 15 Notice

Any changes or modifications made to this device that are not expressly approved by WOOX Innovations may void the user's authority to operate the equipment.

Your product is designed and manufactured with high quality materials and components, which can be recycled and reused.

Never dispose of your product with other household waste. Please inform yourself about the local rules on the separate collection of electrical and electronic products and batteries. The correct disposal of these products helps prevent potentially negative consequences on the environment and human health.

Your product contains batteries, which cannot be disposed of with normal household waste. Please inform yourself about the local rules on separate collection of batteries. The correct disposal of batteries helps prevent potentially negative consequences on the environment and human health.

Please visit [www.recycle.philips.com](http://www.recycle.philips.com) for additional information on a recycling center in your area.

### **Environmental information**

All unnecessary packaging has been omitted. We have tried to make the packaging easy to separate into three materials: cardboard (box), polystyrene foam (buffer) and polyethylene (bags, protective foam sheet.)

Your system consists of materials which can be recycled and reused if disassembled by a specialized company. Please observe the local regulations regarding the disposal of packaging materials, exhausted batteries and old equipment.



**Be responsible  
Respect copyrights**

This item incorporates copy protection technology that is protected by U.S. patents

and other intellectual property rights of Rovi Corporation. Reverse engineering and disassembly are prohibited.

## Bluetooth

The Bluetooth® word mark and logos are registered trademarks owned by Bluetooth SIG, Inc. and any use of such marks by WOOX Innovations is under license.



HDMI, and HDMI logo, and High-Definition Multimedia Interface are trademarks or registered trademarks of HDMI licensing LLC in the United States and other countries.



'DVD Video' is a trademark of DVD Format/Logo Licensing Corporation.

## **DivX™**

ABOUT DIVX VIDEO: DivX® is a digital video format created by DivX, LLC, a subsidiary of Rovi Corporation. This is an official DivX Certified® device that plays DivX video. Visit [divx.com](http://divx.com) for more information and software tools to convert your files into DivX videos. ABOUT DIVX VIDEO-ON-DEMAND: This DivX Certified® device must be registered in order to play purchased DivX Video-on-Demand (VOD) movies. To obtain your registration code, locate the DivX VOD section in your device setup menu. Go to [vod.divx.com](http://vod.divx.com) for more information on how to complete your registration.

DivX®, DivX Certified® and associated logos are trademarks of Rovi Corporation or its subsidiaries and are used under license.



Manufactured under license from Dolby Laboratories.

"Dolby" and the double-D symbol are trademarks of Dolby Laboratories.

This apparatus includes this label:



"Made for iPod," "Made for iPhone," and "Made for iPad" mean that an electronic accessory has been designed to connect specifically to iPod, iPhone, or iPad, respectively, and has been certified by the developer to meet Apple performance standards. Apple is not responsible for the operation of this device or its compliance with safety and regulatory standards. Please note that the use of this accessory with iPod, iPhone, or iPad may affect wireless performance.

iPod and iPhone are trademarks of Apple Inc., registered in the U.S. and other countries. iPad is a trademark of Apple Inc.

### Note

- The type plate is located on the back of the device.



2014 ©WOOX Innovations Limited.All rights reserved.  
Philips and the Philips' Shield Emblem are registered  
trademarks of Koninklijke Philips N.V. and are used by WOOX  
Innovations Limited under license from Koninklijke Philips N.V.

DTD3190\_98\_UM\_V4.0

