

Always there to help you

Register your product and get support at
www.philips.com/welcome

HTD3510
HTD3540
HTD3570



Quick start guide

PHILIPS



- EN** Before using your product, read all accompanying safety information
- MS-MY** Sebelum menggunakan produk anda, baca semua maklumat keselamatan yang disertakan
- TH** ก่อนใช้งานผลิตภัณฑ์ของคุณ โปรดอ่านข้อมูลด้านความปลอดภัยที่มีให้โดยละเอียด

- ZH-CN** 使用产品前，请阅读所有随附的安全信息
- ZH-TW** 使用您的產品前，請先閱讀所有附隨的安全資訊



HTD3510

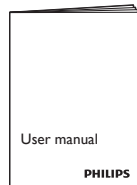
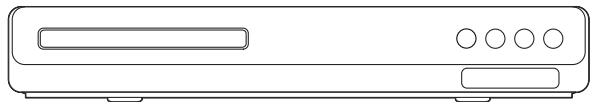
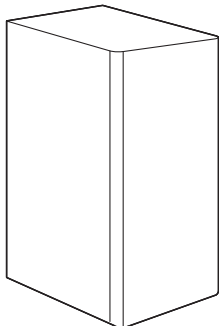
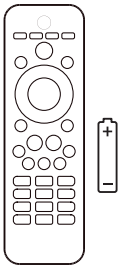

Power Cord

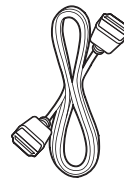

HDMI

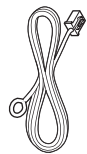

FM Antenna



HTD3540

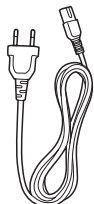
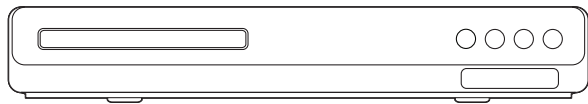
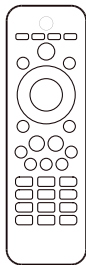
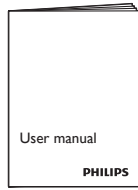

Power Cord

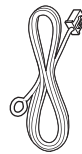

FM antenna



HDMI

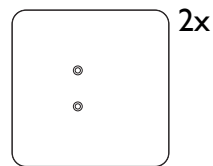
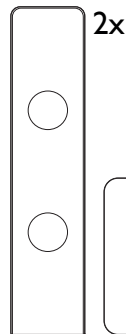
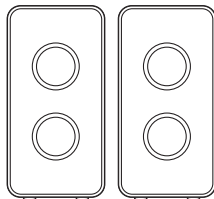
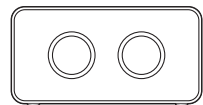
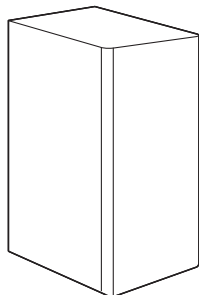

HTD3570

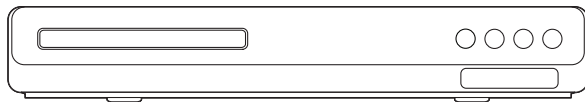
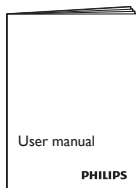
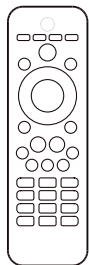

HDMI

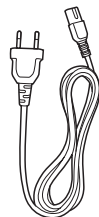

Power Cord

FM antenna

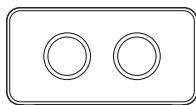
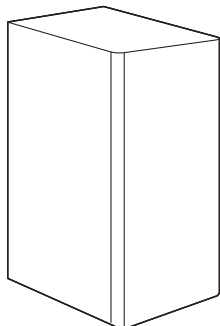
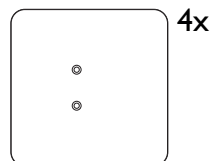
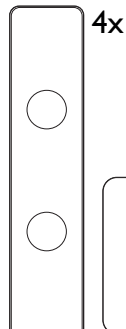
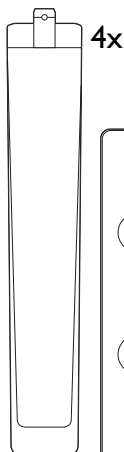

1

EN Stand mount the speakers
Applied to HTD3540 and HTD3570 only

MS Dirikan dirian pembesar suara
Hanya digunakan pada HTD3540 dan HTD3570 sahaja

TH วางลำโพงบนขาตั้ง
เคवल HTD3540 और HTD3570 पर लागू

ZH-CN 桌架和扬声器
仅适用于 HTD3540 和 HTD3570

ZH-TW 將喇叭安裝到立架上 TWCN
僅適用於 HTD3540 和 HTD3570

1

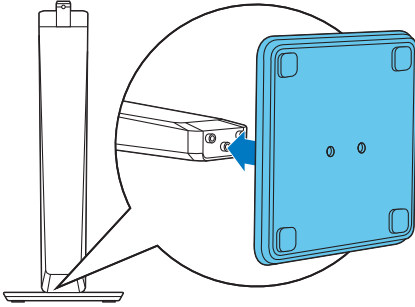

2

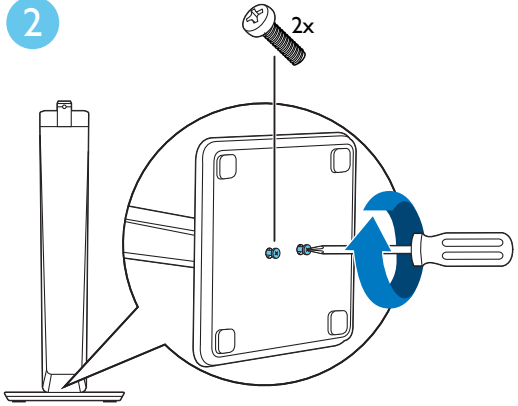

3

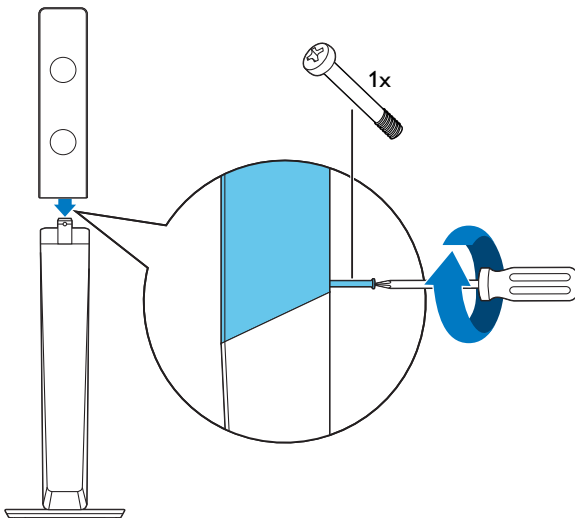

2

- EN** Connect and position the home theater
- MS-MY** Sambungkan dan posisikan sistem teater rumah
- TH** เชื่อมต่อและวางตำแหน่งโอมเซียร์เตอร์
- ZH-CN** 连接和放置家庭影院
- ZH-TW** 連線並將家庭劇院定位擺好

HTD3510

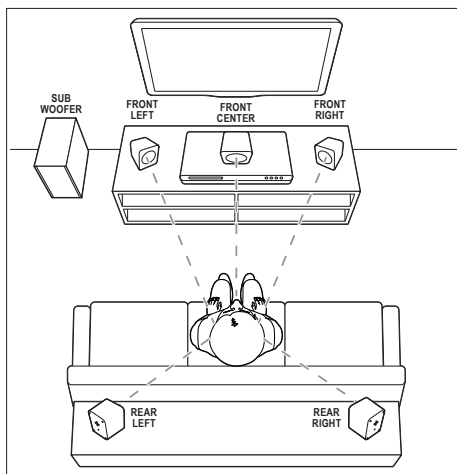
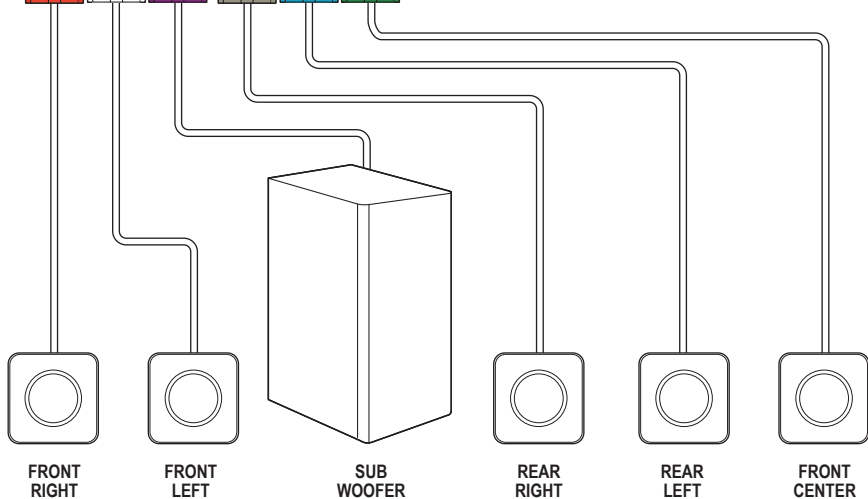
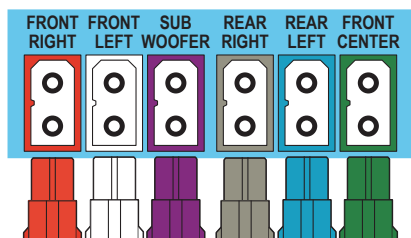
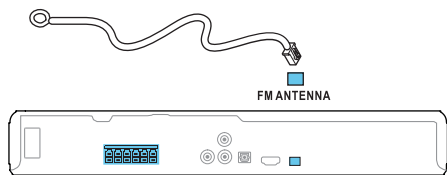

HTD3540

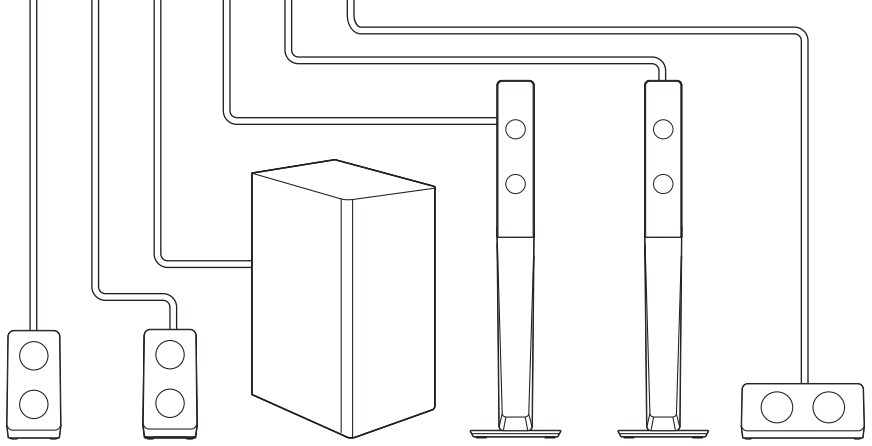
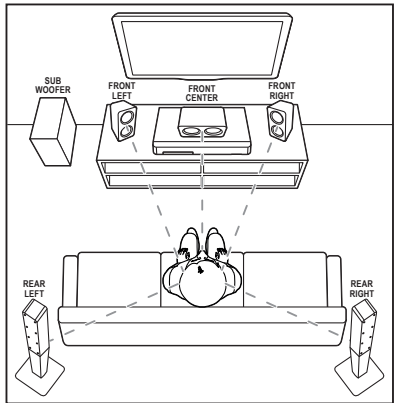
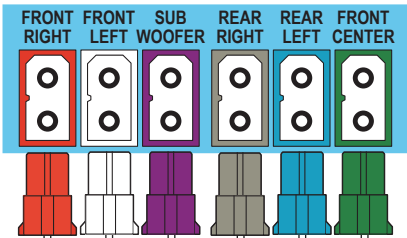
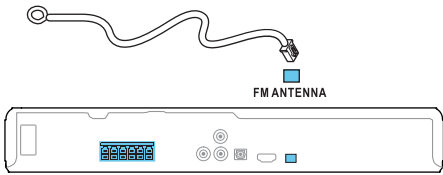

FRONT RIGHT FRONT LEFT SUB WOOFER REAR RIGHT REAR LEFT FRONT CENTER

HTD3570

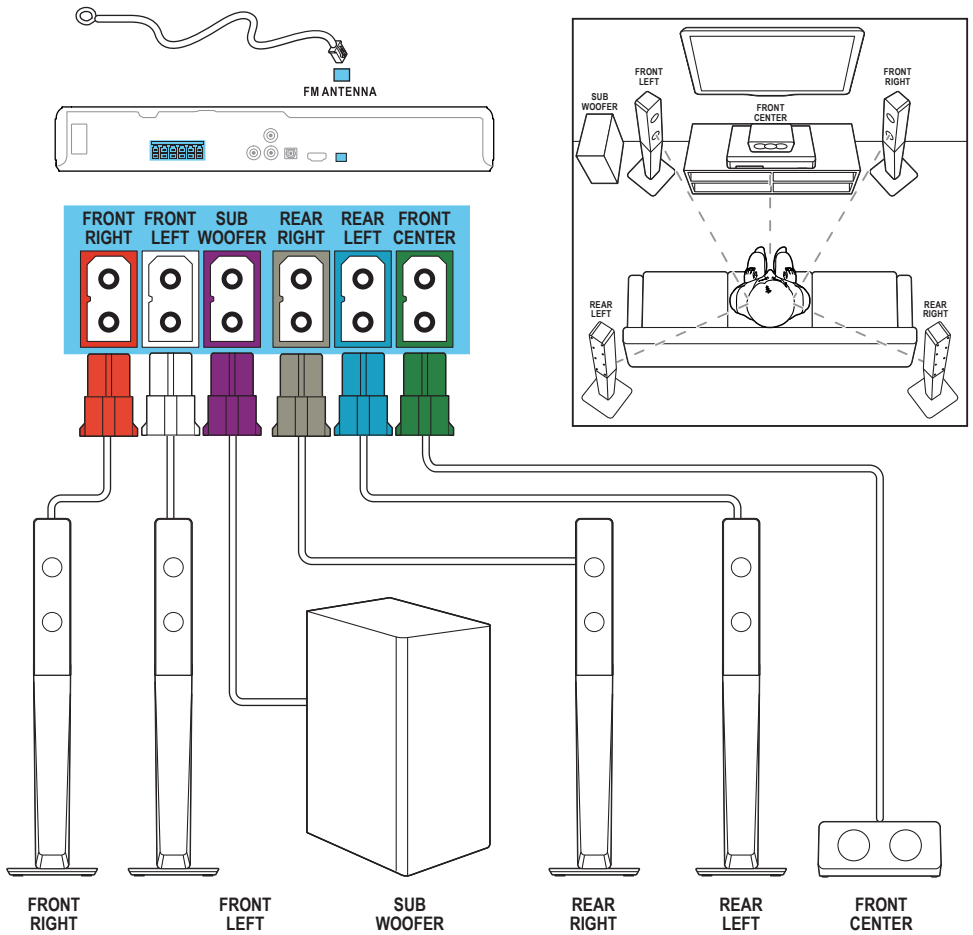

3

EN Connect to TV in one of these ways

MS-MY Sambung kepada TV dalam salah satu cara berikut

TH เชื่อมต่อทีวีด้วยวิธีใดวิธีหนึ่งดังนี้

ZH-CN 通过这些方式连接至电视

ZH-TW 用這些方式之一連線到電視

HDMI ARC

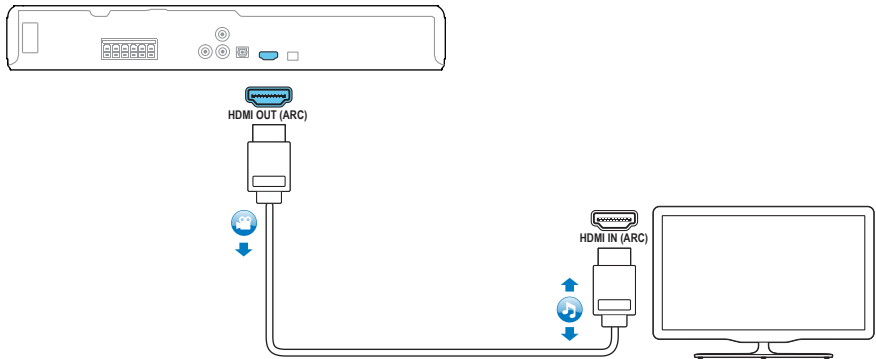

HDMI + OPTICAL

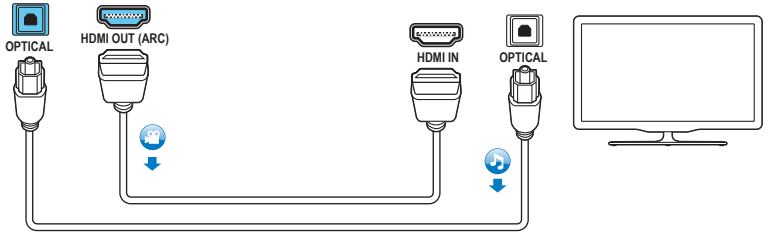
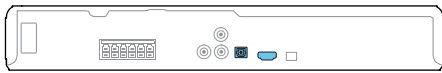

VIDEO + AUDIO L/R

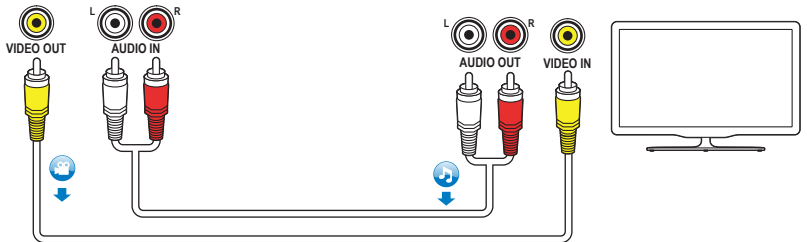
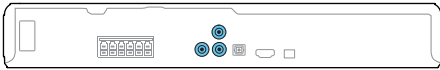

4

EN Switch on the home theater

MS-MY Hidupkan teater rumah

TH เปิดโฮมเธียเตอร์

ZH-CN 打开家庭影院

ZH-TW 開啟家庭劇院

1

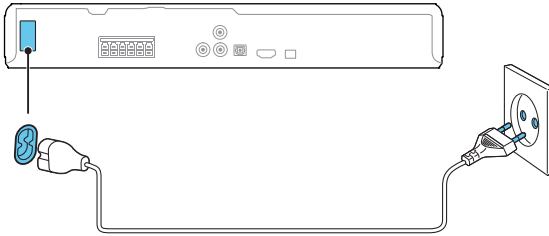

2

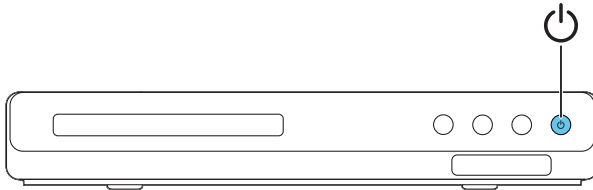

3

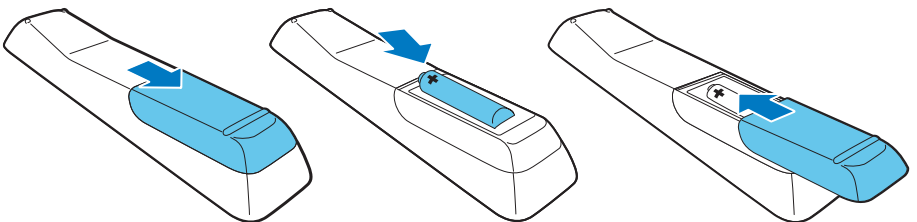

5

EN Complete the first time setup

MS-MY Lengkapi persediaan kali pertama

TH ตั้งค่าครั้งแรกให้เสร็จสมบูรณ์

ZH-CN 完成首次设置

ZH-TW 完成首次設定

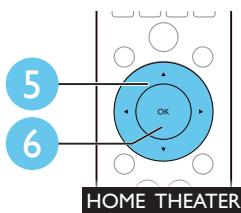
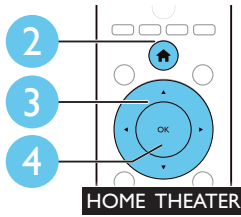
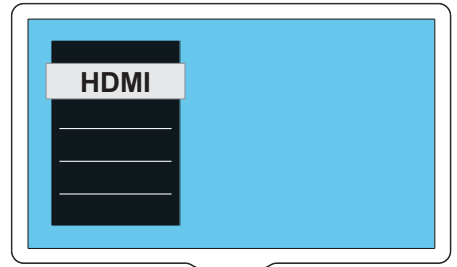
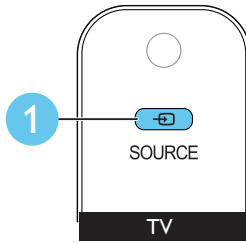

6

EN Use your home theater

MS-MY Gunakan teater rumah anda

TH ใช้โฮมเธียเตอร์ของคุณ

ZH-CN 使用家庭影院

ZH-TW 使用您的家庭劇院

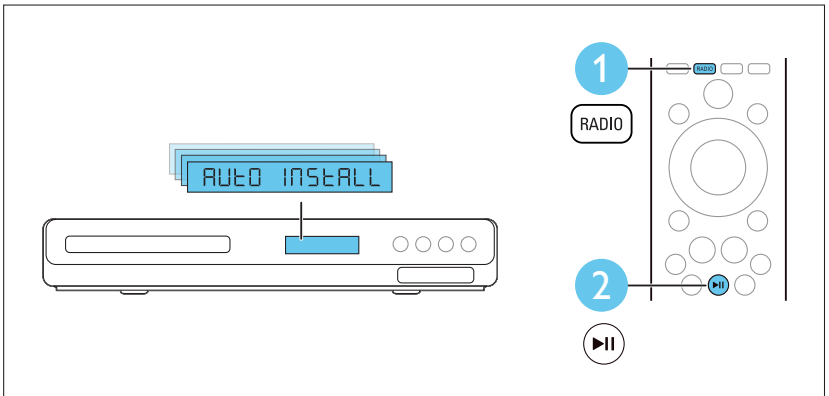
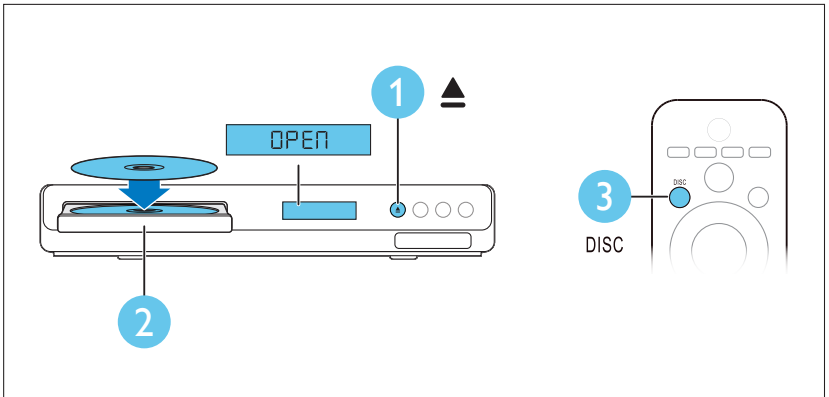

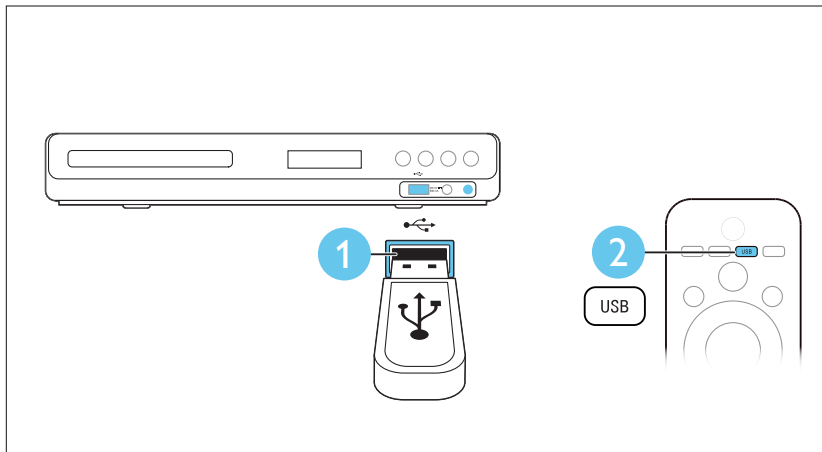
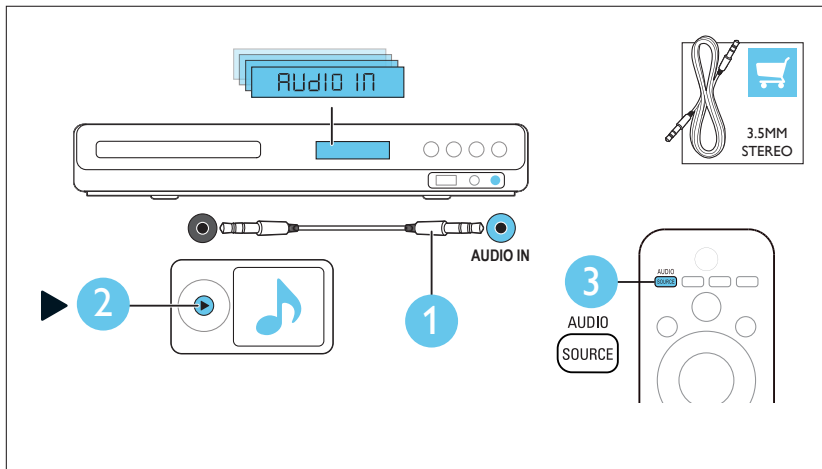



Specifications are subject to change without notice
© 2013 Koninklijke Philips Electronics N.V.
All rights reserved.

HTD3510/3540/3570_98_QSG_V1.0

