

Register your product and get support at  
[www.philips.com/welcome](http://www.philips.com/welcome)

HTS3011

**STOP!** Thank you for choosing Philips.

**Need help fast?**

Read your Quick Start Guide and/or User Manual first for quick tips that make using your Philips product more enjoyable.

**Register your product and get support at [www.philips.com/welcome](http://www.philips.com/welcome)**

or call  
**1-888-PHILIPS (744-5477)**  
while with your product  
(and Model / Serial number)

**ARRÊT!** Philips vous remercie de votre confiance.

**Besoin d'une aide rapide?**

Le Guide rapide de début et Manuel de l'utilisateur regorgent d'astuces destinées à simplifier l'utilisation de votre produit Philips.

**Enregistrez votre produit et accédez à l'assistance sur [www.philips.com/welcome](http://www.philips.com/welcome)**

ou formez le  
**1-800-661-6162 (Francophone)**  
**1-888-PHILIPS (744-5477)**  
(English speaking)  
Veuillez à avoir votre produit à portée de main  
(et model / serial nombre)

**ALTO!** Gracias por escoger Philips

**Necesita ayuda inmediata?**

Lea primero la Guía rápida del comienzo o el Manual del usuario, en donde encontrará consejos que le ayudarán a disfrutar plenamente de su producto Philips.

**Visite [www.philips.com/welcome](http://www.philips.com/welcome) para registrar su producto y obtener información de contacto y asistencia.**

o llame al teléfono  
**1-888-PHILIPS (744-5477)**  
y tenga a mano el producto  
(y número de model / serial)

EN	DVD Home Theater System	6
FR_CA	Système Home Cinéma DVD	52
ES_LA	Sistema de Home Theater con DVD	100



# PHILIPS

**Return your Product Registration Card or register online at  
[www.philips.com/welcome](http://www.philips.com/welcome) today to get the very most from your purchase.**

Registering your model with PHILIPS makes you eligible for all of the valuable benefits listed below, so don't miss out. Complete and return your Product Registration Card at once, or register online at [www.philips.com/welcome](http://www.philips.com/welcome) to ensure:

**\*Proof of Purchase**

Returning the enclosed card guarantees that your date of purchase will be on file, so no additional paperwork will be required from you to obtain warranty service.

**\*Product Safety Notification**

By registering your product, you'll receive notification - directly from the manufacturer - in the rare case of a product recall or safety defect.

**\*Additional Benefits**

Registering your product guarantees that you'll receive all of the privileges to which you're entitled, including special money-saving offers.

**PHILIPS**

*Congratulations on your purchase, and welcome to the "family!"*

**Dear PHILIPS product owner:**

Thank you for your confidence in PHILIPS. You've selected one of the best-built, best-backed products available today. We'll do everything in our power to keep you happy with your purchase for many years to come.

As a member of the PHILIPS "family," you're entitled to protection by one of the most comprehensive warranties and outstanding service networks in the industry. What's more, your purchase guarantees you'll receive all the information and special offers for which you qualify, plus easy access to accessories from our convenient home shopping network.

Most importantly, you can count on our uncompromising commitment to your total satisfaction.

All of this is our way of saying welcome - and thanks for investing in a PHILIPS product.

**P.S. To get the most from your PHILIPS purchase, be sure to complete and return your Product Registration Card at once, or register online at:**

**[www.philips.com/welcome](http://www.philips.com/welcome)**

Know these **safety symbols**



**⚡** This "bolt of lightning" indicates uninsulated material within your unit may cause an electrical shock. For the safety of everyone in your household, please do not remove product covering.

**!** The "exclamation point" calls attention to features for which you should read the enclosed literature closely to prevent operating and maintenance problems.

**WARNING:** To reduce the risk of fire or electric shock, this apparatus should not be exposed to rain or moisture and objects filled with liquids, such as vases, should not be placed on this apparatus.

**CAUTION:** To prevent electric shock, match wide blade of plug to wide slot, fully insert.

**ATTENTION:** Pour éviter les choc électriques, introduire la lame la plus large de la fiche dans la borne correspondante de la prise et pousser jusqu'au fond.

**For Customer Use**

Enter below the Serial No. which is located on the rear of the cabinet. Retain this information for future reference.

Model No. \_\_\_\_\_  
 Serial No. \_\_\_\_\_

**PHILIPS**

Visit our World Wide Web Site at <http://www.philips.com/welcome>

# IMPORTANT SAFETY INSTRUCTIONS

1. Read these instructions.
2. Keep these instructions.
3. Heed all warnings.
4. Follow all instructions.
5. Do not use this apparatus near water.
6. Clean only with dry cloth.
7. Do not block any ventilation openings. Install in accordance with the manufacturer's instructions.
8. Do not install near any heat sources such as radiators, heat registers, stoves, or other apparatus (including amplifiers) that produce heat.

9. Do not defeat the safety purpose of the polarized or grounding-type plug.

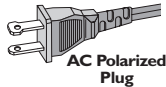

A polarized plug has two blades with one wider than the other. A grounding type plug has two blades and a third grounding prong. The wide blade or the third prong are provided for your safety. If the provided plug does not fit into your outlet, consult an electrician for replacement of the obsolete outlet.

10. Protect the power cord from being walked on or pinched, particularly at plugs, convenience receptacles, and the point where they exit from the apparatus.
11. Only use attachments/accessories specified by the manufacturer.

12.  Use only with the cart, stand, tripod, bracket, or table specified by the manufacturer or sold with the apparatus. When a cart is used, use caution when moving the cart/apparatus combination to avoid injury from tip-over.

13. Unplug this apparatus during lightning storms or when unused for long periods of time.

14. Refer all servicing to qualified service personnel. Servicing is required when the apparatus has been damaged in any way, such as power-supply cord or plug is damaged, liquid has been spilled or objects have fallen into the apparatus, the apparatus has been exposed to rain or moisture, does not operate normally, or has been dropped.

15. Battery usage **CAUTION** – To prevent battery leakage which may result in bodily injury, property damage, or damage to the unit:

- Install **all** batteries correctly, + and - as marked on the unit.
- Do not mix batteries (**old** and **new** or **carbon** and **alkaline**, etc.).
- Remove batteries when the unit is not used for a long time.

16. Apparatus shall not be exposed to dripping or splashing.

17. Do not place any sources of danger on the apparatus (e.g. liquid filled objects, lighted candles).

18. This product may contain lead and mercury. Disposal of these materials may be regulated due to environmental considerations.

**For disposal or recycling information, please contact your local authorities or the Electronic Industries Alliance : [www.eiae.org](http://www.eiae.org).**

Ensure that the power outlet is always within reach. If abnormal situations occur, fully disconnect power: unplug the power cord from the power outlet.

**EL 6475-E005: 04/01**

**Class II equipment symbol**   
This symbol indicates that the unit has a double insulation system

## LASER

Type	Semiconductor laser GaAlAs
Wave length	645 - 660 nm (DVD) 770 - 800 nm (CD)
Output Power	6 mW (DVD) 7 mW (VCD/CD)
Beam divergence	60 degrees

## Canada

### English:

This digital apparatus does not exceed the Class B limits for radio noise emissions from digital apparatus as set out in the Radio Interference Regulations of the Canadian Department of Communications.

This Class B digital apparatus complies with Canadian ICES-003.

### Français:

Cet appareil numérique n'émet pas de bruits radioélectriques dépassant les limites applicables aux appareils numériques de Class B prescrites dans le Règlement sur le Brouillage Radioélectrique édicté par le Ministère des Communications du Canada.

Cet appareil numérique de la classe B est conforme à la norme NMB-003 du Canada.

This warning label is located on the rearside and inside this laser product.

**CAUTION** INVISIBLE LASER RADIATION WHEN OPEN. DO NOT STARE INTO BEAM.

**DANGER** INVISIBLE LASER RADIATION WHEN OPEN. AVOID DIRECT EXPOSURE TO BEAM.

**VARO!** AVATTAESSA JA SUOJALUKITUS OHITETTAESSA. OLET ALTTIINANAKYMATTOMMAALLE LASERSATEILYLLE. ALA KATSO SATEESEEN.

**WARNING!** OSYNLIG LASERSTRÅLNING NÄR DENNA DEL ÄR ÖPPNAD. OCH SPÄRREN ÄR URKOPPLAD. BETRÄKTA EJ STRÅLEN.

or

**DANGER** - Invisible laser radiation when open. AVOID DIRECT EXPOSURE TO BEAM.

## CAUTION

Use of controls or adjustments or performance of procedures other than herein may result in hazardous radiation exposure or other unsafe operation.

## ATTENTION

L'utilisation des commandes ou réglages ou le non-respect des procédures ciincluses peuvent se traduire par une exposition dangereuse à l'irradiation.

## ATENCIÓN

El uso de mando o ajustes o la ejecución de métodos que no sean los aquí descritos puede ocasionar peligro de exposición a radiación.

## Declaration of Conformity

Model number: HTS3011  
Trade Name: Philips  
Responsible Party: Philips Consumer Electronics  
A Division of Philips Electronics  
North America Corp.  
P.O. Box 671539  
Marietta, GA 30006-0026  
1-800-PHILIPS (744-5477)

Due to the inconsistency of disc formats provided by various disc manufacturers, your DVD system/ player/recorder may require a playability enhancement or upgrade. As DVD technology advances, these enhancement will become common and will be easy to complete. Go to [www.philips.com/support](http://www.philips.com/support) for software upgrade.

## Environmental information

All unnecessary packaging has been omitted. We have tried to make the packaging easy to separate into three materials: cardboard (box), polystyrene foam (buffer) and polyethylene (bags, protective foam sheet.) Your system consists of materials which can be recycled and reused if disassembled by a specialized company. Please observe the local regulations regarding the disposal of packaging materials, exhausted batteries and old equipment.

# Index



Manufactured under license from Dolby Laboratories. Dolby, Pro Logic and the double-D symbol are trademarks of Dolby Laboratories.



DivX, DivX Ultra Certified, and associated logos are trademarks of DivX, Inc. and are used under license.

Official DivX® Ultra Certified product.

Plays all versions of DivX® video (including DivX® 6) with enhanced playback of DivX® media files and the DivX® Media Format.



Windows Media and the Windows logo are trademarks, or registered trademarks of Microsoft Corporation in the United States and/or other countries.



ENERGY STAR and the ENERGY STAR mark are registered U.S. marks

'CONSUMERS SHOULD NOTE THAT NOT ALL HIGH DEFINITION TELEVISION SETS ARE FULLY COMPATIBLE WITH THIS PRODUCT AND MAY CAUSE ARTIFACTS TO BE DISPLAYED IN THE PICTURE. IN CASE OF 525 OR 625 PROGRESSIVE SCAN PICTURE PROBLEMS, IT IS RECOMMENDED THAT THE USER SWITCH THE CONNECTION TO THE 'STANDARD DEFINITION' OUTPUT. IF THERE ARE QUESTIONS REGARDING OUR TV SET COMPATIBILITY WITH THIS MODEL 525p AND 625p DVD PLAYER, PLEASE CONTACT OUR CUSTOMER SERVICE CENTER.'

English ----- 6

Français-----52

Español ----- 100

English

Français

Español

**NOTE:** This equipment has been tested and found to comply with the limits for a Class B digital device, pursuant to Part 15 of the FCC Rules. These limits are designed to provide reasonable protection against harmful interference in a residential installation. This equipment generates, uses and can radiate radio frequency energy and, if not installed and used in accordance with the instructions, may cause harmful interference to radio communications. However, there is no guarantee that interference will not occur in a particular installation.

If this equipment does cause harmful interference to radio or television reception, which can be determined by turning the equipment off and on, the user is encouraged to try to correct the interference by one or more of the following measures:

- Reorient or relocate the receiving antenna.
- Increase the separation between the equipment and receiver.
- Connect the equipment into an outlet on a circuit different from that to which the receiver is connected.
- Consult the dealer or an experienced radio/TV technician for help.

This product incorporates copyright protection technology that is protected by method claims of certain U.S. patents and other intellectual property rights owned by Macrovision Corporation and other rights owners. Use of this copyright protection technology must be authorized by Macrovision Corporation, and is intended for home and other limited viewing uses only unless otherwise authorized by Macrovision Corporation. Reserve engineering or disassembly is prohibited.

# Table of contents

## General

<b>General Information .....</b>	<b>8</b>
Setup precautions.....	8
Accessories supplied .....	8
Cleaning discs .....	8
About recycling.....	8

## Product Overview

<b>Main Unit .....</b>	<b>9</b>
<b>Remote Control.....</b>	<b>10-12</b>
Using the remote control.....	12

## Connections

<b>Basic Connections .....</b>	<b>13-18</b>
Step 1: Placing the speakers.....	13
Step 2: Connecting to TV .....	14
Option 1: Connecting to the Video jack.....	14
Option 2: Connecting to a Progressive Scan TV or component video input.....	15
Option 3: Using an accessory RF modulator .....	16
Step 3: Connecting speakers and subwoofer .....	17
Step 4: Connecting the FM antenna.....	18
Step 5: Connecting the power cord.....	18
<b>Optional Connections .....</b>	<b>19</b>
Connecting audio from other devices.....	19

## Basic Setup

<b>Getting Started.....</b>	<b>20-24</b>
Finding the correct viewing channel .....	20
Switching to different play source .....	20
Setting language preferences.....	21-22
On-screen display (OSD) language.....	21
Audio, Subtitle and Menu language for DVD playback.....	21-22
Setting up Progressive Scan feature.....	23
Setting the speakers' channels.....	24

## Disc Playback

<b>Disc Operations .....</b>	<b>25-32</b>
Playable discs .....	25
Playing a disc .....	25
Basic playback controls.....	26
Selecting various repeat/shuffle functions.....	26
Other playback features for video discs (DVD/VCD/SVCD).....	27-29
Using the Disc menu .....	27
Viewing playback information.....	27
Zooming.....	28
Changing subtitle language .....	28
Switching camera angles.....	28
Changing sound track language.....	28
Setting the delay times for audio playback.....	28
Playback Control (VCD/SVCD only).....	29
Preview function (VCD/SVCD only).....	29

# Table of contents

Playing a MP3/ WMA disc .....	30
Playing a JPEG image file (slide show) .....	31
Preview function .....	31
Zooming.....	31
Skip/Rotate picture.....	31
Playing music and photo files simultaneously .....	32
Playing a DivX® disc .....	32

## Setup Options

<b>Setup Menu Options.....</b>	<b>33-40</b>
Accessing the setup menu.....	33-40
General Setup .....	34
Audio Setup .....	35
Video Setup.....	36-37
Preferences .....	38-40

## Radio Tuning

<b>Radio Operations.....</b>	<b>41-42</b>
Tuning to radio stations.....	41
Presetting radio stations .....	41
Using auto install .....	41
Using automatic preset.....	42
Using manual preset.....	42
Selecting a preset radio station.....	42
Deleting a preset radio station.....	42

## Others

<b>Sound and Volume Controls .....</b>	<b>43</b>
Volume control .....	43
Selecting surround sound.....	43
Selecting digital sound effects.....	43
<b>Other Features.....</b>	<b>44</b>
Installing the latest software .....	44
<b>Troubleshooting.....</b>	<b>45-46</b>
<b>Specifications .....</b>	<b>47</b>
<b>Glossary.....</b>	<b>48-49</b>

## General Information

### **WARNING!**

This unit does not contain any user-serviceable parts. Please leave all maintenance work to qualified personnel.

### Setup precautions

#### **Finding a suitable location**

- Place this unit on a flat, hard and stable surface. Never place the unit on a carpet.
- Never place this unit on top of other equipment that might heat it up (e.g., receiver or amplifier).
- Never put anything under this unit (e.g., CDs, magazines).
- Install this unit near the AC outlet where the AC power plug can be easily reached.

#### **Space for ventilation**

- Place this unit in a location with adequate ventilation to prevent internal heat build up. Allow at least 10 cm (4") clearance from the rear and the top of this unit and 5cm (2") from the left and right to prevent overheating.

#### **Avoid high temperature, moisture, water and dust**

- This unit must not be exposed to dripping or splashing.
- Never place any object or items that can damage this unit (e.g., liquid filled objects, lighted candles).

### Accessories supplied

- 1 subwoofer
- 2 front speakers
- 2 rear speakers
- 1 center speaker
- 1 remote control with batteries
- 1 composite video cable (yellow)
- 1 FM wire antenna
- Quick Start Guide

### Cleaning discs

To clean a disc, use a micro fibre cleaning cloth and wipe the disc from the center to the edge in a straight line.

### **CAUTION!**

Never use solvents e.g. benzene, thinner, commercially available cleaners, or anti-static sprays intended for discs.

### About recycling

These operating instructions have been printed on non-polluting paper. The electronic equipment contains a large number of materials that can be recycled. If you are disposing of an old machine, please take it to a recycling center. Please observe the local regulations regarding disposal of packaging materials, exhausted batteries and old equipment.



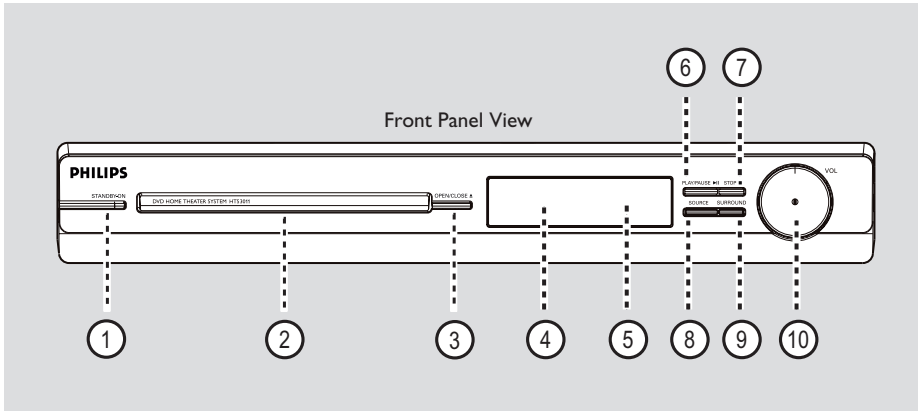

**① STANDBY-ON**

- Turns on this unit or turns off to standby mode.

**② Disc Tray**

**③ OPEN/CLOSE ▲**

- Opens/closes the disc tray.

**④ Display panel**

- Shows information about the current status of the unit.

**⑤ IR Sensor**

- Point the remote control towards this sensor.

**⑥ PLAY/PAUSE ►||**

- DISC: starts/pauses playback.
- RADIO: starts auto radio installation for first time setup.

**⑦ STOP ■**

- Exits an operation.
- DISC: stops playback.
- RADIO: press and hold this button to erase the current preset radio station.

**⑧ SOURCE**

- Selects the relevant active source mode: DISC, FM, AUX 1 or AUX 2.

**⑨ SURROUND**

- Selects multi-channel surround or stereo or party mode.

**⑩ VOL**

- Adjusts the volume level.

# Remote Control

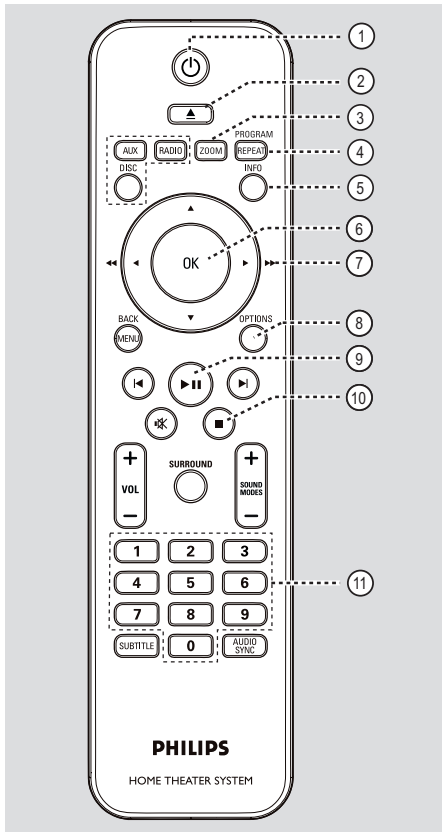

## ① (Standby-On)

- Turns on this unit or turns off to standby mode.

## ② (Open/Close)

- Opens/closes the disc tray.

## ③ ZOOM

- Zoom in or out the picture on the TV.

## ④ REPEAT (PROGRAM)

- DISC: Selects various repeat or shuffle modes; turns off repeat or shuffle mode.
- RADIO: Press this button to start manual preset programming.
- RADIO: Press and hold this button to start automatic preset programming.

## ⑤ INFO

- Displays the current status or disc information.

## ⑥ OK

- Confirms an entry or selection.

## ⑦ ▲▼◀▶

- DISC: selects movement direction in the menu.
- DISC: press left or right for fast forward and backward search.
- RADIO: press up or down to tune the radio frequency.
- RADIO: press left or right to start auto search.

## ⑧ OPTIONS

- Enters or exits the system setup menu.

## ⑨ (Play/Pause)

- DISC: starts/pauses playback.
- RADIO: starts auto radio installation for first time setup.

## ⑩ (Stop)

- Exits an operation.
- DISC: stops playback.
- RADIO: press and hold this button to erase the current preset radio station.

## ⑪ Numeric keypad 0-9

- Enters a track/title/chapter number of the disc.
- Enters a number of a preset radio station.

## Remote Control (continued)

English

### 12 Source buttons

- **AUX:** switches to AUX 1 or AUX 2 external source mode.
- **RADIO:** switches to FM band.
- **DISC:** switches to DISC mode.

### 13 MENU (BACK)

- DVD: go back to title menu.
- VCD/SVCD:  
During playback (PBC ON mode only) return to PBC menu.

### 14 ◀/▶ (Previous/Next)

- DISC: skips to the previous or next title/ chapter/track.
- RADIO: selects a preset radio station.

### 15 🚫 (Mute)

- Mutes or restores the volume.

### 16 SURROUND

- Selects multi-channel surround, stereo or party mode.

### 17 VOL + / –

- Adjusts the volume level.

### 18 SOUND MODES + / –

- Selects a predefined sound effect.

### 19 SUBTITLE

- Selects a DVD subtitle language.

### 20 AUDIO SYNC

- Select an audio language/channel.
- Sets the audio output delay times if the video playback is slower than the audio output.

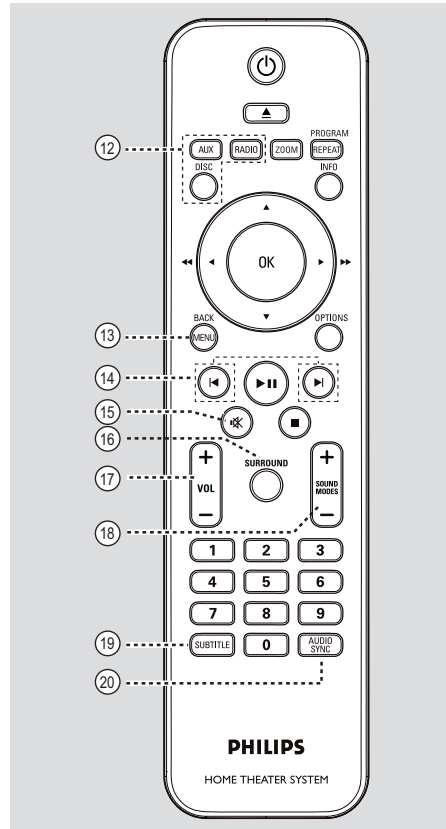

## Remote Control (continued)

### Using the remote control

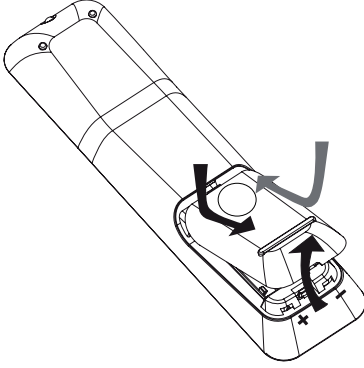

- 1 Push to open the battery compartment.
- 2 Insert two batteries type R03 or AAA, following the indications (+ -) inside the compartment.
- 3 Close the cover.
- 4 Point the remote control directly at the remote sensor (iR) on the front panel.
- 5 Select the source you wish to control by pressing the AUX, RADIO or DISC button on the remote control.
- 6 Then select the desired function (for example ◀, ▶).

### CAUTION!

- Remove batteries if they are exhausted or if the remote control is not to be used for a long time.
- Never mix batteries (old and new or carbon and alkaline, etc).
- Batteries contain chemical substances, they should be disposed of properly.

## Basic Connections

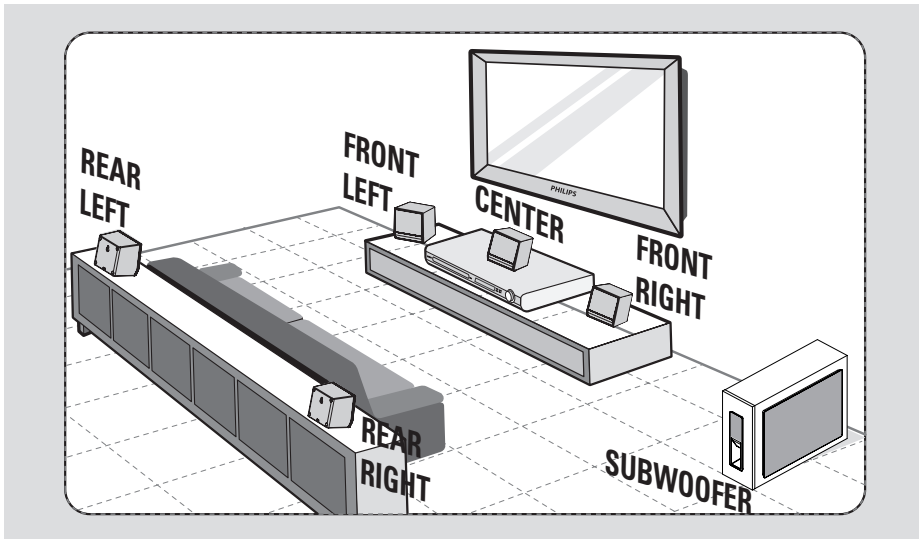

### Step 1: Placing the speakers

The Philips Home Theater System is simple to install. However, proper system placement is critical to ensure an optimum sound experience.

- 1 Place the front left and right speakers at equal distances from the TV and at an angle of approximately 45 degrees from the listening position.
- 2 Place the center speaker above the TV or the main unit such that the center channel's sound is localized.
- 3 Place the rear speakers at normal listening ear level facing each other or hang on the wall.
- 4 Place the subwoofer at the corner of the room. Otherwise, keep it at least one metre away from the TV.

#### Helpful Hints:

- The placement diagram shown here is only a guideline that provides great system performance. You may find other placement choices that are more suitable for your room layout that provide the sound experience you enjoy.
- To avoid magnetic interference, never position the front speakers too close to your TV.
- The rear speakers are labelled as REAR LEFT or REAR RIGHT.
- The front speakers are labelled as FRONT LEFT or FRONT RIGHT.
- For speaker setting, see 'Getting Started - Setting the speakers' channels'.

## Basic Connections (continued)

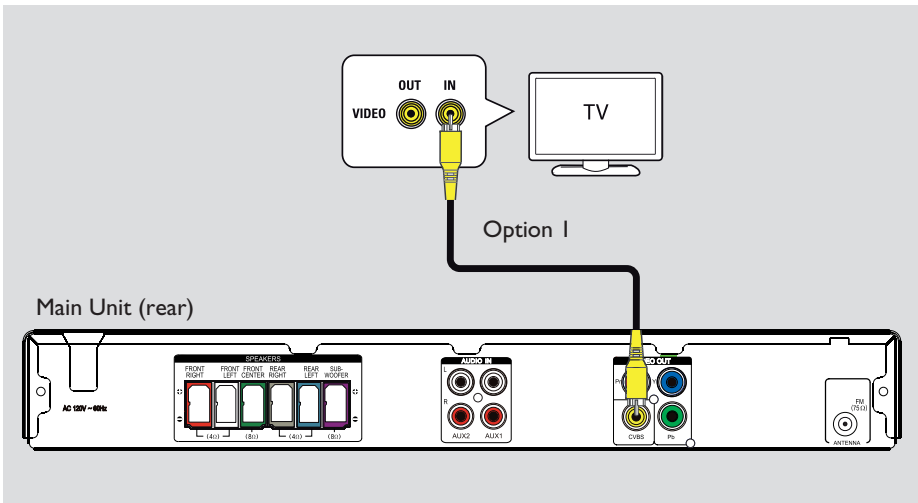

### Step 2: Connecting to TV

This connection enables you to view the video playback from this unit. You only need to choose **one** of the options below to make the video connection.

- For a standard TV, follow option 1.
- For a progressive scan TV, follow option 2.
- For TV with only a single antenna input jack, follow option 3.

#### Helpful Hint:

- It is important to connect this unit directly to the TV in order to enjoy optimum video quality.
- To hear the TV audio through this unit, connect AUDIO IN-AUX jacks on the unit to the audio output on your TV (cables not supplied). Then press AUX until 'AUX 1' or 'AUX 2' is displayed on the front panel.

### Option 1: Connecting to the Video jack

- Use a composite video cable (yellow - supplied) to connect the **CVBS** jack on the main unit to the video input jack (or labeled as A/V In, Video In, Composite or Baseband) on the TV.
  - ➔ It provides good picture quality.

## Basic Connections (continued)

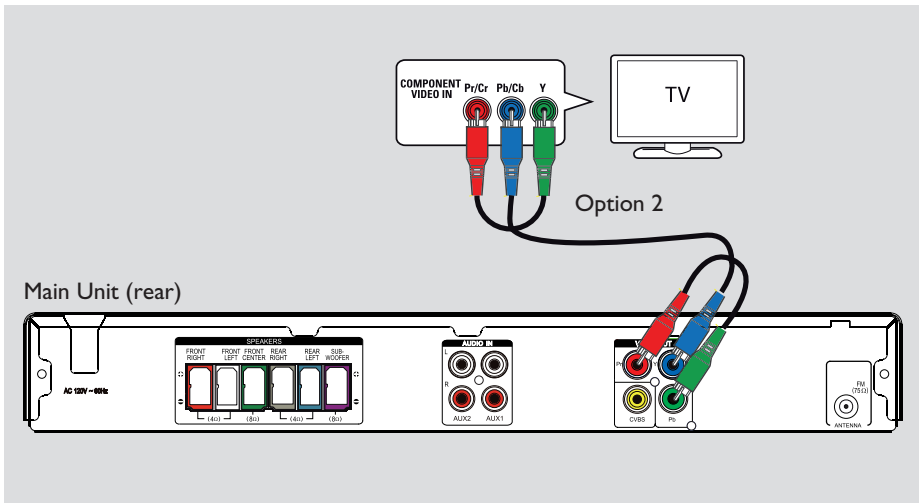

### Option 2: Connecting to a Progressive Scan TV or component video input

The progressive scan video quality is only available when using Y Pb Pr connection and a progressive scan TV is required. It provides superior picture quality when watching DVD movies.

- 1 Use the component video cables (red/blue/green - not supplied) to connect the **Y Pb Pr** jacks on the main unit to the corresponding component video input jacks (or labeled as Y Pb/Cb Pr/Cr or YUV) on the TV.  
→ It provides better picture quality.
- 2 If your TV accepts progressive signals, proceed to chapter 'Getting Started - Setting up Progressive Scan feature' for detailed progressive feature setup.

## Basic Connections (continued)

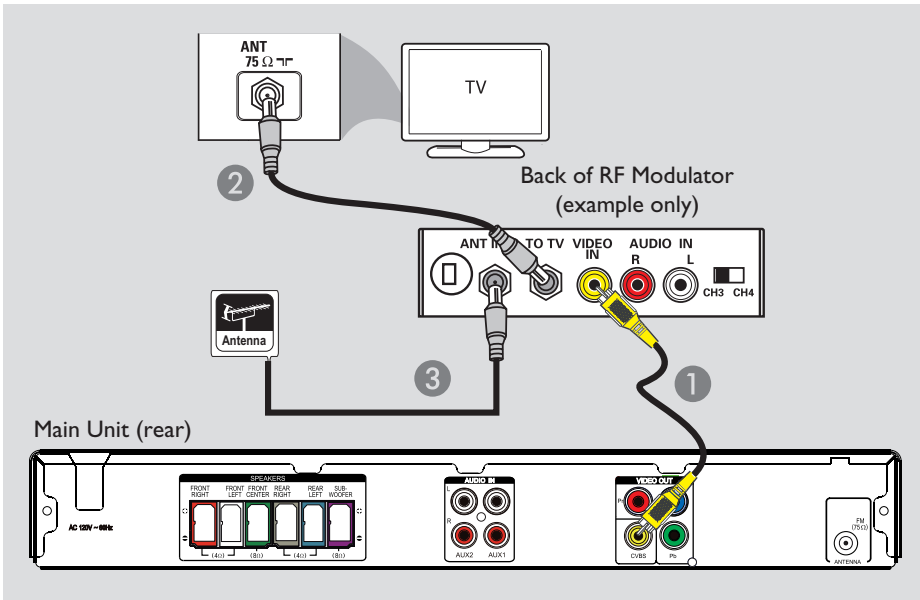

### Option 3: Using an accessory RF modulator

If your TV has only a single Antenna Input jack (labeled as 75 ohm or RF In,) you need an RF modulator in order to view the DVD playback on the TV. See your electronics retailer or contact Philips for details about RF modulator availability and operations.

- 1 Use the supplied composite video cable (yellow) to connect the **CVBS** jack on the main unit to the video input jack on the RF modulator.
- 2 Use an RF coaxial cable (not supplied) to connect ANTENNA OUT or TO TV jack on the RF modulator to the ANTENNA IN jack on the TV.
- 3 Connect the Antenna or Cable TV service signal to the ANTENNA IN or RF IN jack on the RF modulator. (It may have been connected to your TV previously. Disconnect it from the TV.)



## Basic Connections (continued)

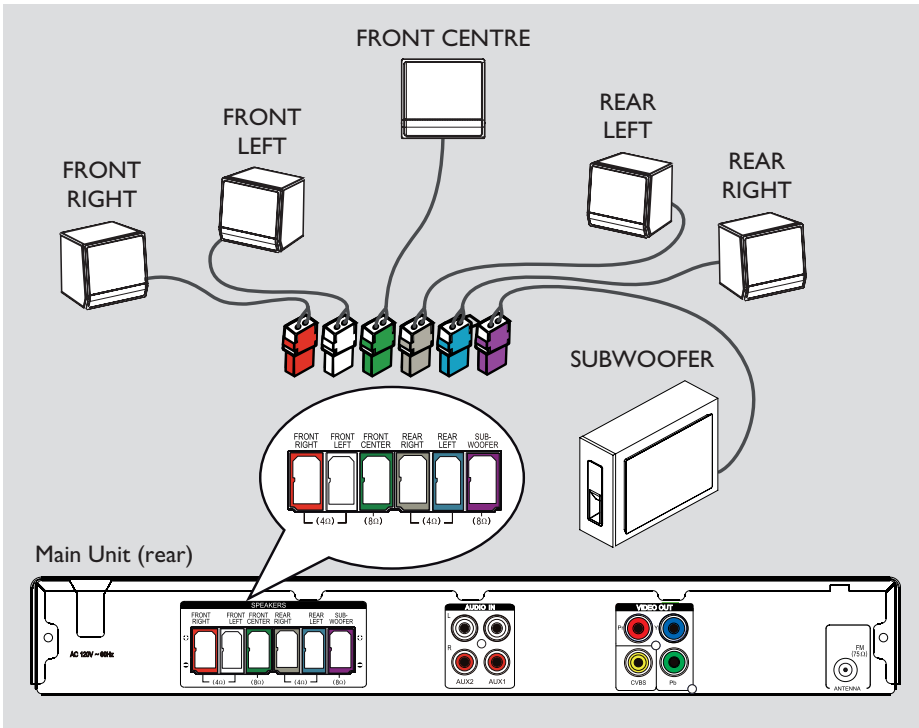

### Step 3: Connecting speakers and subwoofer

- Connect all the speakers and subwoofer to the matching jacks at the rear of the main unit. Make sure that the colors of the cables and jacks are matched.

#### Helpful Hint:

– To prevent unwanted noise, never place the speakers too close to the main unit, subwoofer, AC power adapter, TV or any other radiation sources.

## Basic Connections (continued)

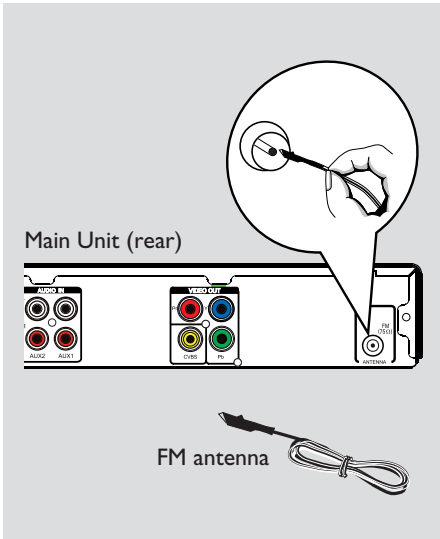

### Step 4: Connecting the FM antenna

- 1 Connect the FM antenna (supplied) to the **FM 75 Ω** socket. (For some models, it has been connected in the factory.)
- 2 Extend the FM antenna and fix its ends to the wall.

For better FM stereo reception, connect an external FM antenna (not supplied).

#### Helpful Hints:

- Adjust the position of the antenna for optimal reception.
- Position the antenna as far away as possible from your TV, VCR or other radiation source to prevent any unwanted interference.

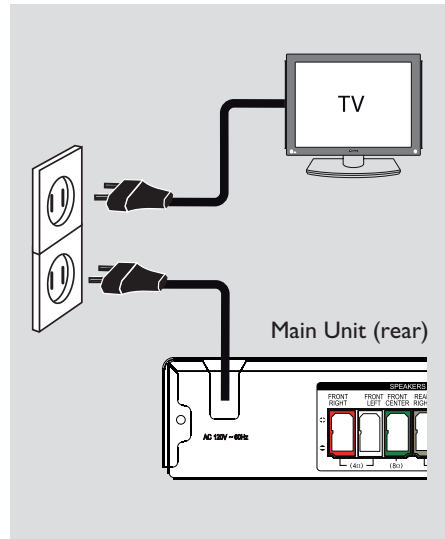

### Step 5: Connecting the power cord

**After everything is connected properly, connect the AC power cord into the power outlet.**

The standby LED on the main unit lights up.

#### Helpful Hints:

- Refer to the type plate at the rear or bottom of the product for identification and supply ratings.
- Before making or changing any connections, make sure that all the devices are disconnected from the power outlet.

## Optional Connections

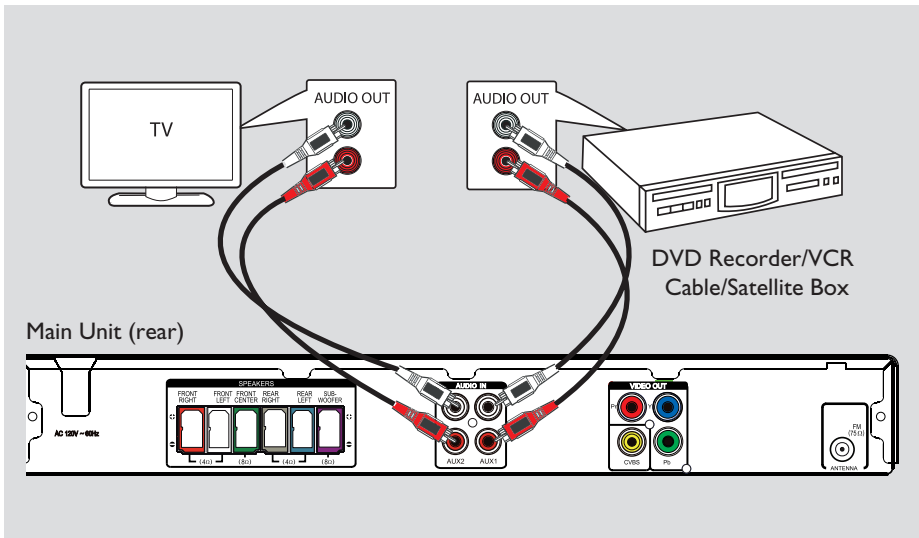

### Connecting audio from other devices

This unit provides analogue audio connection. You can connect the audio output from an audio/video device (e.g. DVD Recorder, VCR, Cable/Satellite Box, game console or TV) to the main unit in order to enjoy the multi-channel surround sound capabilities.

- Use an audio cable (not supplied) to connect the **AUDIO IN-AUX1** or **AUDIO IN-AUX2** jacks on the main unit to the **AUDIO OUT** jacks on the connected device.

To listen to the audio output from this connection, press **AUX** repeatedly until 'AUX 1' or 'AUX 2' is displayed on the front panel.

## Getting Started

### Finding the correct viewing channel

- 1 Press **STANDBY-ON** to turn on the unit.
- 2 Press **DISC** on the remote control.
- 3 Turn on the TV and switch it to the correct video-in channel.
  - You may go to the lowest channel on your TV, then press the Channel Down button on your TV's remote control until you see the Video In channel.
  - You may press  button repeatedly on your TV's remote control.
  - Usually this channel is between the lowest and highest channels and may be called FRONT, A/V IN, VIDEO, etc..
  - If you are using a RF modulator, set the TV to channel 3 or 4.
  - Refer to your TV's user manual on how to select the correct input on your TV.

### Switching to different play source

#### On the main unit

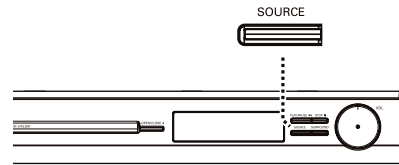

- Press the **SOURCE** button on the main unit repeatedly to select:

DISC → FM → AUX 1 → AUX 2 →  
DISC ....

Or

#### On the remote control

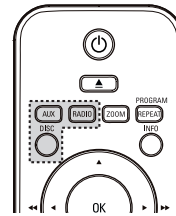

- Press **AUX** repeatedly to hear the audio output from the external device.
  - 'AUX 1' for device connected to AUDIO IN-AUX 1 jacks.
  - 'AUX 2' for device connected to AUDIO IN-AUX 2 jacks.
- Press **RADIO** to switch to FM bandwave.
- Press **DISC** to switch to DISC mode.

## Getting Started (continued)

### Setting language preferences

The language options are different depending on your country or region. It may not correspond to the illustrations shown on the user manual.

#### On-screen display (OSD) language

The OSD (On-Screen Display) language for this unit remains as you have set it, regardless of the changes made to the DVD disc language.

- 1 In disc mode, press **OPTIONS** on the remote control.  
→ { **General Setup** } appears.

- 2 Press **▶**.

- 3 Press **▲▼** keys to select { **OSD Language** }  icon in the menu and press **▶**.

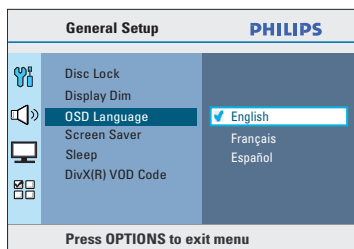

- 4 Use **▲▼** keys to select a language and press **OK** to confirm.

#### Audio, Subtitle and Menu language for DVD playback

You can select your preferred language settings for DVD playback. If the selected language is recorded on the DVD disc, this unit automatically plays the disc in that language. Otherwise, the disc's default language will be used instead.

- 1 Press **■** twice to stop playback (if any), then press **OPTIONS**.
- 2 Press **▼** repeatedly to select { **Preferences** }  icon, and press **▶**.
- 3 Use **▲▼** keys to select one of the options below and press **▶**.

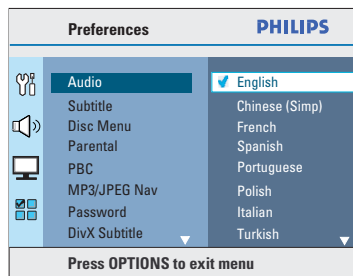

#### { Audio }

Select the preferred audio language for DVD playback.

#### { Subtitle }

Select the preferred subtitle language for DVD playback.

#### { Disc Menu }

Select the preferred disc menu language for DVD playback.

- 4 Use **▲▼** keys to select a language and press **OK** to confirm.

## Getting Started (continued)

---

If the language you want is not available in the list, select { **Others** }.

Use the **numeric keypad (0-9)** on the remote control to enter the 4-digit language code 'XXXX' (see Language Code page) and press **OK** to confirm.

- 5 Repeat steps 3 ~ 4 for other settings.

*Helpful Hints:*

– During DVD playback, you can press the **AUDIO SYNC** and **SUBTITLE** on the remote control to change the audio and subtitle languages respectively. However, this does not change the default settings you have made here.

– For some DVDs, the subtitle/audio/disc menu language can only be changed via the DVD disc menu.

## Getting Started (continued)

### Setting up Progressive Scan feature

(for Progressive Scan TV only)

The progressive scan displays twice the number of frames per second than interlaced scanning (ordinary normal TV system). With nearly double the number of lines, progressive scan offers higher picture resolution and quality.

#### Before you start...

Ensure that you have connected this unit to a progressive scan TV (see 'Option 2: Connecting to a Progressive Scan TV or component video input'.)

- 1 Turn on the TV to the correct viewing channel for this unit.  
→ Make sure that the TV's progressive scan mode is turned off (or set to interlaced mode). Refer to your TV's user manual.
- 2 Turn on this unit and press **DISC** on the remote control.
- 3 Press **OPTIONS** on the remote control.
- 4 Press ▼ repeatedly to select { **Video Setup** } , and press ►.

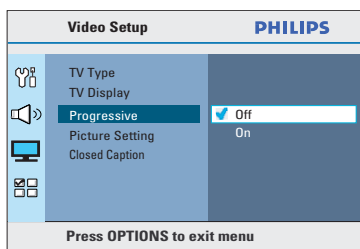

- 5 Move to { **Progressive** } > { **On** } in the menu and press **OK** to confirm.

- 6 Read the notification message on the TV and confirm your action by selecting the { **OK** } in the menu and press **OK**.

**There will be no picture on your TV at this state until you have turned on the progressive scan mode on your TV.**

- 7 Turn on your TV progressive scan mode, refer to your TV's user manual.  
→ A message appears on the TV.
- 8 Confirm your action by selecting the { **OK** } in the menu and press **OK**.  
→ The setup is now completed and you can start to enjoy the high quality picture.

#### If no picture is displayed

- 1 Press ▲ on the main unit.
- 2 Press ◀ on the remote control.
- 3 Press **AUDIO SYNC** on the remote control.

#### Helpful Hints:

- If a blank/distorted screen appears, wait for 15 seconds for the auto recovery.
- There are some progressive scan TVs that are not fully compatible with this unit, resulting in an unnatural picture when playing back a DVD VIDEO disc in the progressive scan mode. In such a case, turn off the progressive scan feature on this unit and your TV.

## Getting Started (continued)

### Setting the speakers' channels

You can adjust the delay times (center and surround only) and volume level for individual speakers. These adjustments let you optimize the sound according to your surroundings and setup.

#### Before you start...

Stop the disc playback by pressing **■** button twice or remove the disc from the disc tray. Otherwise, the settings are not accessible.

- 1 In disc mode, press **OPTIONS** on the remote control.
- 2 Press **▼** repeatedly to select { **Audio Setup** } , and press **▶**.
- 3 Select { **Speakers Volume** } and press **▶**.

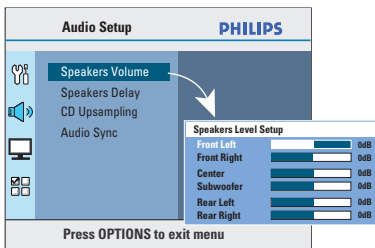

- 4 Use **◀▶** keys to set the volume level for each speaker (-6dB ~ +6dB) and press **OK** to confirm.

- 5 Use **▲▼** keys to highlight { **Speakers Delay** } and press **▶**.

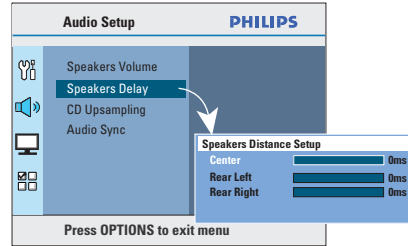

- 6 Use **◀▶** keys to set the delay times (0 ms ~ 15 ms) for center and rear speakers that best suit your surround sound needs.
- 7 Press **OK** to confirm.

#### Helpful Hints:

- A 1ms increase/decrease of delay time is equivalent to 30 cm change in distance.
- Use the longer delay time settings when the rear speakers are closer to the listener than the front speakers.
- The test tone will be generated to help you judge the sound level of each speaker.



## Playable discs



### Your DVD home theater system plays:

- Digital Versatile Discs (DVDs)
- Video CDs (VCDs)
- Super Video CDs (SVCDs)
- Finalized DVD Recordable (DVD±R), DVD Rewritable (DVD±RW)
- Audio Compact Discs (CDs)
- MP3/ Windows Media™ Audio discs, picture (Kodak, JPEG) files on CD-R(W)
  - ISO 9660/UDF format
  - JPEG resolution support up to 3072 x 2048
  - Supported sampling frequencies: 32 kHz, 44.1 kHz, 48 kHz
  - Supported Bit-rates: 32~256 (kbps), variable bit rates (average 128 kbps)
- DivX® files on CD-R(W)/DVD+R(W):
  - DivX® 3/4/5/6, DivX® Ultra

### Region Codes for DVD discs

DVD discs and players are designed with regional restrictions. Before playing a disc, make sure the disc is for the same region as the unit. The regional code for this unit is indicated at the rear or bottom panel.

### Notes:

- If the inhibit icon (Ø or X) appears on the TV when a button is pressed, it means the function is not available on the current disc or at the current time.
- Never put any objects other than discs on the disc tray. Doing so may cause the unit to malfunction.

## Playing a disc

- 1 Press **SOURCE** repeatedly until 'DISC' appears on the display panel (or press **DISC** on the remote control).
- 2 Turn on the TV to the correct viewing channel for this unit.
  - The blue DVD background screen appears on the TV.
- 3 Press ▲ to open the disc tray.
- 4 Load a disc and press ▲ to close the disc tray.
  - Make sure the disc label is facing up. For double-sided discs, load the side which you want to play facing up.
- 5 Playback starts automatically.
  - See the following pages for more playback options and features.

### Helpful Hints:

- If you are having trouble playing a certain disc, remove the disc and try a different one. Improperly formatted discs cannot be played on this unit.
- Some discs cannot be played on this unit due to the configuration and characteristics of the disc, or due to the condition of recording and authoring software that was used.

## Disc Operations (continued)

### Basic playback controls

#### Pausing playback

- During playback, press **▶||**.
  - While in pause mode, you can press **▶** to step forward one frame at each press.
  - To resume playback, press **▶||** again.

#### Selecting another track/chapter

- Press **◀ / ▶** or use the **numeric keypad 0-9** to key in a track/chapter number.
  - If the repeat track mode is active, press **◀** again to replay the same track/chapter.

#### Searching backward/forward

- Press **◀◀ / ▶▶** on the remote control.
  - While searching, press **◀◀ / ▶▶** repeatedly to increase the search speed.
  - To resume normal playback, press **▶||**.

#### Stopping playback

- Press **■**.

#### Helpful Hints:

- If the message 'Playback from the beginning, press **◀**' appears on the TV while you load in a disc, you can press **◀** to start playback from the beginning.
- This is a power-saving feature, this unit automatically switches to standby mode if you do not press any buttons within 15 minutes after a disc has stopped playing.
- Screen saver starts automatically if the disc playback is stopped for about 5 minutes.

### Selecting various repeat/shuffle functions

The available of the repeat play options and shuffle play mode are vary depending on the disc type.

- While playing a disc, press **REPEAT (PROGRAM)** on the remote control repeatedly to choose a repeat or shuffle play mode.

#### DVD

- RPT ONE (repeat chapter)
- RPT TT (repeat title)
- SHUFFLE (random play)
- RPT SHF (repeat random play)
- RPT OFF (exit repeat mode)

#### VCD/SVCD/CD

- RPT ONE (repeat track)
- RPT ALL (repeat disc)
- SHUFFLE (random play)
- RPT SHF (repeat random play)
- RPT OFF (exit repeat mode)

#### MP3/Windows Media™ Audio/DivX®

- RPT ONE (repeat track)
- RPT ALL/FLD (repeat folder)
- SHUFFLE (random play)
- RPT OFF (exit repeat mode)

#### Helpful Hint:

- Repeat playback is not possible on VCDs / SVCDs when the PBC mode is turned on.



## Disc Operations (continued)

### Zooming

This option allows you to zoom and pan through the picture on the TV.

- 1 During playback, press **ZOOM** repeatedly to select a different zoom factor.  
→ Playback continues.
- 2 Use ◀▶▲▼ keys to pan through the enlarged image.
- 3 Press **ZOOM** repeatedly to return to the original size.

### Changing subtitle language

This operation works only on DVDs with multiple subtitle languages. You can change the language you want while playing a DVD.

- Press **SUBTITLE** repeatedly to select different subtitle languages.

### Switching camera angles

This option is only available on DVDs that contain sequences recorded from different camera angles. This allows you to view the picture from different angles.

- 1 During playback, press **INFO**.  
→ Playback information menu appears.
- 2 Press ▼ to highlight 'ANGLE' option in the menu.
- 3 If different camera angles choices are available, press ▶ and use the **numeric keypad 0-9** to select.

### Changing sound track language

This operation works only on DVDs with multiple sound track languages, or VCDs/SVCDs with multiple audio channels.

#### For DVD

- Press **AUDIO SYNC** repeatedly to select the available audio languages.

#### For VCD and SVCD

- Press **AUDIO SYNC** repeatedly to select the available audio channels provided by the disc (STEREO, MONO LEFT, MONO RIGHT or MIX MONO).

### Setting the delay times for audio playback

This feature allows you to adjust the audio delay times if the video playback is slower than the audio output streams, hence resulting in 'Lip-sync'. The only way to correct 'Lip-sync' error caused by delayed video is to delay audio by an equal amount.

- 1 Press and hold **AUDIO SYNC** until 'Audio Sync' appears on the TV.
- 2 Within five seconds, use the **VOL + -** to set the audio output delay times (0 ~ 200 ms).  
→ If the volume control is not used within five seconds, it resumes its normal volume control function.

#### Helpful Hint:

– Set your preferred default **AUDIO SYNC** setting in the setup menu, see 'Setup Menu Options - { Audio Setup > Audio Sync } for details.'

## Disc Operations (continued)

### Playback Control (VCD/SVCD only)

Playback Control (PBC) playback allows you to play VCDs/SVCDs interactively, following the menu on the display. The PBC feature on this unit is turned on by default.

### For VCDs with PBC feature (version 2.0 only) and SVCDs

- During playback (PBC ON mode only), press **MENU (BACK)** to return to PBC menu.

#### Helpful Hint:

– Set your preferred default PBC setting in the setup menu, see ‘Setup Menu Options - { Preferences > PBC } for details.’

### Preview function (VCD/SVCD only)

This function allows you to preview the contents of a VCD/SVCD.

- 1 Press **DISC**.

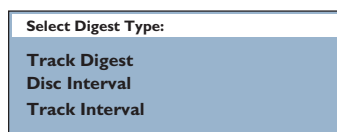

- 2 Use **▲▼** keys to select one of the following options and press **OK**.

#### { Track Digest }

View six different tracks on one screen each time. It allows you to have a quick glance at all the tracks on the disc.

#### { Disc Interval }

View the whole disc in six thumbnail pictures. It divides a disc into six portions at regular intervals and displays them on one screen.

#### { Track Interval }

View the content of a single track in six thumbnail pictures. It divides a single track into six portions at regular intervals and displays them on one screen. This option is only available during playback mode.

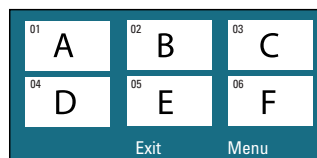

- To go to the previous or next page, press **◀ / ▶**.
  - To return to the main menu, select { **Menu** } on the screen and press **OK**.
  - Press **OK** on the selected thumbnail picture to start playback from there.
- 3 To exit the preview menu, select { **Exit** } on the screen and press **OK**.

## Disc Operations (continued)

### Playing a MP3/WMA disc

This unit can playback most of the MP3 and Windows Media™ Audio files recorded on a recordable disc or commercial CD.

#### Before you start ...

Turn on your TV to the correct Video In channel. See 'Finding the correct viewing channel' for details.

- 1 Load a MP3/WMA disc.
  - The disc reading time may exceed 30 seconds due to the complexity of the directory/file configuration.
  - The disc menu appears on the TV.

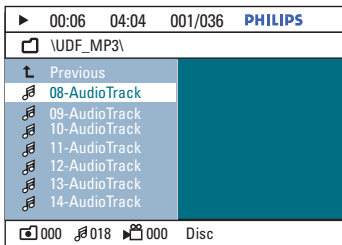

- 2 If the disc main menu contains various folders, use ▲▼ keys to select a desired folder and press **OK** to open the folder.
- 3 Use ▲▼ keys to select a file and press **OK** to start playback.
  - Playback starts from the selected file and continue till the end of the folder.

During playback;

- Press ◀ / ▶ to playback another file in the current folder.
- Press ◀◀ / ▶▶ to fast reverse/forward search for a track.
- To select another folder from the current disc, press ▲ repeatedly to highlight 'Previous' folder and press **OK** to return to the root menu.
- 4 To stop playback, press ■.

#### Helpful Hints:

- You can set to display or skip the folders when you load a MP3/JPEG disc. Press **OPTIONS**, then go to { Preferences > MP3/JPEG NAV }.
- Only the first session of a multi-session CD will be played back.
- It is normal to experience an occasional 'skip' while listening to your MP3/WMA disc due to poor clarity of digital contents during internet downloading.
- If any special characters are present in the MP3/WMA track name (ID3) or album name, it might not be displayed correctly on the screen because this unit does not support the characters.

## Disc Operations (continued)

### Playing a JPEG image file (slide show)

#### Before you start ...

Turn on your TV to the correct Video In channel. See 'Finding the correct viewing channel' for details.

- 1 Load a JPEG photo CD (or Kodak Picture CD).
  - For a Kodak disc, the slide show begins automatically.
  - For a JPEG disc, the picture menu appears on the TV. Press **▶||** to start the slide-show playback.

#### Helpful Hint:

– It may require longer time to display the disc content due to the large number of songs/pictures compiled into the disc.

#### Supported file format:

- The file extension has to be '\*.JPG' and not '\*.JPEG'.
- This unit can only display digital camera pictures according to the JPEG-EXIF format, typically used by almost all digital cameras. It cannot display progressive JPEG, Motion JPEG, or pictures in formats other than JPEG, or sound clips associated with pictures.

#### Preview function

- 1 During playback, press **INFO**.
  - 12 thumbnail pictures will be displayed on the TV.

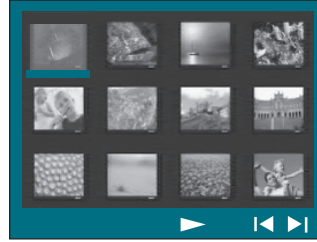

- 2 Press **◀ / ▶** to display the other pictures on the previous/next page.
- 3 Use **◀▶▲▼** keys to select one of the pictures and press **OK** to start playback.
- 4 Press **MENU (BACK)** to return to Picture CD menu.

#### Zooming

- 1 During playback, press **ZOOM** repeatedly to select a different zoom factor.
- 2 Use **◀▶▲▼** keys to pan through the enlarged image.

#### Skip/Rotate picture

- During playback, use **◀▶▲▼** keys to skip/rotate the picture on the TV.

Action	Remote Control
Skip to previous picture.	◀
Skip to next picture.	▶
Rotate the picture clockwise.	▲
Rotate the picture anti-clockwise.	▼

## Disc Operations (continued)

### Playing music and photo files simultaneously

You can create a musical slide show playback if the disc contains both the MP3/WMA music and JPEG picture files.

- ① Load a disc that contains both MP3/WMA and JPEG files.
- ② Use ▲▼ keys to select a MP3/WMA file from the disc menu and press **OK** to start playback.
- ③ During MP3/WMA playback, use ◀▶▲▼ keys to select a JPEG file from the disc menu and press **OK**.  
→ Slideshow begins and continues till the end of the photo folder or album.
- To return to the menu, press **MENU (BACK)**,
- ④ To stop simultaneous playback, press ■ twice.

### Playing a DivX® disc

You can only play those DivX® videos that were rented or purchased using the DivX® registration code of this unit (see 'Setup Menu Options - { General Setup > DivX(R) VOD Code }' for details.)

- ① Load a DivX® disc.
- ② Use ◀▶▲▼ keys to navigate to the file you want to play.
- ③ Press **OK** to start playback.

During playback;

- If the DivX® disc has multilingual subtitles, you can press **SUBTITLE** on the remote control to change the subtitle language.
- If the DivX® title has different audio tracks, you can press **AUDIO SYNC** on the remote control to change the audio stream.
- Use ◀◀ / ▶▶ keys on the remote control to perform fast reverse/forward search.
- Press **INFO** repeatedly until the Time Search menu appears, key in the time where playback should start.  
→ Playback skips to the time entered.

#### Helpful Hints:

- Subtitle files with the following file name extensions (.srt, .smi, .sub, .ssa, .ass) are supported but do not appear on the file navigation menu.
- The subtitle file name has to be the same as the file name of the movie.
- The subtitle can only be displayed up to an average of 45 characters.



# Setup Menu Options

## Accessing the setup menu

You can change the settings in this unit to suit your particular requirements.

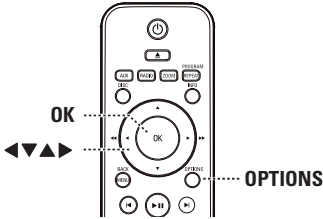

- 1 In disc mode, press **OPTIONS** on the remote control.  
→ The setup menu appears.
- 2 Use **▲ ▼** keys to select one of the setup menu options, then press **▶**.

	General Setup
	Audio Setup
	Video Setup
	Preferences

- If you are not able to access the { Preferences }, press **OPTIONS** to exit the menu. Then, press **■** twice before you press the **OPTIONS** again.
- 3 Use **▲▼** keys to select an option and press **▶**.
  - 4 Select the setting you wish to change and press **OK** to confirm and go back to the previously selected item.  
→ Instructions and explanations of the options are provided in the following pages.  
→ If the option in the menu is grayed out, that means the setting is not available or cannot be changed in the current state.
  - 5 To exit, press **OPTIONS**.

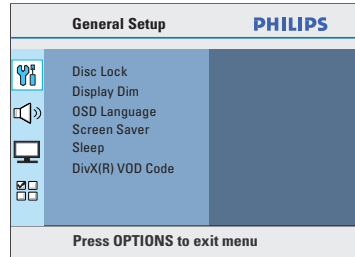

See 'General Setup' on this Chapter.

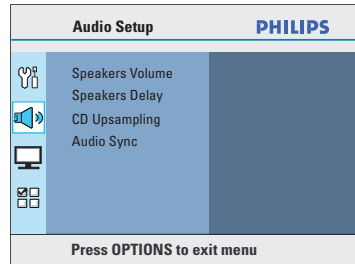

See 'Audio Setup' on this Chapter.

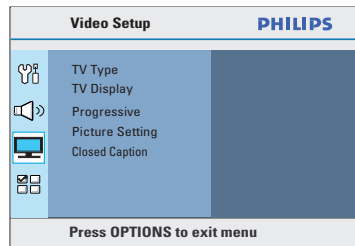

See 'Video Setup' on this Chapter.

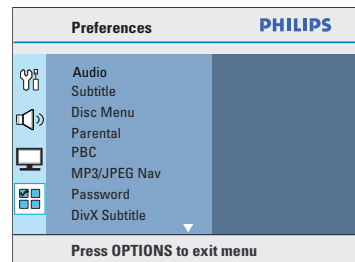

See 'Preferences' on this Chapter.

## Setup Menu Options (continued)

### **General Setup** (underlined options are the factory default settings)

#### **Disc Lock**

Not all discs are rated or coded by the disc maker. You can prevent play of specific discs with the disc lock function. Up to 40 discs can be locked.

- { **Lock** } – To block the playback of the current disc. Subsequent access to a locked disc requires a six-digit password. The default password is '136900' (see { Preferences > Password } for details).
- { **Unlock** } – All discs can be played.

#### **Display Dim**

Select the brightness of this unit's display panel.

- { **100%** } – Full brightness.
- { **70%** } – Medium brightness.
- { **40%** } – Dimmest display. This switches off all LEDs and icons on the front display panel of this unit.

#### **OSD Language**

Select the menu language for this unit's on-screen display.

#### **Screen Saver**

The screen saver prevents damage to the TV screen by avoiding exposure to a static image for too long.

- { **On** } – Switch to TV screen saver mode when playback has been stopped or paused for about 5 minutes.
- { **Off** } – Disable the screen saver function.

#### **Sleep**

The sleep timer enables the unit to switch to standby mode automatically after a preset time.

- { **15/30/45/60 mins** } – Select the preset minutes for switching the unit to standby mode automatically.
- { **Off** } – Turn off the sleep mode function.

#### **DivX(R) VOD Code**

Philips provides you with the DivX® VOD (Video On Demand) registration code that allows you to rent or purchase videos from DivX® VOD service at [www.divx.com/vod](http://www.divx.com/vod). All the downloaded videos from DivX® VOD can only be played back on this unit.

Press ► to see the registration code and press **OK** to exit.

## Setup Menu Options (continued)

### Audio Setup (underlined options are the factory default settings)

#### Speakers Volume

Access the speaker's level setup menu. Use ◀ ▶ keys to adjust the volume level for each connected speaker between -6dB to +6dB. See 'Getting Started - Setting the speakers' channels'.

#### Speakers Delay

Access the speaker's distance setup menu. Use ◀ ▶ keys to set the delay times for the center and rear speakers based on the listening position and distance. See 'Getting Started - Setting the speakers' channels'.

**Note:** 1 ms increase/decrease of delay time is equivalent to one (1) foot change in distance. Use the longer delay time settings when the rear speakers are closer to the listener than the front speakers.

#### CD Upsampling

This feature enables you to convert the music CD to a higher sampling rate using sophisticated digital signal processing for better sound quality.

- { Off } – Turn off CD-upsampling.
- { **88.2 kHz (X2)** } – To convert the sampling rate of the CDs twice as high as the original rate.

**Notes:**

- This function is not available if you switches to Multi-channel mode.
- If you press **SURROUND** on the remote control, it turns off the CD upsampling feature.

#### Audio Sync

This feature allows you to adjust the audio delay times if the video playback is slower than the audio output streams.

Use ◀ ▶ keys to set the delay times for the audio output between 0~200ms.

## Setup Menu Options (continued)

### Video Setup (underlined options are the factory default settings)



#### TV Type

Select the color system that matches the connected TV. It enables playback of a different type of disc (NTSC or Multi disc) on this unit.

- { **NTSC** } – For NTSC-system TV.
- { **Multi** } – For TV that is compatible with both PAL and NTSC.

#### TV Display

The picture shape can be adjusted to fit your TV.

- { **4:3 Pan Scan** } – For a full-height picture with the sides trimmed. 
- { **4:3 Letter Box** } – For a 'wide-screen' display with black bars on the top and bottom. 
- { **16:9 Wide Screen** } – For wide-screen TV (frame ratio 16:9). 

#### Progressive

Before enabling the progressive scan feature, you must ensure that your TV can accept progressive signals (a progressive scan TV is required) and that you have connected this unit to your TV using the Y Pb Pr. See 'Getting Started > Setting up Progressive Scan feature' for details.

- { **Off** } – Turn off the progressive scan mode.
  - { **On** } – Turn on progressive scan mode.
- Read the instructions on the TV and confirm your action by pressing **OK** on the remote control.

#### Picture Setting

This unit provides three predefined sets of picture color settings and one personal setting which you can define yourself.

- { **Standard** } – Original color setting.
- { **Bright** } – Vibrant color setting.
- { **Soft** } – Warm color setting.
- { **Personal** } – Select this to personalize the picture color setting. Use ◀▶ keys to adjust to the setting that best suits your personal preference and press **OK** to confirm. For an average setting, select { 0 }.

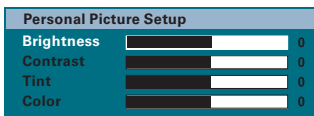

## Setup Menu Options (continued)

---

---

### **Video Setup** (underlined options are the factory default settings)

---

---

#### **Closed Caption**

This feature is only available if the disc contains of special video signal data. It shows sound effects on the screen if your TV supports this feature, such as 'phone ringing' and 'footsteps.'

- { **On** }      – Turn on closed caption feature.
- { **Off** }      – Turn off closed caption feature.

## Setup Menu Options (continued)

### Preferences (underlined options are the factory default settings)

#### Audio

Select the preferred audio language for DVDs with multiple sound tracks.

#### Subtitle

Select the preferred subtitle language for DVD playback.

#### Disc Menu

Select the preferred disc menu language for DVD playback.

**Note:** If the selected audio/subtitle/disc menu language is not available on the DVD, the disc's default language will be used instead.

#### Parental

This is to prohibit viewing of discs that had exceeded the limits you set. It works only on the DVDs with parental level assigned to the complete disc or to certain scenes on the disc.

- 1) Use **▲▼** keys to select a rating level from 1 to 8 and press **OK**.
- 2) Use the **numeric keypad 0-9** on the remote control to enter your six-digit password.

**Notes:**

- The ratings are country-dependent ('1' is considered material that is least offensive and '8' is most offensive). To disable parental controls and allow all discs to play, select '8'.
- Some DVDs are not encoded with a rating though the movie rating may be printed on the disc cover. The rating level feature does not prohibit playback of such discs. VCD, SVCD and CD have no level indication, so parental control has no effect on these type of discs.
- DVDs that are rated higher than the level you selected will not be played unless you enter the same six-digit password.

#### PBC

Play Back Control feature is applicable for VCD/SVCD only. It allows you to play Video CDs (2.0) interactively, following the menu on the display.

- { **On** } – The index menu (if available) appears on the TV when you load a VCD/SVCD.
- { **Off** } – The VCD/SVCD skips the index menu and playback directly from the beginning.

## Setup Menu Options (continued)

### Preferences (underlined options are the factory default settings)

#### MP3/JPEG Nav

MP3/JPEG Navigator can only be set if the disc is recorded with a menu. It allows you to select different display menus for easy navigation.

- { **Without Menu** } – Display all the files contained in the MP3/Picture disc.
- { **With Menu** } – Display the folder menu of the MP3/Picture disc.

**Note:** This unit can only display 648 files in the directory.

#### Password

The password is used for the Disc Lock and Parental. The default password is '136900'. To change the password:

- 1) Press **OK** to access the change password menu.

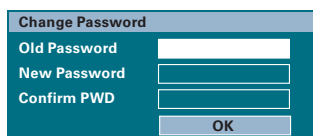

Change Password	
Old Password	<input type="text"/>
New Password	<input type="text"/>
Confirm PWD	<input type="text"/>
<input type="button" value="OK"/>	

- 2) Use the **numeric keypad 0-9** on the remote control to enter your existing six-digit password at { Old Password }.

**Note:** When doing this for the first time or if you forget your existing password, key in '136900'.

- 3) Enter the new six-digit password at { New Password }.
- 4) Enter the new six-digit password again at { Confirm PWD }.
- 5) Press **OK** to confirm and exit the menu.

#### DivX Subtitle

Select the font type that supports the recorded DivX® subtitle.

- { **Standard** } – Display a standard list of Roman subtitle fonts provided by this unit.
- { **Central Europe** } – Display Central Europe fonts.
- { **Cyrillic** } – Display Cyrillic fonts.
- { **Greek** } – Display Greek subtitle fonts.

## Setup Menu Options (continued)

---

---

### **Preferences** (underlined options are the factory default settings)

---

---

#### **Default**

This feature enables you to reset all the setup menu options and your personal settings to the factory defaults, except your password for the Disc Lock and Parental.

Press **OK** to confirm the default reset.

#### **Version Info**

This shows you informations about the current version of the software installed in this unit. You may require this information for future online firmware upgrade.

Press **OK** to display the software version of this unit.



# Radio Operations

## Before you start .....

Ensure that FM antenna is connected to the main unit. (For some models, it has been connected in the factory.) Extend the FM antenna and fix its ends to the wall.

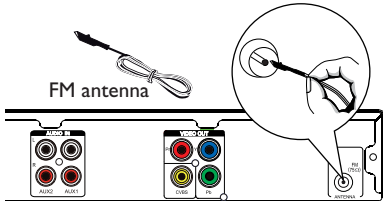

### Helpful Hints:

- For better FM stereo reception, connect an external FM antenna (not supplied.)
- Position the antenna as far away as possible from your TV, VCR or other radiation source to prevent any unwanted interference.

## Tuning to radio stations

- 1 Press **SOURCE** repeatedly until 'FM' appears on the display panel (or press **RADIO** on the remote control).
- 2 Press ◀ / ▶ on the remote control to start tuning.  
→ The frequency indication starts to change until a radio station with sufficient signal strength is found.
- 3 Repeat step 2 if necessary until you find the desired radio station
- 4 To fine-tune the reception of a weak station, press ▲ / ▼ briefly and repeatedly until an optimal reception is found.

## Presetting radio stations

You can store up to 40 FM preset radio stations in the memory. There are three different ways to program the radio stations:

- Using auto install (for first time setup only)
- Using automatic preset
- Using manual preset

### Helpful Hints:

- This unit exits presetting mode if no button is pressed within 20 seconds.
- If no stereo signal is detected or less than 5 (five) stations are detected during radio installation, 'CHECK ANTENNA' appears.

## Using auto install

When you access the 'RADIO' mode for the very first time, you will be prompted to install the radio stations. With this feature, you can install all the available radio station automatically with one touch of button.

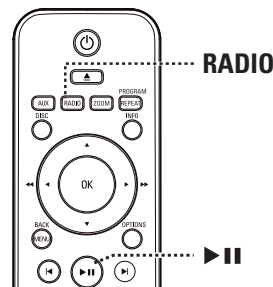

- 1 Press **RADIO**.  
→ 'AUTO INSTALL ... PRESS PLAY' appears.
- 2 Press **▶ II**.  
→ All the available radio stations with strong signal will be stored automatically.  
→ Once complete, the first tuned radio station will be played back.

## Radio Operations (continued)

### Using automatic preset

Use automatic presetting to store or reinstall all the preset radio stations.

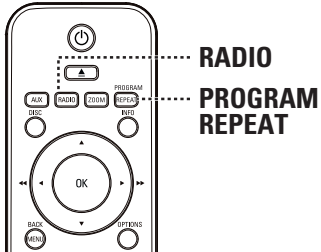

- 1 Press **RADIO** to select 'FM' band.
- 2 Press and hold **REPEAT (PROGRAM)** until 'START ...' appears on the display panel.  
→ All previously stored radio stations will be replaced.

### Using manual preset

Use manual presetting to store your favourite radio stations.

- 1 Tune to your desired radio station (see 'Tuning to radio stations').
- 2 Press **REPEAT (PROGRAM)**.
- 3 Press **◀ / ▶** or use the **numeric keypad 0-9** to select a preset number that you want to store the current radio station.
- 4 Press **REPEAT (PROGRAM)** to store.

### Selecting a preset radio station

- 1 Press **RADIO** to select 'FM' band.
- 2 Press **◀ / ▶** or use the **numeric keypad 0-9** to select a preset radio stations.  
→ The preset number and radio frequency appear on the display panel.

### Deleting a preset radio station

- 1 In radio mode, press **◀ / ▶** to select a preset radio station.
- 2 Press and hold **■** until 'FM X DELETED' appears.  
→ 'X' is the preset number.  
→ The radio station continues to play but has been deleted from the preset list.  
→ The rest of the preset radio stations remain unchanged.

# Sound and Volume Controls

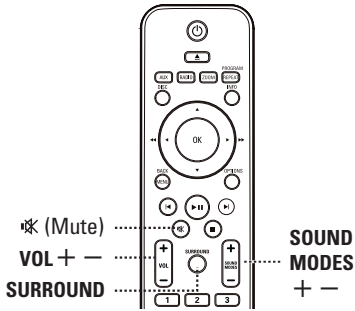

## Volume control

- Press **VOL + / -** to increase or decrease the volume level.

### To turn off the volume temporarily

- Press **MUTE**.
  - Playback continues without sound and 'MUTE' appears.
  - To restore the volume, press **MUTE** again, or increase the volume level.

## Selecting surround sound

- Press **SURROUND** to select Multi-Channel, Stereo sound or Party sound.
  - The availability of the various surround sound modes depends on the sound available on the disc.
  - The available output modes for Multi-channel include: Dolby Digital and Dolby Pro Logic II.
  - Stereo broadcasts or recordings will produce some surround channel effects when played in a surround mode.
  - Party mode is ideal for party music. It enhanced the stereo channels output by duplicating the sound output to the center, rear left and rear right speakers.

## Selecting digital sound effects

Select a preset digital sound effect that matches your disc's content or that optimizes the sound of the musical style you are playing.

- Press **SOUND MODES + / -** to select the available sound effect.

Movies	Music	Description
CONCERT	CLASSIC	Flat and pure sound mode. Ideal for listening to classical music and watching live concert DVDs.
DRAMA	LOUNGE	Moderate sound mode suitable for lounge music and watching dramas.
ACTION	ROCK	Enhanced low and high range for great sounding movie effects and atmosphere. Great for action movies and rock/pop music.
GAMING	SPORTS	Moderate mid range and surround effects for clear vocals and the atmosphere of a live sports venue. Also suitable for video gaming.
NIGHT	NIGHT	Dynamically controlled sound mode suitable for watching movies at night or for non-intrusive background music.

## Other Features

### Installing the latest software

Philips provides software upgrades to make sure that this unit is compatible with the newest formats. To check the updates, compare the current software version of this unit with the latest software version available at the Philips website.

- 1 Press **OPTIONS** to select { **Preferences** } menu.
- 2 Select { **Version Info** }, and press **OK** to check the software version of this unit.

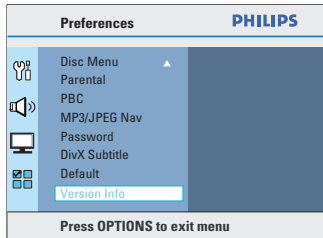

- 3 Write down the version number, then press **OPTIONS** to exit the menu.
- 4 Go to [www.philips.com/support](http://www.philips.com/support) to check the latest software version available for this unit.
- 5 If the latest software version is higher than the software version of this unit, download it and store onto a CD-R.
- 6 Insert the CD-R to this unit and confirm upgrade operation.

**Note:**

**Never unplug or turn off this unit during the upgrade.**

- 7 Once complete, this unit turns off to standby mode automatically.

# Troubleshooting

## WARNING

Under no circumstances should you try to repair the system yourself, as this will invalidate the warranty. Never open the system as there is a risk of electric shock.

If a fault occurs, first check the points listed below before taking the system for repair. If you are unable to solve a problem by following these instructions, consult your dealer or Philips for help.

Problem (General)	Solution
<b>No picture.</b>	<ul style="list-style-type: none"><li>– Refer to your TV's manual for correct Video In channel selection. Change the TV channel until you see the DVD screen.</li><li>– Press DISC to select disc mode.</li><li>– If this happens when you turn on the progressive scan feature, wait for 15 seconds for the auto recover or switch to the default mode as below:<ol style="list-style-type: none"><li>1) Press <b>▲</b> to open the disc tray.</li><li>2) Press <b>◀</b> on the remote control.</li><li>3) Press <b>AUDIO SYNC</b> on the remote control.</li></ol></li></ul>
<b>Completely distorted picture or black/white picture.</b>	<ul style="list-style-type: none"><li>– Check the video connection.</li><li>– Sometimes a small amount of picture distortion may appear. This is not a malfunction.</li><li>– The disc is dirty. Clean the disc.</li></ul>
<b>No sound or distorted sound.</b>	<ul style="list-style-type: none"><li>– Adjust the volume.</li><li>– Check the speaker connections and settings.</li><li>– Make sure that the audio cables are connected and press the correct source button (for example, AUX) to choose the device that you want to hear through this unit.</li></ul>
<b>No surround sound effect from the speakers.</b>	<ul style="list-style-type: none"><li>– Press SURROUND to select a correct surround sound setting.</li><li>– For playback of DTS track, press AUDIO SYNC to select other audio track.</li><li>– Make sure that the source you are playing is recorded or broadcast in surround sound (Dolby Digital, etc).</li></ul>
<b>The remote control does not function properly.</b>	<ul style="list-style-type: none"><li>– Select the source you want to play (for example, DISC or RADIO) before pressing the function button (<b>▶  </b>, <b>◀ / ▶</b>).</li><li>– Reduce the distance between the remote control and this unit.</li><li>– Batteries are weak, replace the batteries.</li><li>– Point the remote control directly toward the IR sensor.</li></ul>

## Troubleshooting (continued)

Problem (Playback)	Solution
<b>The unit does not start playback.</b>	<ul style="list-style-type: none"><li>- Load a readable disc with the playback side facing down. The DVD+R/CD-R must be finalized.</li><li>- Make sure the disc is not scratched or warped.</li><li>- Press <b>OPTIONS</b> to turn off the system setup menu screen.</li><li>- You may need to enter the password in order to unlock the disc for playback.</li><li>- Moisture may have condensed inside this unit. Remove the disc and leave this unit turned on for about an hour.</li></ul>
<b>The aspect ratio of the screen cannot be changed even though you have set the TV display.</b>	<ul style="list-style-type: none"><li>- The aspect ratio is fixed on the DVD disc.</li><li>- Depending on the TV, it may not be possible to change the aspect ratio.</li></ul>
<b>Cannot activate some features e.g. Angles, Subtitles, or multi-language Audio.</b>	<ul style="list-style-type: none"><li>- The features may not be available on the DVD.</li><li>- Changing the language for the sound or subtitle is prohibited on this DVD.</li></ul>
<b>Not able to select some items in the setup/system menu.</b>	<ul style="list-style-type: none"><li>- Press <b>■</b> twice before selecting the system setup menu.</li><li>- Depending on the disc availability, some menu items cannot be selected.</li></ul>
<b>Unable to play DivX® movies.</b>	<ul style="list-style-type: none"><li>- Ensure that the DivX® file is encoded according to the 'Home Theater Profile' with the DivX® encoder.</li><li>- Check that the DivX® movie download is a complete file.</li></ul>
<b>Radio reception is poor.</b>	<ul style="list-style-type: none"><li>- If the signal is too weak, adjust the antenna or connect an external antenna for better reception.</li><li>- Increase the distance between this unit and your TV or VCR.</li><li>- Tune in to the correct frequency.</li><li>- Place the antenna further away from any equipment that may be causing the interference.</li></ul>

# Specifications

## AMPLIFIER

Total output power:  
- Home Theater mode: 200W  
- FTC\* output power: 120W  
Frequency Response: 180 Hz – 18 kHz /  $\pm 3$  dB  
Signal-to-Noise Ratio: > 60 dB (A-weighted)  
Input Sensitivity  
- AUX 1: 400 mV  
- AUX 2: 400 mV

\* (1% THD 1kHz)

## RADIO

Tuning Range: FM 87.5-108 MHz  
(100 kHz)  
26 dB Quieting  
Sensitivity: FM 22 dBf  
IF Rejection Ratio: FM 60 dB  
Signal-to-Noise Ratio: FM 50 dB  
Harmonic Distortion: FM Mono 3%  
FM Stereo 3%  
Frequency Response FM 180 Hz–10 kHz /  $\pm 6$  dB  
Stereo Separation FM 26 dB (1 kHz)  
Stereo Threshold FM 29 dB

## DISC

Laser Type Semiconductor  
Disc Diametre 12cm / 8cm  
Video Decoding MPEG-1 / MPEG-2 /  
/ DivX 3/4/5/6, Ultra  
Video DAC 12 Bits  
Signal System PAL / NTSC  
Video Format 4:3 / 16:9  
Video S/N 56 dB  
Composite Video  
Output 1.0 V<sub>p-p</sub>, 75 $\Omega$   
Frequency Response 4 Hz–20 kHz (44.1 kHz)  
4 Hz–22 kHz (48 kHz)  
4 Hz–44 kHz (96 kHz)  
PCM IEC 60958  
Dolby Digital IEC 60958, IEC 61937

## MAIN UNIT

Power Supply Rating: 120 V; 60 Hz  
Power Consumption: 40 W  
Dimensions: 460 x 55 x 332 (mm)  
(w x h x d)  
Weight: 2.58 kg

## FRONT AND REAR SPEAKERS

System: Full range satellite  
Impedance: 4  $\Omega$   
Speaker drivers: 3" full range speaker  
Frequency response: 150 Hz – 20 kHz  
Dimensions: 100 x 95.5 x 83.5 (mm)  
(w x h x d)  
Weight: 0.47 kg/each

## CENTRE SPEAKER

System: Full range satellite  
Impedance: 8  $\Omega$   
Speaker drivers: 3" full range speaker  
Frequency response: 150 Hz – 20 kHz  
Dimensions: 100 x 99.5 x 83.5 (mm)  
(w x h x d)  
Weight: 0.52 kg

## SUBWOOFER

Impedance: 8  $\Omega$   
Speaker drivers: 165 mm (6.5") woofer  
Frequency response: 40 Hz – 150 Hz  
Dimensions: 131 x 315.5 x 386 (mm)  
(w x h x d)  
Weight: 3.6 kg

Specifications subject to change without prior notice.

## Glossary

**Analogue audio:** Sound that has not been turned into numbers. Analogue sound is available if you use the AUDIO LEFT/RIGHT. These red and white jacks send audio through two channels, the left and right.

**Aspect ratio:** Aspect ratio refers to the length to height ratio of TV screens. The ratio of a standard TV is 4:3, while the ratio of a high-definition or wide TV is 16:9. The letter box allows you to enjoy a picture with a wider perspective on a standard 4:3 screen.

**AUDIO IN jacks:** Red and white jacks on the back of the unit that receive audio from another system (TV, Stereo, etc.).

**Bit Rate:** The amount of data used to hold a given length of music; measured in kilobits per second, or kbps. Or, the speed at which you record. Generally, the higher the bit rate, or the higher the recording speed, the better the sound quality. However, higher bit rates use more space on a disc.

**Chapter:** Sections of a picture or a music piece on a DVD that are smaller than titles. A title is composed of several chapters. Each chapter is assigned a chapter number enabling you to locate the chapter you want.

**Component video:** Jacks on the back of the unit that send out high-quality video to a TV that has component video input jacks (R/G/B, Y/Pb/Pr, etc.).

**Composite video (CVBS):** A single video signal commonly used in most consumer video products.

**Disc menu:** A screen display prepared for allowing a selection of images, sounds, subtitles, multi-angles, etc., recorded on a DVD.

**DivX®:** The DivX® code is a patent-pending, MPEG-4 based video compression technology, developed by DivX® Networks, Inc., that can shrink digital video to sizes small enough to be transported over the internet, while maintaining high visual quality.

**Dolby Digital:** A surround sound system developed by Dolby Laboratories containing up to six channels of digital audio (front left and right, surround left and right, center and subwoofer).

**Dolby Surround Pro Logic II:** It is an improved matrix decoding technology that provides better spatiality and directionality on Dolby Surround programme material, provides a convincing three dimensional sound field on conventional stereo music recordings and is ideally suited to bring the surround experience to automotive sound. While conventional surround programming is fully compatible with Dolby Surround Pro Logic II decoders, soundtracks will be able to be encoded specifically to take full advantage of Pro Logic II playback, including separate left and right surround channels. (Such material is also compatible with conventional Pro Logic decoders).

**HDCP** (High-bandwidth Digital Content Protection) is a specification that provides a secure transmission of digital contents between different devices (to prevent unauthorized copyright).

**JPEG:** A very common digital still picture format. A still-picture data compression system proposed by the Joint Photographic Expert Group, which features small decrease in image quality in spite of its high compression ratio. Files are recognized by their file extension 'JPG or JPEG'.



**MP3:** A file format with a sound data compression system. 'MP3' is the abbreviation of Motion Picture Experts Group I (or MPEG-I) Audio Layer3. By using the MP3 format, one CD-R or CD-RW can contain about 10 times more data than a regular CD.

**MPEG:** Motion Picture Experts Group. A collection of compression systems for digital audio and video.

**PBC:** Playback Control. A system of navigating a Video CD/Super VCD through on-screen menus recorded onto the disc. You can enjoy interactive playback and searching.

**Progressive Scan:** The progressive scan displays twice the number of frames per second than in an ordinary TV system. It offers higher picture resolution and quality.

**Region code:** A system allowing discs to be played only in the region designated. This unit will only play discs that have compatible region codes. You can find the region code of your unit by looking at the product label. Some discs are compatible with more than one region (or ALL regions).

**Surround:** A system for creating realistic three dimensional sound fields full of realism by arranging multiple speakers around the listener.

**Title:** The longest section of a movie or music feature on DVD. Each title is assigned a title number, enabling you to locate the title you want.

**WMA:** Windows Media™ Audio. Refers to an audio compression technology developed by Microsoft Corporation. WMA data can be encoded by using Windows Media Player version 9 or Windows Media Player for Windows XP. Files are recognized by their file extension 'WMA'.

## PHILIPS LIMITED WARRANTY ONE (1) YEAR

### WARRANTY COVERAGE:

PHILIPS warranty obligation is limited to the terms set forth below.

### WHO IS COVERED:

Philips warrants the product to the original purchaser or the person receiving the product as a gift against defects in materials and workmanship as based on the date of original purchase ("Warranty Period") from an Authorized Dealer. The original sales receipt showing the product name and the purchase date from an authorized retailer is considered such proof.

### WHAT IS COVERED:

The Philips warranty covers new products if a defect in material or workmanship occurs and a valid claim is received by Philips within the Warranty Period. At its option, Philips will either (1) repair the product at no charge, using new or refurbished replacement parts, or (2) exchange the product with a product that is new or which has been manufactured from new, or serviceable used parts and is at least functionally equivalent or most comparable to the original product in Philips current inventory, or (3) refund the original purchase price of the product. Philips warrants replacement products or parts provided under this warranty against defects in materials and workmanship from the date of the replacement or repair for ninety (90) days or for the remaining portion of the original product's warranty, whichever provides longer coverage for you. When a product or part is exchanged, any replacement item becomes your property and the replaced item becomes Philips' property. When a refund is given, your product becomes Philips' property.

**Note: Any product sold and identified as refurbished or renewed carries a ninety (90) day limited warranty.**

**Replacement product can only be sent if all warranty requirements are met. Failure to follow all requirements can result in delay.**

### WHAT IS NOT COVERED - EXCLUSIONS AND LIMITATIONS:

This Limited Warranty applies only to the new products manufactured by or for Philips that can be identified by the trademark, trade name, or logo affixed to it. This Limited Warranty does not apply to any non-Philips hardware product or any software, even if packaged or sold with the product. Non-Philips manufacturers, suppliers, or publishers may provide a separate warranty for their own products packaged with the bundled product.

Philips is not liable for any damage to or loss of any programs, data, or other information stored on any media contained within the product, or any non-Philips product or part not covered by this warranty. Recovery or reinstallation of programs, data or other information is not covered under this Limited Warranty.

This warranty does not apply (a) to damage caused by accident, abuse, misuse, neglect, misapplication, or non-Philips product, (b) to damage caused by service performed by anyone other than Philips or Philips Authorized Service Location, (c) to a product or a part that has been modified without the written permission of

Philips, or (d) if any Philips serial number has been removed or defaced, or (e) product, accessories or consumables sold "AS IS" without warranty of any kind by including refurbished Philips product sold "AS IS" by some retailers.

### This Limited Warranty does not cover:

- Shipping charges to return defective product to Philips.
- Labor charges for installation or setup of the product, adjustment of customer controls on the product, and installation or repair of antenna/signal source systems outside of the product.
- Product repair and/or part replacement because of improper installation or maintenance, connections to improper voltage supply, power line surge, lightning damage, retained images or screen markings resulting from viewing fixed stationary content for extended periods, product cosmetic appearance items due to normal wear and tear, unauthorized repair or other cause not within the control of Philips.
- Damage or claims for products not being available for use, or for lost data or lost software.
- Damage from mishandled shipments or transit accidents when returning product to Philips.
- A product that requires modification or adaptation to enable it to operate in any country other than the country for which it was designed, manufactured, approved and/or authorized, or repair of products damaged by these modifications.
- A product used for commercial or institutional purposes (including but not limited to rental purposes).
- Product lost in shipment and no signature verification receipt can be provided.
- Failure to operate per Owner's Manual.

### TO OBTAIN ASSISTANCE IN THE U.S.A., PUERTO RICO, OR U.S. VIRGIN ISLANDS...

Contact Philips Customer Care Center at:  
1-888-PHILIPS (1-888-744-5477)

### TO OBTAIN ASSISTANCE IN CANADA...

1-800-661-6162 (French Speaking)  
1-888-PHILIPS (1-888-744-5477) - (English or Spanish Speaking)

REPAIR OR REPLACEMENT AS PROVIDED UNDER THIS WARRANTY IS THE EXCLUSIVE REMEDY FOR THE CONSUMER. PHILIPS SHALL NOT BE LIABLE FOR ANY INCIDENTAL OR CONSEQUENTIAL DAMAGES FOR BREACH OF ANY EXPRESS OR IMPLIED WARRANTY ON THIS PRODUCT. EXCEPT TO THE EXTENT PROHIBITED BY APPLICABLE LAW, ANY IMPLIED WARRANTY OF MERCHANTABILITY OR FITNESS FOR A PARTICULAR PURPOSE ON THIS PRODUCT IS LIMITED IN DURATION TO THE DURATION OF THIS WARRANTY.

Some states do not allow the exclusions or limitation of incidental or consequential damages, or allow limitations on how long an implied warranty lasts, so the above limitations or exclusions may not apply to you.

*This warranty gives you specific legal rights. You may have other rights which vary from state/province to state/province.*

Philips, P.O. Box 671539, Marietta, GA. 30006-0026

3121 233 48802

