

Register your product and get support at
www.philips.com/welcome

Immersive
3000 series



Quick start guide

PHILIPS



EN Before using your product, read all accompanying safety information

zh 使用产品前，请阅读所有随附的安全信息

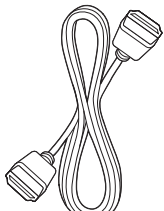

HDMI



MIC-IN Converter

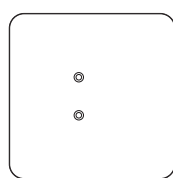
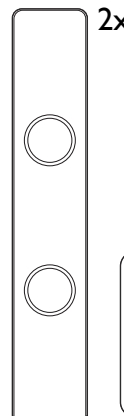
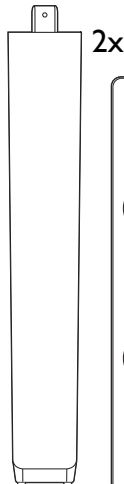
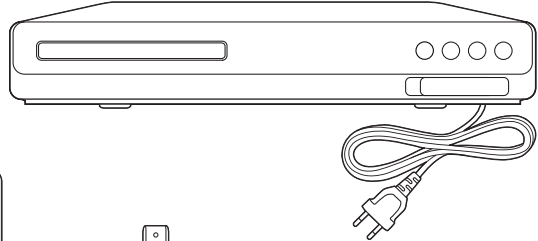
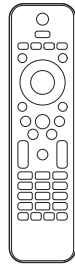
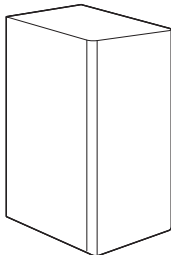
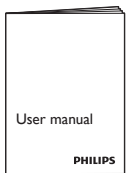

1

EN Stand mount the speakers

ZH 使用扬声器支架

1

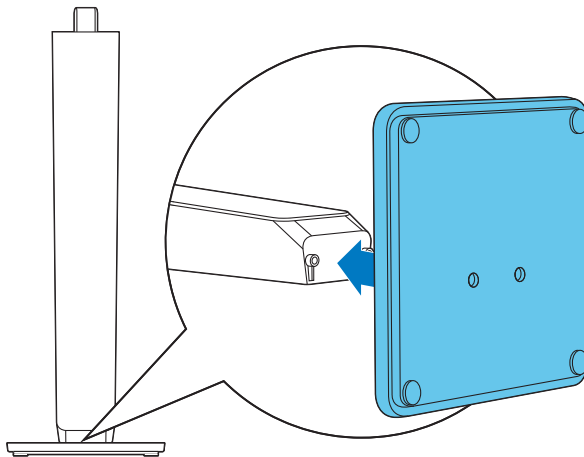

2

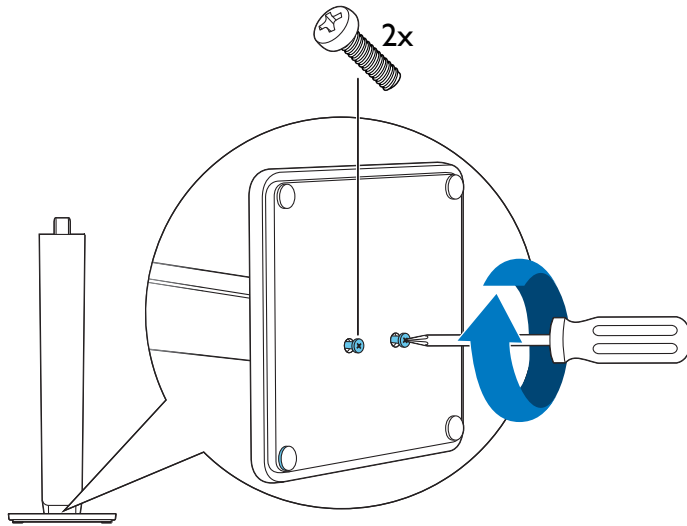

3

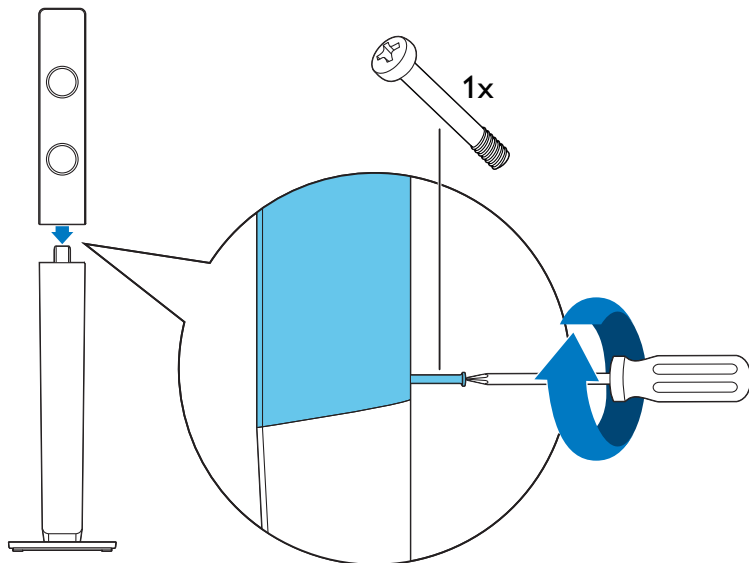

2

EN Connect the home theater

ZH 连接家庭影院

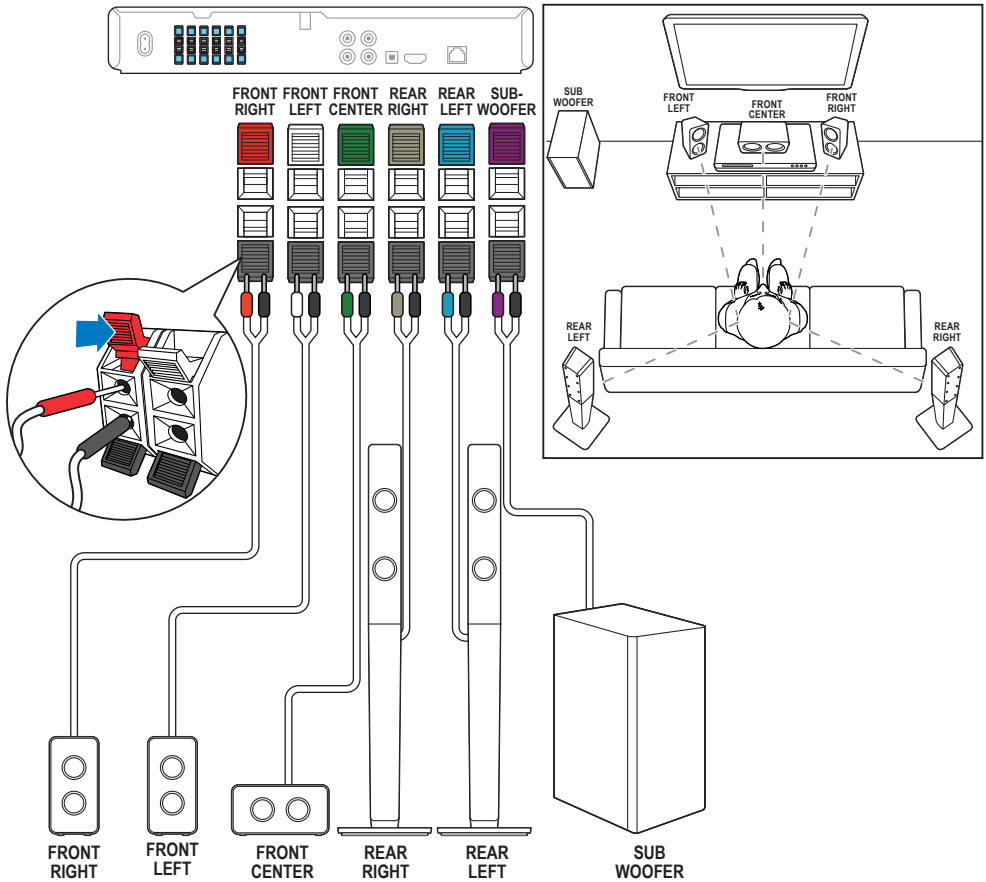

3

EN Connect to TV in one of these ways

ZH 通过这些方式连接至电视

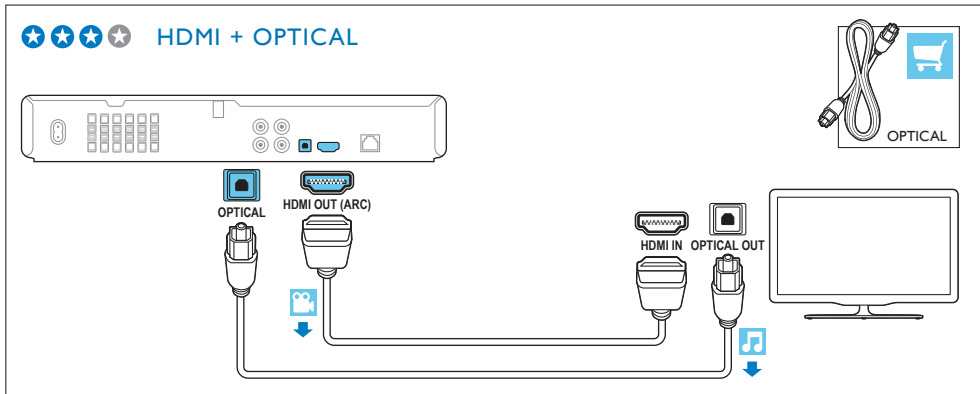
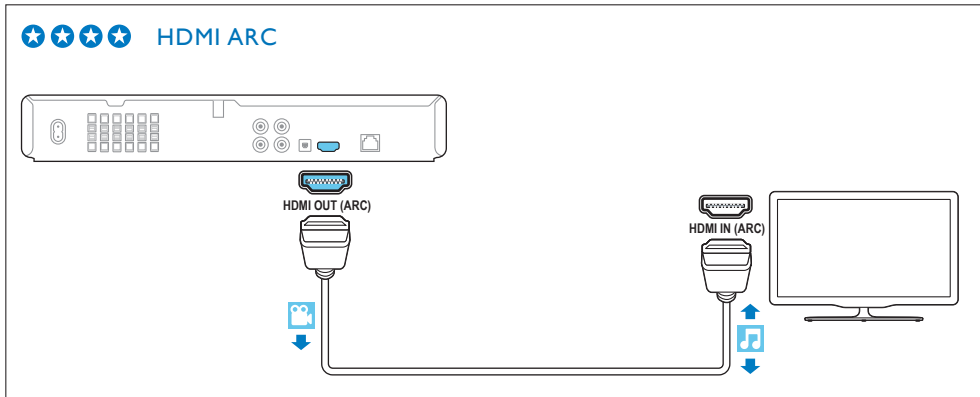

★ ★ ★ ★ HDMI + COAXIAL

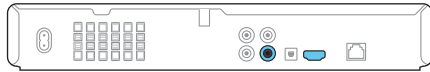

★ ★ ★ ★ HDMI + AUDIO L/R

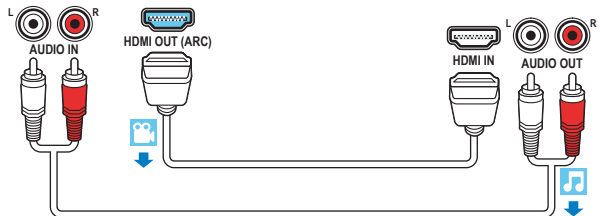
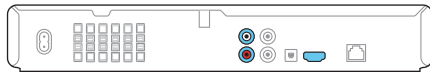

4

EN Switch on the home theater

ZH 打开家庭影院

1

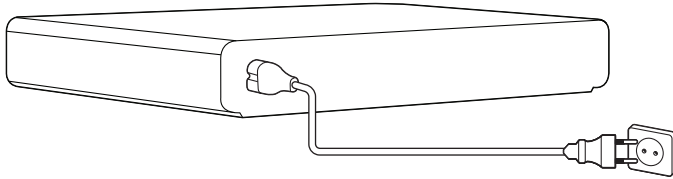

2

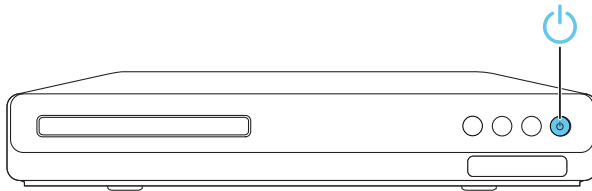

3

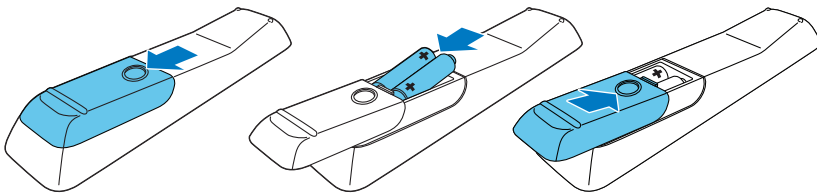

5

EN Complete the first time setup

ZH 完成首次设置

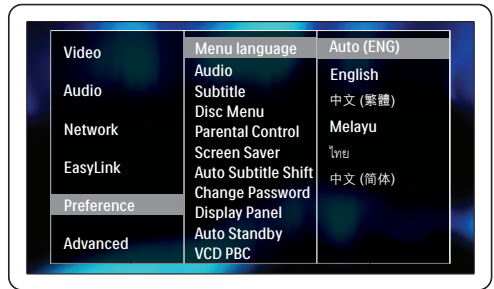
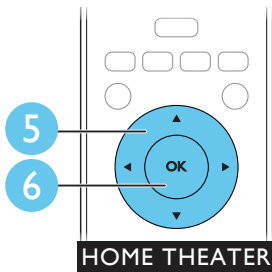
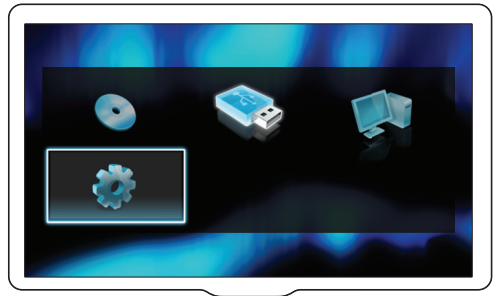
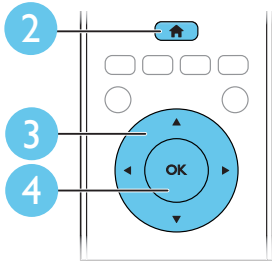
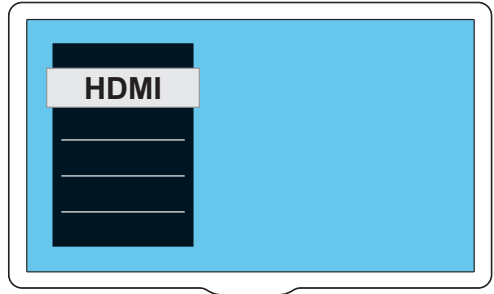
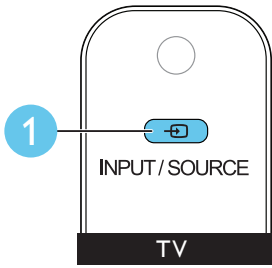

6

EN Use your home theater

ZH 使用家庭影院

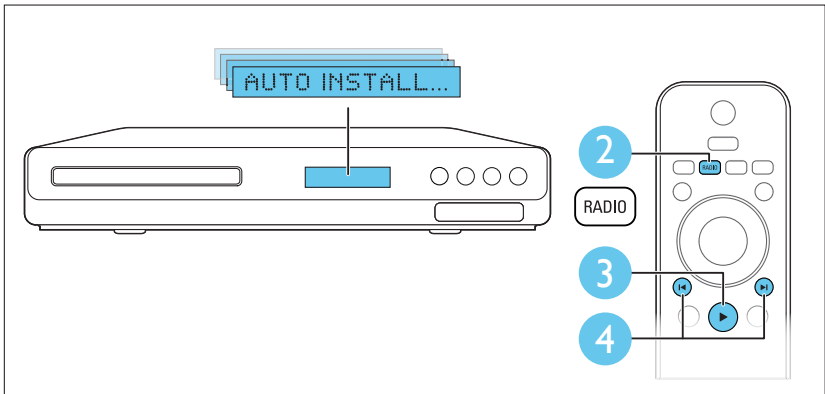
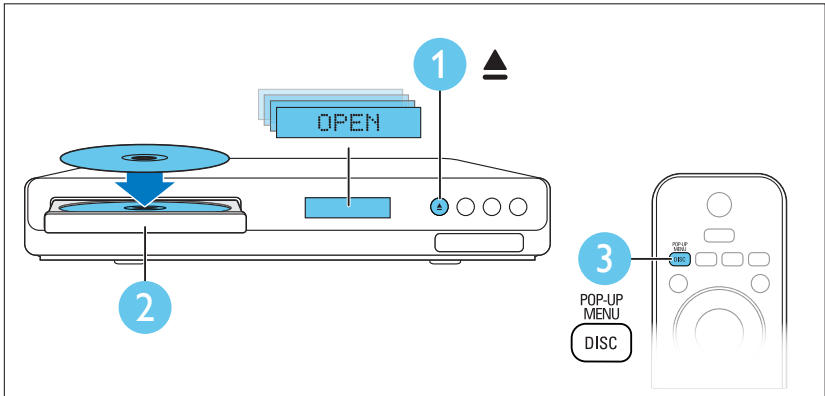

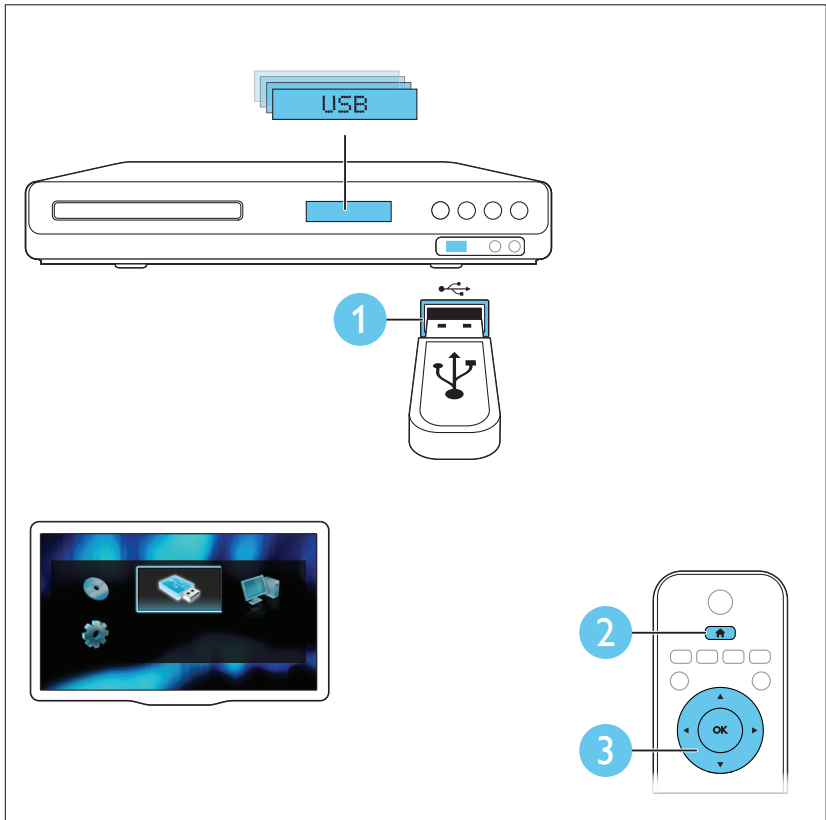
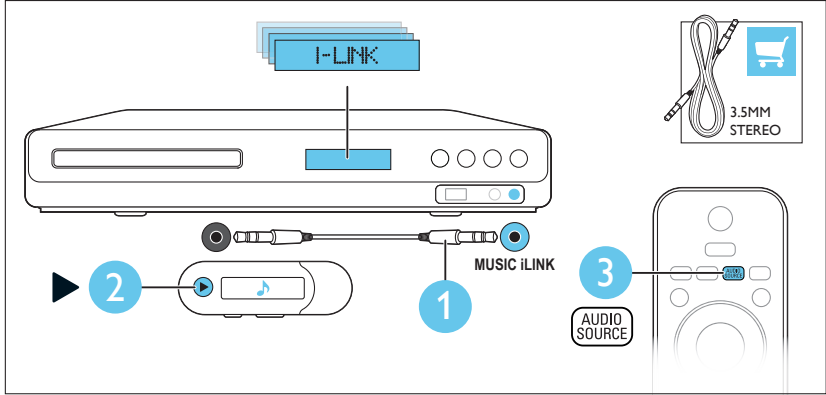

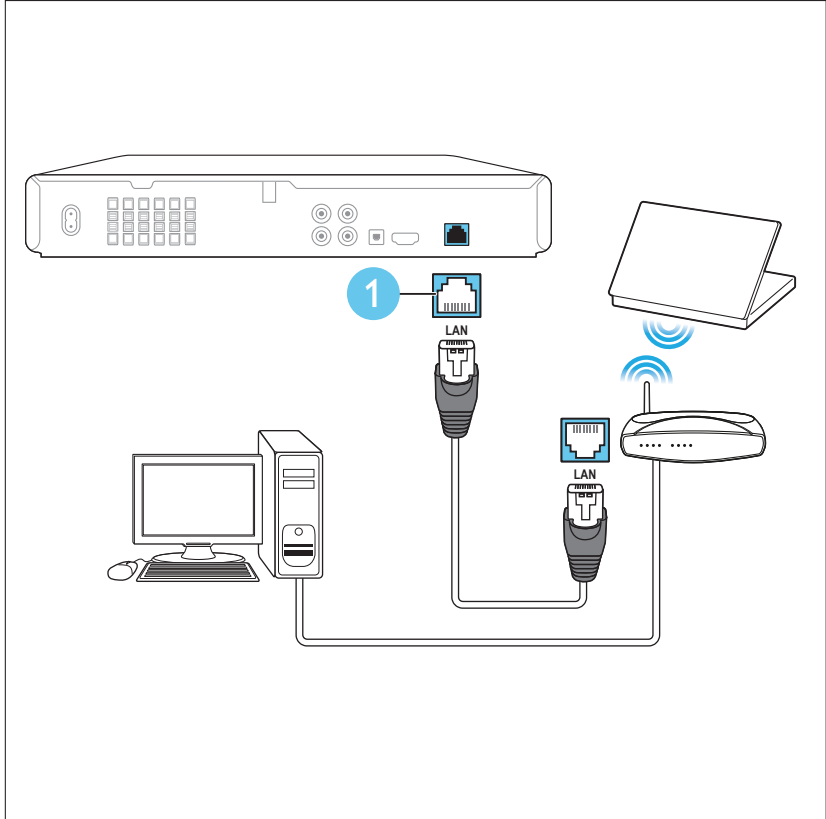



EN For more information about using this product visit
www.philips.com/support

ZH 有关使用本产品的更多信息，
请访问 www.philips.com/support



www.philips.com/support



Non-contractual images. / Images non contractuelles. /
Außervertragliche Bilder.

All registered and unregistered trademarks are property
of their respective owners.

Specifications are subject to change without notice

Trademarks are the property of Koninklijke Philips Electronics
N.V. or their respective owners

2012 © Koninklijke Philips Electronics N.V. All rights reserved

www.philips.com

sgsn_1204/93_v1



Be responsible
Respect copyrights

