

Essence

5000 Series

Rechargeable
sonic toothbrush



PHILIPS
sonicare
the sonic toothbrush

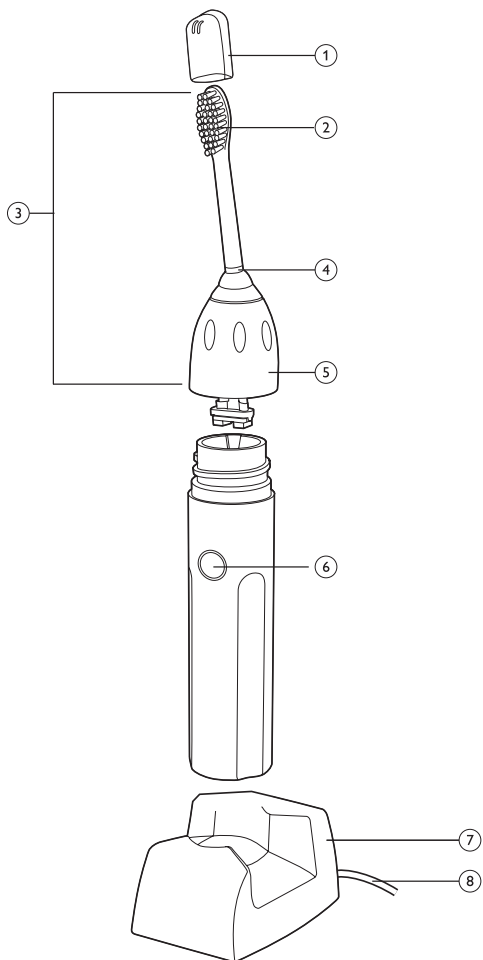

Sonicare Essence

ENGLISH 4

General description (Fig. 1)

- 1 Travel cap
 - 2 Extra soft bristles
 - 3 Brush head
 - 4 Personalized ID ring
 - 5 Removable nut
 - 6 Power on/off button & charge indicator light
 - 7 Charger base with cord wrap
 - 8 Power cord
- **Refer to bottom of charger for voltage specifications.**

IMPORTANT SAFEGUARDS

READ ALL INSTRUCTIONS BEFORE USE**DANGERS**

To reduce the risk of electrocution:

- 1 Do not place or store product where it can fall or be pulled into a tub or sink.
- 2 Do not place in or drop into water or other liquid.
- 3 Do not reach for a product that has fallen into water. Unplug immediately.
- 4 Do not use while bathing.

WARNINGS

To reduce the risk of burns, electrocution, fire or injury to persons:

- 1 **DO NOT** plug into an outlet with a voltage other than specified on the bottom of the charger. Voltage converters **DO NOT** guarantee voltage compatibility.

- 2 Never force the plug into an outlet; if it does not easily fit into the outlet, discontinue use.
- 3 Discontinue use if this product appears damaged in any way (brush head, handle, charger). This product contains no serviceable parts. Refer to chapter 'Guarantee and service' if your Sonicare no longer works properly or needs repair.
- 4 Never use the charger if it has a damaged cord or plug.
- 5 Keep cord away from heated surfaces.
- 6 Do not use the charger outdoors.
- 7 Do not use the charger if dropped into water.
- 8 Avoid using a brush head with crushed or bent bristles. Damaged bristles may break off while brushing. Replace the brush head with a new one every 3 months or sooner if signs of wear appear. Inappropriate cleaning may cause bristle damage. (See chapter 'Cleaning')
- 9 This product is designed to clean your teeth, gums and tongue only. Use this product only for its intended use as described in this booklet. Discontinue use of this product and contact a physician/dentist if discomfort or pain is experienced.
- 10 This appliance is not intended for use by persons (including children) with reduced physical, sensory or mental capabilities, or lack of experience and knowledge, unless they have been given supervision or instruction concerning use of the appliance by a person responsible for their safety.
- 11 Children should be supervised to ensure that they do not play with the appliance.
- 12 Sonicare is a personal care device and is not intended for use on multiple patients in a dental office or institution.

- 13 Do not use attachments and/or brush heads other than those recommended by the manufacturer.
- 14 If your toothpaste includes peroxide, baking soda or other bicarbonate (common in whitening toothpastes), thoroughly clean your brush head and handle with soap and water after each use. Otherwise plastic cracking may occur.
- 15 To avoid damage to the product, do not place the brush head or charger in the dishwasher for cleaning.

MEDICAL WARNINGS

- 1 Consult your dental professional before you use this product if you have had oral or gum surgery in the previous 2 months.
- 2 Contact your dental professional if excessive bleeding occurs after using this product or bleeding continues to occur after 1 week of use.
- 3 If you have a pacemaker or other implanted device contact your physician or the device manufacturer prior to use.
- 4 Sonicare has been tested and is compliant with safety standards for electromagnetic devices.
- 5 Consult your physician prior to using the Sonicare if you have medical concerns.

SAVE THESE INSTRUCTIONS

Preparing for use

Attaching the brush head

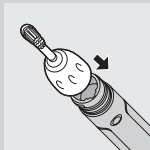

- 1** Align the front of the brush head with the front of the toothbrush handle. Match the bars that are on the inside top of the removable nut with the notches inside the top of the handle and slide the brush head onto the handle.

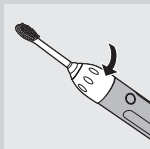

- 2** Screw the brush head nut clockwise until it's firmly tightened. If the brush head rattles when in use, tighten the nut further.

- 3** Remove the travel cap from your brush head when you are ready to brush.

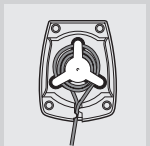

- 4** Use the cord wrap in the bottom of the charger to store excess cord.

Charging your Sonicare

Sonicare comes with the batteries completely discharged and should be charged for at least 24 hours during the first few days of use. It is recommended that you keep your Sonicare in the charger when not in use to maintain a full battery charge. It takes at least 24 hours to fully charge the battery of your Sonicare toothbrush.



- 1 To charge your Sonicare, place the handle in the charger with the power button facing forward. Be sure the bottom of the handle sits back securely in the charger, making complete contact.

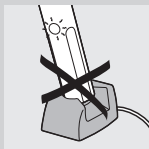

- ▶ When the handle is placed incorrectly in the charger, the charge indicator light may still illuminate, but charging will not take place.

Handles of other Sonicare models do not fit in this charger and will therefore not charge effectively. Do not attempt to force a handle into this charger as this will cause damage.

Using the appliance

Useful tips

- ▶ Place the brush head in your mouth before turning on your Sonicare and keep your mouth closed during brushing, otherwise toothpaste may splatter.
- ▶ You may experience a slight tickling or tingling sensation when using an electronic toothbrush such as Sonicare for the first time. As you become accustomed to brushing with Sonicare this sensitivity will diminish.
- ▶ A fully charged Sonicare will provide approximately 2 weeks of typical use (2 minutes of brushing twice a day), making it easy to travel without the charger.

Remember that voltage converters and plug adapters DO NOT guarantee voltage compatibility. Always check for voltage compatibility.

Brushing technique

Follow these simple steps to maximize your brushing experience.

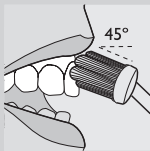

- 1** Before turning the Sonicare on, place the bristles of the brush head on your gumline at a 45-degree angle.
- 2** Hold the handle with a light grip, turn the Sonicare on, and gently move the bristles in a small circular motion so the longer bristles reach between your teeth. After a few seconds, glide the bristles to the next section. Continue this routine throughout your 2-minute brushing cycle.
- 3** To maximize the effectiveness of your Sonicare toothbrush, use light pressure and let the Sonicare toothbrush do the brushing for you. Do not scrub.



- 4** To make sure you brush evenly throughout the mouth, divide your mouth into 4 sections: outside top, inside top, outside bottom and inside bottom teeth. Begin brushing in section 1 (outside top teeth) and brush for 30 seconds before moving to section 2 (inside top teeth). Continue brushing for 30 seconds in each section progressing through all 4 sections until you've brushed for 2 minutes.
- 5** After the 2-minute brushing cycle is complete, additional time should be spent brushing the chewing surfaces of your teeth.

Press the power button to turn the brush on and off as needed.

To clean your mouth more completely, you may also brush your tongue, with the toothbrush turned on or off, as you prefer.

Tips for specific oral care needs

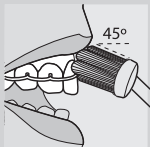

Stain removal

- ▶ In areas where excess staining occurs, spend extra brushing time to assist with stain removal.

Braces

- ▶ The brush should be placed at a 45-degree angle between your brackets and gumline. Using light pressure, gently move the bristles in a small circular motion so the longer bristles reach between your teeth for 2 seconds. Then gently turn (roll) the brush handle so the bristles clean the bracket and the rest of the tooth before you glide the bristles to the next tooth. Continue this until you have brushed all of your teeth. Please note that brush heads will wear out sooner when used on braces.

Dental restorations (dental work)

- ▶ Use Sonicare on dental restorations (such as implants, caps, crowns, bridges and fillings) as you would on your natural tooth surfaces to reduce plaque build-up and improve gum health. Work the bristles around all the areas of the restoration for thorough cleaning.

Periodontal pockets

- ▶ Your dental professional may have indicated that you have periodontal pockets, deep pockets where plaque bacteria collect. If this is the case, after brushing for a full 2 minutes, spend extra time gently brushing these areas to improve your gum health.

Features

Easy-start brushing power ramp-up

- ▶ All Sonicare models come with the Easy-start feature activated (on), which helps you get used to brushing with Sonicare.
- ▶ Brushing power will gently increase to full power over the first 12 brushings.
- ▶ The Easy-start feature is active if you hear 2 beeps immediately after turning on your Sonicare. Once you reach optimal brushing power (after the 12th brushing), you will no longer hear the double beep at the beginning of your brushing routine.

Note: Note: each of the first 12 brushings must be at least 1 minute in length to properly move through the Easy-start ramp-up cycle.

To deactivate or activate the Easy-start feature:

- 1** Attach your brush head to the handle.
- 2** Place the handle in a plugged-in charger base.
- 3** To deactivate the Easy-start feature, press and hold the power button for 5 seconds. You will hear 1 beep to indicate that the Easy-start feature has been deactivated.
- 4** To activate the Easy-start feature, press and hold the power button for 5 seconds. You will hear 2 beeps to indicate that the Easy-start feature has been activated.

Using the Easy-start feature beyond the initial ramp-up period is not recommended and reduces the effectiveness of your Sonicare toothbrush in removing plaque.

The Easy-start feature should be deactivated and the handle fully charged when Sonicare is used in clinical trials.

Smartimer 2-minute timer

- ▶ All Sonicare models come with the Smartimer feature, which automatically sets the brushing time to the 2 minutes recommended by dental professionals.
- ▶ After 2 minutes the Smartimer will automatically turn off the toothbrush.
- ▶ If you wish to pause or stop brushing during your 2-minute cycle, press the power button. Press the power button again and the Smartimer will pick up where you left off.
- ▶ The Smartimer will automatically reset to the beginning of a 2-minute cycle if:
 - brushing is paused for 30 seconds or longer;
 - the handle is returned to the charger base.

Quadpacer 30-second interval timer (available on select models).

- ▶ Quadpacer makes sure that you brush all sections of your mouth evenly and thoroughly. At 30, 60 and 90 seconds, you will hear a short beep and a pause in brushing action. This is your signal to move to the next section of your mouth.



Battery charge indicator (available on select models).

- ▶ If your Sonicare has a low charge, you will hear 5 beeps after you have brushed your teeth for 2 minutes and the charge indicator light will flash rapidly.

When you hear the low charge indication, you have 3 or fewer 2-minute brushings left.



- 1** Place the handle in the charger base (with the power button facing towards you) to begin the recharging process.
 - ▶ The charge indicator light flashes slowly when the handle is in the charger base to signal charging is in progress.
 - ▶ When the Sonicare is fully charged, the charge indicator light is constantly on (not flashing), signaling that your Sonicare is ready for use.
- When not in use, keep your Sonicare in the charger base to maintain a full battery charge.

Cleaning

By following these simple steps, you should get years of worry-free brushing:

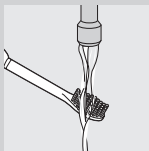

- 1** Rinse brush head and bristles after each use.

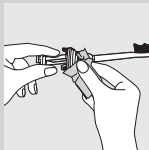

- 2** Clean the brush head at least once per week, including under the removable nut.
To remove the nut:

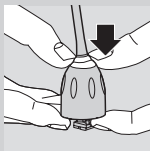

- ▶ Press down gently on the white area.

Avoid using sharp objects to push on the seal as this may cause damage.

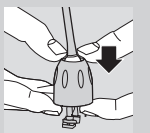

- ▶ Pull the nut up over the top of the brush head
To replace the nut, slip the nut over the brush head shaft and pull until it clicks back on.

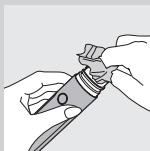

- 3** Clean and dry the handle periodically.

- 4** Clean the charger base periodically.

UNPLUG the charger before cleaning. After cleaning the charger base, completely dry the charger before plugging it into an electrical outlet.

Mild soap, water and a moist cloth are recommended for cleaning your Sonicare.

Additional Cleaning Tip:

- The Sonicare handle is dishwasher safe. Remove the brush head and charger before placing the handle only in the top rack of dishwasher.
- NOTE: Brush heads and charger base should never be placed in the dishwasher.

Storage

If the product is not to be used for an extended period of time it should be unplugged from the electrical outlet, cleaned, stored in a cool and dry area away from direct sunlight. The cord wrap can be used to store power cord in an organized manner.

Replacement

Brush head

Replace Sonicare brush heads every 3 months to achieve optimal results.

Environment

HANDLE CONTAINS NICKEL METAL HYDRIDE BATTERIES. BATTERIES MUST BE RECYCLED OR DISPOSED OF PROPERLY.



- The rechargeable battery inside your Sonicare cannot be replaced, but is easy to remove for recycling. At the end of product life and prior to disposal, please remove the rechargeable battery from the handle by following the instructions below.
- Do not throw away the appliance with the normal household waste at the end of its life, but hand it in at an official collection point for recycling. By doing this, you help to preserve the environment.
- If you have any recycling questions, contact your local waste management office.

Removing the batteries

Please note that this process is NOT reversible.

To remove the batteries yourself, you will need a flat-head (standard) screwdriver and a small towel. Basic safety precautions should be observed when following the procedure outlined below. Be sure to protect your eyes, hands, fingers and the surface on which you are working.

- 1** Deplete the battery of any charge by removing the handle from the charger, turning the Sonicare on and allowing it to run until it stops. Repeat this step until the Sonicare will no longer operate.

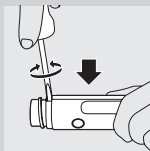

- 2** Insert a screwdriver into one of the slots located near the top portion of the handle, push the screwdriver blade into the handle as far as it will go, and twist the blade. The housing will begin to split.

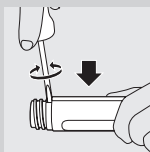

- 3** Remove the screwdriver and repeat the above instruction using the other slot located on the opposite side of the handle. Twist the blade and the housing will continue to split.

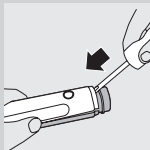

- 4** Now, insert the screwdriver into the middle slot located on the top front part of the handle as shown and push the blade in as far as it will go.

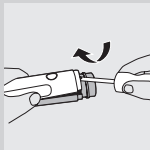

- 5** Now use the screwdriver as a lever to pry the 2 handle sections apart.

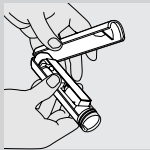

- 6** Pull the 2 handle sections completely apart.



- 7** Insert the screwdriver underneath the electronic circuit board in multiple places.

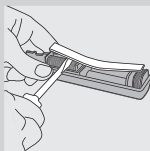

- 8** Twist and pry the electronic circuit board loose until it is completely separated from the handle.



- 9** Pry the 2 AA-sized cylindrical nickel metal-hydride batteries loose by inserting the screwdriver on the sides of the two batteries in the locations shown in the figure.

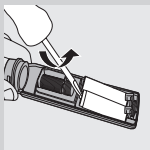

- 10** Use a twisting and prying motion to break the glue bond around the batteries. The 2 batteries are joined together with glue and will be lifted out together.

Guarantee and service

Philips guarantees its products for two years after the date of purchase. Defects due to faulty materials and workmanship will be repaired or replaced at Philips expense provided that convincing proof of purchase in the qualifying period is provided. Use of unauthorized replacement parts will void this warranty.

Contact our Customer Service Center at 1-800-682-7664 (North America), outside North America contact your local Philips Customer Care Center. Internet information: www.sonicare.com (North America) or www.philips.com (outside North America).

WARRANTY EXCLUSIONS

What is not covered under warranty:

- Brush heads
- Damage caused by use of unauthorized replacement parts.
- Damage caused by misuse, abuse, neglect, alterations or unauthorized repair.
- Normal wear and tear, including chips, scratches, abrasions, discoloration or fading.

IMPLIED WARRANTIES

ANY IMPLIED WARRANTIES, INCLUDING IMPLIED WARRANTIES OF MERCHANTABILITY AND FITNESS FOR A PARTICULAR PURPOSE, SHALL BE LIMITED TO THE DURATION OF THE EXPRESS WARRANTIES SET FORTH ABOVE. SOME STATES DO NOT ALLOW LIMITATION ON HOW LONG AN IMPLIED WARRANTY LASTS, SO THE ABOVE LIMITATION MAY NOT APPLY TO YOU.

LIMITATION OF REMEDIES

IN NO EVENT SHALL PHILIPS OR ANY OF ITS AFFILIATED OR SUBSIDIARY COMPANIES BE LIABLE FOR ANY SPECIAL, INCIDENTAL OR CONSEQUENTIAL DAMAGES BASED UPON BREACH OF WARRANTY, BREACH OF CONTRACT, NEGLIGENCE, TORT, OR ANY OTHER LEGAL THEORY. SUCH DAMAGES INCLUDE, WITHOUT LIMITATION, LOSS OF SAVINGS OR REVENUE; LOSS OF PROFIT; LOSS OF USE; THE CLAIMS OF THIRD PARTIES INCLUDING, WITHOUT LIMITATION, DENTISTS AND DENTAL HYGIENISTS; AND COST OF ANY SUBSTITUTE EQUIPMENT OR SERVICES. SOME STATES DO NOT ALLOW THE EXCLUSION OR LIMITATION OF INCIDENTAL OR CONSEQUENTIAL DAMAGES.

Troubleshooting

If you are unable to solve your problem by means of the troubleshooting guide below, please contact our Customer Service Center at 1-800-682-7664 (in North America), or the Philips Customer Care Center in your country.

Problem	Solution
The Sonicare toothbrush does not work	Recharge your Sonicare overnight, ensuring that it is not plugged into an electrical outlet controlled by a light switch. Make sure the brush head is attached correctly.
I feel a tickling sensation when I use Sonicare.	You may experience a slight tickling/tingling sensation when using Sonicare for the first time. As you become accustomed to brushing with Sonicare this sensitivity will diminish.
The brush head rattles when I use Sonicare	Sonicare should produce a gentle hum during operation. Tightening the brush head nut can eliminate excessive rattling. If rattling does not stop, you may need to replace the brush head. Make sure that the travel cap has been removed.
The brush head chatters against my teeth.	This can be avoided by keeping the brush head properly oriented, with the brush head placed on the gumline at an angle of 30 to 40 degrees.
Brushing seems less powerful.	The handle may need recharging. The Easy-start feature may be on and needs to be shut off (see chapter "Using the appliance") You may need to clean your brush head. You may need to replace your brush head.



www.philips.com/Sonicare

©2012 Koninklijke Philips Electronics NV (KPENV). All rights reserved.
PHILIPS and the Philips shield are registered trademarks of KPENV.
DiamondClean Easy-start, Quadpacer, Sonicare and the Sonicare logo
are trademarks of Philips Oral Healthcare, Inc. and/or KPENV.

Protected by U.S. and international patents. Other patents pending.
Reg. U.S. Pat. & Tm. Off.



100% recycled paper
100% papier recyclé

4235.020.5372.1