

# Always there to help you

Register your product and get support at  
[www.philips.com/support](http://www.philips.com/support)



M660

M665



## Extended user documentation

# PHILIPS



# Contents

<b>1</b>	<b>Important safety instructions</b>	<b>3</b>
<b>2</b>	<b>Your phone</b>	<b>4</b>
	What is in the box	4
	Overview of the phone	5
	Overview of the base station	6
<b>3</b>	<b>Get started</b>	<b>7</b>
	Connect the base station	7
	Install the handset	7
	Configure your phone (country dependent)	8
	Change the remote access PIN code (for M665)	9
	Charge the handset	9
	Check the battery level	9
	What is standby mode?	9
	Display icons	9
	Check the signal strength	10
	Switch the handset on or off	10
<b>4</b>	<b>Calls</b>	<b>11</b>
	Make a call	11
	Answer a call	11
	End a call	11
	Adjust the earpiece/speaker volume	12
	Mute the microphone	12
	Turn the speaker on or off	12
	Make a second call	12
	Answer a second call	12
	Switch between two calls	12
	Make a conference call with the external callers	13
<b>5</b>	<b>Intercom and conference calls</b>	<b>14</b>
	Make a call to another handset	14
	Make a conference call	14
<b>6</b>	<b>Text and numbers</b>	<b>16</b>
	Enter text and numbers	16
	Switch between uppercase and lowercase	16
<b>7</b>	<b>Phonebook</b>	<b>17</b>
	View the phonebook	17
	Search a record	17
	Call from the phonebook	17
	Access the phonebook during a call	17
	Add a record	18
	Edit a record	18
	Delete a record	18
	Delete all records	18
<b>8</b>	<b>Call log</b>	<b>19</b>
	Call list type	19
	View the call records	19
	Save a call record to the phonebook	19
	Return a call	20
	Delete a call record	20
	Delete all call records	20
<b>9</b>	<b>Redial list</b>	<b>21</b>
	View the redial records	21
	Redial a call	21
	Save a redial record to the phonebook	21
	Access the redial list during a call	21
	Delete a redial record	21
	Delete all redial records	21
<b>10</b>	<b>Phone settings</b>	<b>22</b>
	Sound settings	22
	Eco mode	23
	ECO+ mode	23
	Name the handset	24
	Set the date and time	24
	Set the display language	24
	Auto answer	24
	Activate/Deactivate auto hang up	24
	Base backlight	25
<b>11</b>	<b>Alarm clock</b>	<b>26</b>
	Set the alarm	26
	Turn off the alarm	26

---

<b>12 Telephone answering machine</b>	<b>27</b>
Turn the answering machine on or off	27
Family notes	27
Set the answering machine language	27
Announcements	27
Incoming messages	28
Set the ring delay	29
Remote access	29

---

<b>13 Services</b>	<b>31</b>
Call list type	31
Auto conference	31
Call barring	31
Blacklist	32
Network type	33
Auto prefix	33
Select the recall duration	33
Dial mode	33
Auto clock	34
Register additional handsets	34
Unregister the handsets	34
Restore default settings	35

---

<b>14 Technical data</b>	<b>36</b>
--------------------------	-----------

---

<b>15 Notice</b>	<b>37</b>
Declaration of conformity	37
Use GAP standard compliance	37
Compliance with EMF	37
Disposal of your old product and battery	37

---

<b>16 Frequently asked questions</b>	<b>39</b>
--------------------------------------	-----------

---

<b>17 Appendix</b>	<b>41</b>
Text and number input tables	41

---

<b>18 Index</b>	<b>43</b>
-----------------	-----------

# 1 Important safety instructions

## Power requirements

- This product requires an electrical supply of 100-240 volts AC. In case of power failure, the communication can be lost.
- The voltage on the network is classified as TNV-3 (Telecommunication Network Voltages), as defined in the standard EN 60950.



### Warning

- The Electrical network is classified as hazardous. The only way to power down the charger is to unplug the power supply from the electrical outlet. Ensure that the electrical outlet is always easily accessible.

## To avoid damage or malfunction



### Caution

- Use only the power supply listed in the user instructions.
- Use only the batteries listed in the user instructions.
- Risk of explosion if battery is replaced by an incorrect type.
- Dispose of used batteries according to the instructions.
- Do not dispose of batteries in fire.
- Always use the cables provided with the product.
- Do not allow the charging contacts or the battery to come into contact with metal objects.
- Do not let small metal objects come into contact with the product. This can deteriorate audio quality and damage the product.
- Metallic objects may be retained if placed near or on the handset receiver.
- Do not use the product in places where there are explosive hazards.
- Do not open the handset, base station or charger as you could be exposed to high voltages.
- For pluggable equipment, the socket-outlet shall be installed near the equipment and shall be easily accessible.

- Handsfree activation could suddenly increase the volume in the earpiece to a very high level: make sure the handset is not too close to your ear.
- This equipment is not designed to make emergency calls when the power fails. An alternative has to be made available to allow emergency calls.
- Do not allow the product to come into contact with liquids.
- Do not use any cleaning agents containing alcohol, ammonia, benzene, or abrasives as these may harm the set.
- Do not expose the phone to excessive heat caused by heating equipment or direct sunlight.
- Do not drop your phone or allow objects to fall on your phone.
- Active mobile phones in the vicinity may cause interference.

## About operating and storage temperatures

- Operate in a place where temperature is always between 0°C to +40°C (up to 90% relative humidity).
- Store in a place where temperature is always between -20°C and +45°C (up to 95% relative humidity).
- Battery life may be shorter in low temperature conditions.

## 2 Your phone

Congratulations on your purchase and welcome to Philips!

To fully benefit from the support that Philips offers, register your product at [www.philips.com/welcome](http://www.philips.com/welcome).

---

### What is in the box



Handset\*\*



Base station (with two connectors)



Charger\*\* (with one connector)

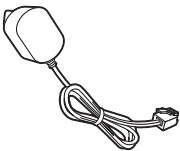

Power adapter (for base station)



Power adapter\*\* (for charger)

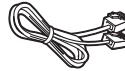

Line cord\*



Guarantee



Short user manual

#### Note

- \* In some countries, you have to connect the line adapter to the line cord, then plug the line cord to the telephone socket.

#### Tip

- \*\* In multi-handset packs, there are additional handsets and chargers and power adapters.

## Overview of the phone

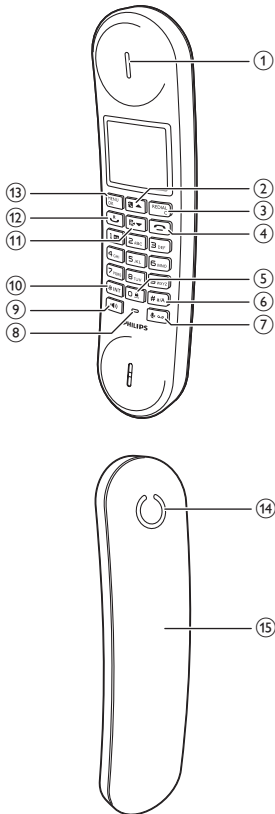

### ① Earpiece

### ②

- Scroll up on the menu.
- Increase the earpiece/speaker volume.
- Access the phonebook.

### ③ REDIAL/C

- Delete text or digits.
- Cancel operation.
- Access the redial list in standby mode.
- Change the sound profile during a call.

### ④

- End the call.
- Exit the menu/operation.
- Press and hold to switch the handset on or off.

### ⑤

- Press to enter a space during text editing.
- Press and hold to lock/unlock the keypad in standby mode.

### ⑥ # \*/A

- Press and hold to enter a pause when making a call.
- Switch to upper/lower case during editing.

### ⑦ (for M660) or / (for M665)

- Mute or unmute the microphone.
- Access to the answer machine menu in standby mode (for M665 only).
- Listen to new messages from the answering machine (for M665 only).

### ⑧ Microphone

### ⑨

- Turn the speaker phone on/off.
- Make and receive calls through the speaker.

### ⑩ \*INT

- Press and hold to make an intercom call (for multi-handset version only).
- Set the dial mode (pulse mode or temporary tone mode).

### ⑪

- Scroll down on the menu.
- Decrease the earpiece/speaker volume.
- Access the call log in standby mode.

### ⑫

- Make and receive calls.
- Recall key (This function is network dependent.)

⑬ MENU/OK

- Access the main menu in standby mode.
- Confirm selection.
- Enter the options menu.
- Select the function displayed on the handset screen directly above the key.

⑭ Loudspeaker

⑮ Handset back cover

---

## Overview of the base station

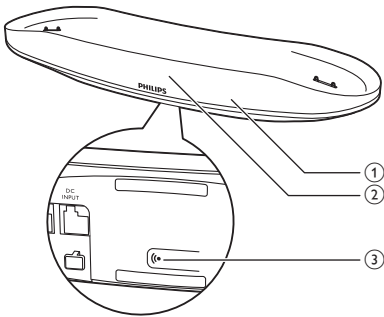

① LED indicator

- Off: no new event.
- On: in a call.
- Flashing: new missed calls/new messages on answering machine/new voice mails/registration mode.

② LCD display

- The caller's name and number are displayed alternately when there is an incoming call.
- The time is displayed in standby mode.

③ •))

- Press to find handsets.
- Press and hold to enter the registration mode.



# 3 Get started

## ! Caution

- Make sure that you have read the safety instructions in the 'Important safety instructions' section before you connect and install your handset.

## Connect the base station

## ! Warning

- Risk of product damage! Ensure that the power supply voltage corresponds to the voltage printed on the back or the underside of the phone.
- Use only the supplied power adapter to charge the batteries.

## ☰ Note

- If you subscribe to the digital subscriber line (DSL) high speed internet service through your telephone line, ensure you install a DSL filter between the telephone line cord and the power socket. The filter prevents noise and caller ID problems caused by the DSL interference. For more information on the DSL filters, contact your DSL service provider.
- The type plate is located on the bottom of the base station.

- 1 Connect each end of the power adapter to:
  - the DC input jack at the bottom of the base station;
  - the power socket on the wall.
- 2 Connect each end of the line cord to:
  - the telephone socket at the bottom of the base station;
  - the telephone socket on the wall.

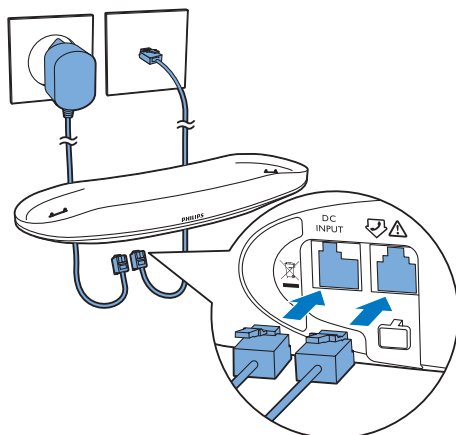

- 3 Connect each end of the power adapter to (for multi handset version only):
  - the DC input jack at the bottom of the extra handset charger;
  - the power socket on the wall.

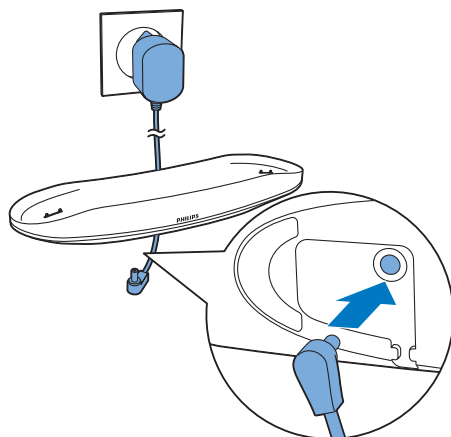

## Install the handset

The batteries are pre-installed in the handset. Pull the battery tape off from the battery door before charging.

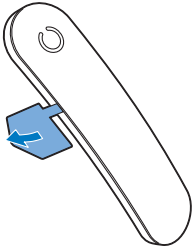

### ! Caution

- Risk of explosion! Keep batteries away from heat, sunshine or fire. Never discard batteries in fire.
- Use only the supplied batteries.
- Risk of decreased battery life! Never mix different brands or types of batteries.

### ☰ Note

- Charge the batteries for 8 hours before first use.
- If the handset becomes warm when the batteries are being charged, it is normal.

### ! Warning

- Check the battery polarity when inserting in the battery compartment. Incorrect polarity may damage the product.

## Configure your phone (country dependent)

- 1 When using your phone for the first time, you see a welcome message.
- 2 Press **MENU/OK**.

### Set the country/language

Select your country/language, then press **MENU/OK** to confirm.

↳ The country/language setting is saved.

### ☰ Note

- The country/language setting option is country dependent. If no welcome message is displayed, it means the country/language setting is preset for your country. Then you can set the date and time.

To reset the language, see the following steps.

- 1 Select **MENU/OK** > **[Phone setup]** > **[Language]**, then press **MENU/OK** to confirm.
- 2 Select a language, then press **MENU/OK** to confirm.  
↳ The setting is saved.

### Set the date and time

- 1 Press **MENU/OK**.
- 2 Select **[Phone setup]** > **[Date & time]**, then press **MENU/OK** to confirm.
- 3 Press the numeric buttons to enter the date, then press **MENU/OK** to confirm.  
↳ The time setting menu is displayed on the handset.
- 4 Press the numeric buttons to enter the time.
  - If the time is in 12-hour format, press **🕒 ▲ / 🕒 ▼** to select **[am]** or **[pm]** (Country dependent).
- 5 Press **MENU/OK** to confirm.

### ☰ Note

- The base clock is automatically synchronized with the handset clock.

## Change the remote access PIN code (for M665)

### Note

- This feature is available only for models with answering machine.
- The default answering machine remote access PIN code is 0000 and it is important to change it to ensure the security.

- 1 Press **OK** / **☰** or **MENU/OK** > [**Answ. Machine**] > **MENU/OK**.
- 2 Select [**Remote access**] > [**Change PIN**], then press **MENU/OK** to confirm.
- 3 Enter the old PIN/passcode, then press **MENU/OK** to confirm.
- 4 Enter the new PIN/passcode, then press **MENU/OK** to confirm.
- 5 Enter the new PIN/passcode again, then press **MENU/OK** to confirm.  
↳ The setting is saved.

## Charge the handset

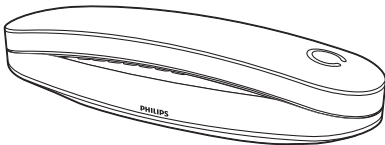

Charge your handset by docking it in either direction. When the handset is placed correctly on the base station, you hear a docking tone (see 'Set the docking tone' on page 21).

↳ The handset starts charging.

### Note

- Charge the batteries for 8 hours before first use.
- If the handset becomes warm when the batteries are being charged, it is normal.
- Over time, capacity of batteries decreases. This is a normal battery behavior.

Your phone is now ready to use.

## Check the battery level

The battery icon displays the current battery level.

	When the handset is off the base station, the bars indicate the battery level (full, medium and low).
	When the handset is on the base station/charger, the bars flash until charging is complete.
	The empty battery icon flashes. The battery is low and needs recharging.

The handset LCD backlight turns off if the battery level is low. The handset turns off if the batteries are empty. If you are on the phone, you hear warning tones when the batteries are almost empty. The call gets disconnected after the warning.













## What is standby mode?



Your phone is in standby mode when it is idle. The handset name, date and time, and handset number are displayed on the handset screen.

## Display icons

In standby mode, the icons shown on the main screen tell you what features are available on your handset.

Icon	Descriptions
------	--------------

	When the handset is off the base station/charger, the bars indicate the battery level (from full to low). When the handset is on the base station/charger, the bars keep scrolling until charging is complete.
	
	The empty battery icon flashes and you hear an alert tone. The battery is low and needs recharging.
	It shows the connection status between the handset and base station. The more bars are shown, the better the signal strength is.
	It remains steadily on when browsing incoming calls in the call log.
	It remains steadily on when browsing outgoing calls in the redial list.
	It flashes when there is a new missed call or when browsing unread missed calls in call log. It remains steady on when browsing the read missed calls in call log.
	It remains steadily on when browsing blocked calls in call log.
	It flashes when receiving incoming call. It remains steadily on when you are in a call.
	The speaker is on.
	The ringer is off. The silent mode is set and within active period (the phone does not ring).
	Answering machine (M665 only): it flashes when there is a new message or when the memory is full. It is displayed when the telephone answering machine is turned on.
	It flashes when there is a new voice message. It remains steadily on when the voice messages are already viewed in the call log. The icon is not shown when there is no voice message.

	The silent mode is set, but is outside of active period.
	The alarm is activated.
	It is displayed when you adjust the volume.
<b>ECO</b>	The <b>Eco</b> mode is activated.
<b>ECO+</b>	The <b>ECO+</b> mode is activated.

## Check the signal strength

	The number of bars indicates the connection status between the handset and base station. The more bars are shown, the better the connection is.
---	---

- Make sure the handset is connected to the base station before you make or receive calls and carry out the phone functions and features.
- If you hear warning tones when you are on the phone, the handset is almost out of battery or the handset is out of range. Charge the battery or move the handset nearer to the base station.

### Note

- When **ECO+** is on, the signal strength is not displayed.

## Switch the handset on or off

Press and hold  to switch the handset on or off.

# 4 Calls

## Note

- When the power fails, the phone cannot access emergency services.

## Tip

- Check the signal strength before you make a call or when you are in a call (see 'Check the signal strength' on page 10).



## Make a call

You can make a call in these ways:



- Normal call.
- Redial call.

You can also make a call from the redial list (see 'Redial a call' on page 20), phonebook list (see 'Call from the phonebook' on page 16) and call log (see 'Return a call' on page 18).

### Normal call

- 1 Press  or .
- 2 Dial the phone number.
  - ↳ The number is dialed out.
  - ↳ The duration of your current call is displayed.

### Redial call



- 1 Dial the phone number
  - To erase a digit, press **[Clear]**.
  - To enter a pause, press and hold #00.
- 2 Press  or  to dial out the call.

## Note

- The talk time of your current call is displayed on the call timer.
- If you hear warning tones, the phone is almost out of battery or out of range. Charge the battery or move the phone close to the base station.

## Answer a call

When there is an incoming call, the caller's name and number are displayed on the base LCD screen alternately. You can select from the following options:

- press  or  to answer the call.
- pick up the phone to answer the call when you activate the auto answer feature (see 'Auto answer' on page 23).
- select **[Silent]** to turn off the ringer of the current incoming call.

## Warning

- When the handset rings or when the handsfree is activated, keep the handset away from your ear to avoid ear damage.

## Note

- The caller ID service is available if you have registered to the caller ID service with your service provider.

## Tip

- When there is a missed call, a notification message is displayed.

## End a call

You can end a call in these ways:

- Press .
- Place the handset to the base station or charging cradle.

## Note

- Placing the handset to the base station or charging cradle does not end the call when the auto hangup feature is turned off (see 'Activate/Deactivate auto hang up' on page 23).

## Adjust the earpiece/speaker volume

Press ▲ / ▼ to adjust the volume during a call.

- ↳ The earpiece/speaker volume is adjusted and the phone is back to the call screen.

## Mute the microphone

- 1 Press during a call.
  - ↳ **[Mute on]** is displayed on the handset.
  - ↳ The caller cannot hear you, but you can still hear his voice.
- 2 Press again to unmute the microphone.
  - ↳ You can now communicate with the caller.

## Turn the speaker on or off

Press .

## Make a second call

### Note

- This service is network dependent.

- 1 Press during a call.
  - ↳ The first call is put on hold.
- 2 Dial the second number:
  - ↳ The number displayed on the screen is dialed out.

## Answer a second call

### Note

- This service is network dependent.

When there is a periodical beep to notify you of an incoming call, you can answer the call in these ways:

- 1 Press and **2<sub>ABC</sub>** to answer the call.
  - ↳ The first call is put on hold, and you are now connected to the second call.
- 2 Press and **1<sub>ABC</sub>** to end the current call and answer the first call.

## Switch between two calls

### Note

- This service is network dependent.

You can switch your calls in these ways:

- Press and **2<sub>ABC</sub>**; or
- Press **[Option]** and select **[Switch calls]**, then press **[OK]** again to confirm.
  - ↳ The current call is put on hold, and you are now connected to the other call.

---

## Make a conference call with the external callers

### Note

- This service is network dependent. Check with the service provider for additional charges.

When you are connected to two calls, you can make a conference call in these ways:

- Press **☺<sup>R</sup>**, then **☹<sub>DEF</sub>**; or
- Press **[Option]**, select **[Conference]** and then press **[OK]** again to confirm.
  - ↳ The two calls are combined and a conference call is established.

# 5 Intercom and conference calls

## Note

- This feature is available for multi- handset versions only.

An intercom call is a call to another handset that shares the same base station. A conference call involves a conversation between you, another handset user and the outside callers.

## Make a call to another handset

## Note

- If the base station only has 2 registered handsets, press and hold \*INT to make a call to another handset.

- 1 Press and hold \*INT.
  - ↳ For multi-handset versions, the handsets available for intercom are displayed, then go to step 2.
  - ↳ For two-handset versions, the other handset rings, then go to step 3.
- 2 Select a handset number; then press **MENU/OK** to confirm.
  - ↳ The selected handset rings.
- 3 Press **↩** on the selected handset.
  - ↳ The intercom is established.
- 4 Press **⏏** to end the intercom call.

## While you are on the phone

You can go from one handset to another during a call:

- 1 Press and hold \*INT.
  - ↳ The current caller is put on hold.
  - ↳ For multi-handset versions, the handsets available for intercom are displayed, then go to step 2.
- 2 Select a handset number; then press **MENU/OK** to confirm.
  - ↳ Wait for the other side to answer your call.

## Switch between calls

Press and hold \*INT to switch between the outside call and the intercom call.

## Make a conference call

A 3-way conference call is between you, another handset user and the outside callers. It requires two handsets to share the same base station.



---

## During an external call

- 1 Press and hold **\*INT** to initiate an internal call.
  - ↳ The external caller is put on hold.
  - ↳ For multi-handset versions, the handsets available for intercom are displayed, then go to step 2.
  - ↳ For two-handset versions, the other handset rings, then go to step 3.
- 2 Select or enter a handset number, then press **MENU/OK** to confirm.
  - ↳ The selected handset rings.
- 3 Press **⌂** on the selected handset.
  - ↳ The intercom is established.
- 4 Press **MENU/OK**.
  - ↳ You are now in a 3-way conference call with an external call and a selected handset.
- 5 Press **⏏** to end the conference call.

### Note

- Press **⌂** to join an ongoing conference with another handset if **[Services] > [Conference]** is set to **[Auto]**.

---

## During the conference call

- 1 Press and hold **\*INT** to put the external call on hold and go back to the internal call.
  - ↳ The external call is put on hold.
- 2 Press and hold **MENU/OK** to establish the conference call again.

### Note



- If a handset hangs up during the conference call, the other handset remains connected to the external call.

# 6 Text and numbers

You can enter text and numbers for handset name, phonebook records, and other menu items.

---

## Enter text and numbers

- 1 Press once or several times on the alphanumeric key to enter the selected character.
- 2 Press **REDIAL/C** to delete a character. Press and hold **REDIAL/C** to delete all characters. Press  **▲** and  **▼** to move the cursor left and right.
- 3 Press **o a** to add a space.



### Note

- For information on key mapping of characters and numbers, see the chapter 'Appendix'.

---

## Switch between uppercase and lowercase

By default, the first letter of each word in a sentence is uppercase and the rest is lowercase. Press and hold **#\*A** to switch between the uppercase and lowercase letters.

# 7 Phonebook

This phone has a phonebook that stores up to 100 records. You can access the phonebook from the base station. Each record can have a name up to 16 characters long. It can store up to 3 numbers, with each number up to 24 digits long.

You have up to 2 direct access memories (Keys 1 and 2). Depending on your country, keys 1 and 2 are preset to the voice mail number and information service number of your service provider respectively. When you press and hold on the key in standby mode, the saved phone number is dialed automatically.

## Note

- The availability of direct access memory is country dependent.

## View the phonebook

### Note

- You can view the phonebook on one handset only each time.



- 1 Press  ▲ or press MENU/OK > [Phonebook] > [View] > MENU/OK to access the phonebook list.
- 2 Select a contact and view the available information.

## Search a record

You can search the phonebook records in these ways:

- Scroll the contacts list.
- Enter the first character of the contact.



## Scroll the contact list

- 1 Press  ▲ or press MENU/OK > [Phonebook] > [View] > MENU/OK to access the phonebook list.
- 2 Press  ▲ and  ▼ to scroll through the phonebook list.

## Enter the first character of a contact

- 1 Press  ▲ or press MENU/OK > [Phonebook] > [View] > MENU/OK to access the phonebook list.
- 2 Press the alphanumerical key that matches the character.
  - ↳ The first record that starts with this character is displayed.

## Call from the phonebook

- 1 Press  ▲ or press MENU/OK > [Phonebook] > [View] > MENU/OK to access the phonebook list.
- 2 Select a contact in the phonebook list.
- 3 Press MENU/OK.
- 4 Select a type of number (mobile/home/office), then press  to make the call.

## Access the phonebook during a call

- 1 Press MENU/OK and select [Phonebook], then press MENU/OK to confirm.
- 2 Select a contact, then press MENU/OK to view the number.

---

## Add a record

### Note

- If your phonebook memory is full, a notification message is displayed on the handset. Delete some records to add new ones.
- When you change the number of a record, the new number will overwrite the old number.

- 1 Press **MENU/OK**.
- 2 Select **[Phonebook]** > **[Add new]**, then press **MENU/OK** to confirm.
- 3 Enter the name, then press **MENU/OK** to confirm.
- 4 Enter the mobile number, home number and office number, then press **MENU/OK** to confirm.  
↳ Your new record is saved.

### Tip

- Press and hold **#\*\*A** to insert a pause.
- Press once or several times on the alphanumeric key to enter the selected character.
- Press **REDIAL/C** to delete the character: Press **⏪ ▲ / ⏩ ▼** to move the cursor left and right.

### Note

- You can save 3 numbers at maximum per each phonebook entry.

---

## Edit a record

- 1 Press **MENU/OK**.
- 2 Select **[Phonebook]** > **[Edit]**, then press **MENU/OK** to confirm.
- 3 Select a contact, then press **MENU/OK** to confirm.
- 4 Edit the name, then press **MENU/OK** to confirm.
- 5 Edit the mobile/home/office number, then press **MENU/OK** to confirm.  
↳ The record is saved.

---

## Delete a record

- 1 Press **MENU/OK**.
- 2 Select **[Phonebook]** > **[Delete]**, then press **MENU/OK** to confirm.
- 3 Select a contact, then press **MENU/OK** to confirm.  
↳ A confirmation request is displayed on the handset.
- 4 Press **MENU/OK** to confirm.  
↳ The record is deleted.

---

## Delete all records

- 1 Press **MENU/OK**.
- 2 Select **[Phonebook]** > **[Delete all]**, press **MENU/OK** to confirm.  
↳ A confirmation request is displayed on the handset.
- 3 Press **MENU/OK** to confirm.  
↳ All records (except the 2 direct access memory records) are deleted.



# 8 Call log

The call log stores the incoming call history of all missed, received or blocked calls. The incoming call history includes the name and number of the caller; call time and date. This feature is available if you have registered to the caller ID service with your service provider. Your phone can store up to 50 incoming call records. The call log icon on the handset flashes to remind you of any unanswered calls. If the caller allows the display of his identity, you can view his name or number. The call records are displayed in chronological order with the most recent received call at the top of the list.

## Note

- Make sure that the number in the call list is valid before you can call back directly from the call list.

The icons shown on the screen tell you whether they are missed/received/blocked calls.

Icons	Description
	It remains steadily on when browsing answered incoming calls in the call log.
	It flashes when there is a new missed call or when browsing unread missed calls in call log. It remains steady on when browsing the read missed calls in call log.
	It remains steadily on when browsing blocked calls in call log.

## Call list type

You can set if you can see all incoming calls or only missed calls from the call log.

## Note

- This is a country dependent feature.

## Select the call list type

- 1 Press **MENU/OK**.
- 2 Select **[Services] > [Call list type]**, then press **MENU/OK** to confirm.
- 3 Select an option, then press **MENU/OK** to confirm.

## View the call records



- 1 Press .  
↳ The incoming call log is displayed.
- 2 Select a record, then press **MENU/OK** and select **[View] > MENU/OK** for more available information.

## Save a call record to the phonebook

- 1 Press .  
↳ The incoming call log is displayed.
- 2 Select a record, then press **MENU/OK** to confirm.
- 3 Select **[Save number]**, then press **MENU/OK** to confirm.
- 4 Enter and edit the name, then press **MENU/OK** to confirm.
- 5 Select a type of number (mobile/home/office), then press **MENU/OK** to confirm.
- 6 Edit the number; then press **MENU/OK** to confirm.  
↳ The record is saved.

---

## Return a call

- 1 Press  ▼.
- 2 Select a record on the list.
- 3 Press  to make the call.

---

## Delete a call record

- 1 Press  ▼.  
↳ The incoming call log is displayed.
- 2 Select a record, then press **MENU/OK** to confirm.
- 3 Select [**Delete**], then press **MENU/OK** to confirm.  
↳ A confirmation request is displayed on the handset.
- 4 Press **MENU/OK** to confirm.  
↳ The record is deleted.

---

## Delete all call records

- 1 Press  ▼.  
↳ The incoming call log is displayed.
- 2 Press **MENU/OK** to enter the options menu.
- 3 Select [**Delete all**], then press **MENU/OK** to confirm.  
↳ A confirmation request is displayed on the handset.
- 4 Press **MENU/OK** to confirm.  
↳ All records are deleted.

## 9 Redial list

The redial list stores the call history of dialed calls. It includes the names and/or numbers you have called. This phone can store up to 20 redial records.

---

### View the redial records

Press **REDIAL/C**.

---

### Redial a call

- 1 Press **REDIAL/C**.
- 2 Select a record, then press .  
↳ The number is dialed out.

---

### Save a redial record to the phonebook

- 1 Press **REDIAL/C** to enter the list of dialed calls.
- 2 Select a record, then press **MENU/OK** to confirm.
- 3 Press **MENU/OK**, select [**Save number**], then press **MENU/OK** to confirm.
- 4 Enter and edit the name, then press **MENU/OK** to confirm.
- 5 Select a type of number (mobile/home/office), then press **MENU/OK** to confirm.
- 6 Edit the number, then press **MENU/OK** to confirm.  
↳ The record is saved.

---

### Access the redial list during a call

- 1 Press **MENU/OK** and select [**Redial**].
- 2 Press **MENU/OK** to confirm.

---

### Delete a redial record

- 1 Press **REDIAL/C** to enter the list of dialed calls.
- 2 Select a record, then press **MENU/OK** to confirm.
- 3 Press **MENU/OK**, select [**Delete**], then press **MENU/OK** to confirm.  
↳ A confirmation request is displayed on the handset.
- 4 Press **MENU/OK** to confirm.  
↳ The record is deleted.

---

### Delete all redial records

- 1 Press **REDIAL/C** to enter the list of dialed calls.
- 2 Press **MENU/OK**, select [**Delete all**], then press **MENU/OK** to confirm.  
↳ A confirmation request is displayed on the handset.
- 3 Press **MENU/OK** to confirm.  
↳ All records are deleted.

# 10 Phone settings

You can customize the settings to make it your own phone.

---

## Sound settings

---

### Set the handset's ringtone volume

You can select among 5 ringtone volume levels or [Off].

- 1 Press **MENU/OK**.
- 2 Select [**Phone setup**] > [**Sounds**] > [**Ring volume**], then press **MENU/OK** to confirm.
- 3 Select a volume level, then press **MENU/OK** to confirm.  
↳ The setting is saved.

---

### Set the handset's ringtone

You can select from 10 ringtones.

- 1 Press **MENU/OK**.
- 2 Select [**Phone setup**] > [**Sounds**] > [**Ring tones**], then press **MENU/OK** to confirm.
- 3 Select a ringtone, then press **MENU/OK** to confirm.  
↳ The setting is saved.

---

### Silent mode

You can set your phone to silent mode and enable the silent mode for a specified duration. When the silent mode is turned on, your phone does not ring or send any alerts or sound.

### Note

- When you press **••**) to find your handset, or when you activate the alarm, your phone still sends alert even when the silent mode is activated.

- 1 Press **MENU/OK**.
- 2 Select [**Phone setup**] > [**Sounds**] > [**Silent mode**], then press **MENU/OK** to confirm.
- 3 Select [**On/off**] > [**On**]/[**Off**], then press **MENU/OK** to confirm.  
↳ The setting is saved.
- 4 Select [**Start & end**], then press **MENU/OK** to confirm.
- 5 Set the time, then press **MENU/OK** to confirm.  
↳ The setting is saved.  
↳ **••** is displayed.

---

### Set the key tone

Key tone is the sound made when you press a key on the handset.

- 1 Press **MENU/OK**.
- 2 Select [**Phone setup**] > [**Sounds**] > [**Key tone**], then press **MENU/OK** to confirm.
- 3 Select [**On**]/[**Off**], then press **MENU/OK** to confirm.  
↳ The setting is saved.

---

### Set the docking tone

Docking tone is the sound made when you place the handset on the base station or charger.

- 1 Press **MENU/OK**.
- 2 Select [**Phone setup**] > [**Sounds**] > [**Docking tone**], then press **MENU/OK** to confirm.
- 3 Select [**On**]/[**Off**], then press **MENU/OK** to confirm.  
↳ The setting is saved.



---

## Set the battery tone

Battery tone is the sound made when the battery is low and needs recharging.

- 1 Press **MENU/OK**.
- 2 Select **[Phone setup] > [Sounds] > [Battery tone]**, then press **MENU/OK** to confirm.
- 3 Select **[On]/[Off]**, then press **MENU/OK** to confirm.  
↳ The setting is saved.

---

## Set the sound profile

You can set the sound in the earpiece among 3 different profiles.

- 1 Press **MENU/OK**.
- 2 Select **[Phone setup] > [Sounds] > [MySound]**, then press **MENU/OK** to confirm.
- 3 Select a profile, then press **MENU/OK** to confirm.  
↳ The setting is saved.

### Access the sound profile during a call

Press **REDIAL/C** for once or several times to change the sound profile during a call.

---

## Eco mode

The **ECO** mode reduces the transmission power of the handset and base station when you are on a call or when the phone is in standby mode.

- 1 Press **MENU/OK**.
- 2 Select **[Phone setup] > [Eco mode]**, then press **MENU/OK** to confirm.
- 3 Select **[On]/[Off]**, and press **MENU/OK** to confirm.  
↳ The setting is saved.  
↳ **ECO** is displayed in standby mode.

---

### Note

- When **ECO** mode is set to **[On]**, the connection range between the handset and the base station can be reduced.

---

## ECO+ mode

When the **ECO+** mode is activated, it eliminates the radiation of the handset and base station in standby mode.

- 1 Press **MENU/OK**.
- 2 Select **[Phone setup] > [ECO+ mode]**, then press **MENU/OK** to confirm.
- 3 Select **[On]/[Off]**, and press **MENU/OK** to confirm.  
↳ The setting is saved.  
↳ **ECO+** is displayed in standby mode after a while.

---

### Note

- Make sure that all the handsets registered to the base station are M660/M665 in order to have the **ECO+** feature functioning properly.
- When **ECO+** is activated, the standby time is reduced. This is because in **ECO+** mode the base station is not transmitting any signal in standby mode; therefore the handset needs to "listen" more frequently for signals from the base station to detect incoming calls or other requests from the base station. The time it takes for the handset to access features like call setup, call log, paging, and phonebook browsing is also delayed. The handset will not alert you to link loss in case of power loss or moving out of range.

The following table shows you the current status of the handset screen with different **ECO** mode and **ECO+** mode settings.

---

<b>ECO</b> mode	<b>ECO+</b> mode	Handset icon display
<b>[Off]</b>	<b>[Off]</b>	<b>eco</b> and <b>ECO+</b> are off.

---

[Off]	[On]	<b>ECO+</b> is displayed only after the <b>ECO+</b> mode is activated during standby mode .
[On]	[Off]	<b>eco</b> is displayed.
[On]	[On]	<b>eco</b> is displayed and changed to <b>ECO+</b> when the <b>ECO+</b> mode is activated in standby mode.

## Name the handset

The name of the handset can be up to 14 characters. It is displayed on the handset screen in standby mode.

- 1 Press **MENU/OK**.
- 2 Select **[Phone setup] > [Phone name]**, then press **MENU/OK** to confirm.
- 3 Enter or edit the name. To erase a character, press **REDIAL/C**.
- 4 Press **MENU/OK** to confirm.  
↳ The setting is saved.

## Set the date and time

For information, see 'Set the date and time' in the 'Get started' section.

## Set the display language

### Note

- This feature only applies to models with multiple-language support.
- Languages available vary from country to country.

- 1 Press **MENU/OK**.
- 2 Select **[Phone setup] > [Language]**, then press **MENU/OK** to confirm.
- 3 Select a language, then press **MENU/OK** to confirm.  
↳ The setting is saved.

## Auto answer

When you activate the auto answer feature, you can connect to the incoming call automatically once you pick up the handset. When you deactivate this feature, you have to press **END** or **CALL** to answer the incoming call.

- 1 Press **MENU/OK**.
- 2 Select **[Phone setup] > [Auto answer]**, then press **MENU/OK** to confirm.
- 3 Select **[On]/[Off]**, then press **MENU/OK** to confirm.  
↳ The setting is saved.

## Activate/Deactivate auto hang up

You can activate the auto hang up function so that you can end a call by simply placing the handset on the base station or charge cradle.

- 1 Press **MENU/OK**.
- 2 Select **[Phone setup] > [Auto hang-up]**, then press **MENU/OK** to confirm.
- 3 Select **[On]/[Off]**, then press **MENU/OK** to confirm.  
↳ The setting is saved.

## Note

- When auto hang up is deactivated, you can put the handset to the base station or charging cradle and continue with your call through the speaker.

---

## Base backlight

You can activate the base backlight within a certain time period when the phone is in standby mode.

---

### Activate/Deactivate the base backlight

- 1 Press **MENU/OK**.
- 2 Select **[Phone setup] > [Base backlight]**, then press **MENU/OK** to confirm.
- 3 Select **[On/off] > [On]/[Off]**, then press **MENU/OK** to confirm.  
↳ The setting is saved.

---

### Set the base backlight duration

- 1 Press **MENU/OK**.
- 2 Select **[Phone setup] > [Base backlight]**, then press **MENU/OK** to confirm.
- 3 Select **[Start & end]**, then press **MENU/OK** to confirm.
- 4 Follow the screen instruction to set the time duration, then press **MENU/OK** to confirm.  
↳ The setting is saved.

# 11 Alarm clock

Your phone has a built-in alarm clock. Check the information below to set your alarm clock.



---

## Set the alarm

- 1 Press **MENU/OK**.
- 2 Select **[Alarm]**, then press **MENU/OK** to confirm.
- 3 Select **[On once]** or **[On daily]**, then press **MENU/OK** to confirm.
- 4 Enter an alarm time, then press **MENU/OK** to confirm.
  - ↳ The alarm is set and  is displayed on the screen.



### Tip

- Press  /  to switch between **[am]**/**[pm]** (Country dependent).

---

## Turn off the alarm

---

### When the alarm rings

Press any key to turn off the alarm.

---

### Before the alarm rings

- 1 Press **MENU/OK**.
- 2 Select **[Alarm]** > **[Off]**, then press **MENU/OK** to confirm.
  - ↳ The setting is saved.

# 12 Telephone answering machine

## Note

- Available only for M665.

Your phone includes a telephone answering machine that records unanswered calls when it is on. By default, the answering machine is set to the **[Record also]** mode. You can access the answering machine remotely and change the settings through the answering machine menu on the handset.

## Turn the answering machine on or off

- 1 Press **☰** / **☰** or **MENU/OK** > **[Answ. Machine]** > **MENU/OK**.
- 2 Select **[Voice answer]**, then press **MENU/OK** to confirm.
- 3 Select **[Answer only]/[Record also]/[Off]**, then press **MENU/OK** to confirm.  
↳ The setting is saved.

## Note

- **[Answer only]** means the answering machine is on. Calls are only answered, messages are not recorded.
- **[Record also]** means the answering machine is on. Calls are answered and messages are recorded.
- **[Off]** means the answering machine is off.

## Family notes

You can leave your family an audio note in the answering machine.

- 1 Press **☰** / **☰** or **MENU/OK** > **[Answ. Machine]** > **[Family note]**, then press **MENU/OK** to confirm.
- 2 Start recording close to the microphone after the beep.
- 3 Press **MENU/OK** to stop recording or the recording stops after 3 minutes.
- 4 Press **MENU/OK** to listen to the audio note.
- 5 Press **MENU/OK** to save the family note or **REDIAL/C** to remove it.

## Set the answering machine language

### Note

- This feature only applies to models with multiple-language support.

The answering machine language is the language for the announcements.

- 1 Press **☰** / **☰** or **MENU/OK** > **[Answ. Machine]** > **MENU/OK**.
- 2 Select **[Voice language]**, then press **MENU/OK** to confirm.
- 3 Select a language, then press **MENU/OK** to confirm.  
↳ The setting is saved.



## Announcements

The announcement is the message your caller hears when the answering machine picks up the call. The answering machine has 2 pre-recorded announcements: **[Record also]** and **[Answer only]**.

---

## Record an announcement

The maximum length of the announcement you can record is 3 minutes. The newly recorded announcement automatically replaces the old one.



- 1 Press  /  or MENU/OK > [Answ. Machine] > MENU/OK.
- 2 Select [Announcement], then press MENU/OK to confirm.
- 3 Select [Answer only] or [Record also], then press MENU/OK to confirm.
- 4 Select [Record], then press MENU/OK to confirm.
- 5 Start recording close to the microphone after the beep.
- 6 Press MENU/OK to stop recording or the recording stops after 3 minutes.  
↳ You can listen to the newly recorded announcement on the handset.

### Note

- Make sure that you speak close to the microphone when you record an announcement.

---

## Listen to the announcement



- 1 Press  /  or MENU/OK > [Answ. Machine] > MENU/OK.
- 2 Select [Announcement], then press MENU/OK to confirm.
- 3 Select [Answer only] or [Record also], then press MENU/OK to confirm.
- 4 Select [Play], then press MENU/OK to confirm.  
↳ You can listen to the current announcement.

### Note

- You can no longer listen to the announcement when you pick up an incoming call.

---

## Restore the default announcement

- 1 Press  /  or MENU/OK.
- 2 Select [Answ. Machine] > [Announcement], then press MENU/OK to confirm.
- 3 Select [Record also] or [Answer only], then press MENU/OK to confirm.
- 4 Select [Use default], then press MENU/OK to confirm.  
↳ The default announcement is restored

---

## Incoming messages

Each message can be up to 3 minutes long. When you receive new messages, the LED indicator on the base station flashes.





### Note

- If you pick up the phone when the caller leaves a message, the recording stops and you can talk to the caller directly.
- If the memory is full, the answering machine switches to [Answer only] automatically. Delete old messages to receive new ones.

---

## Listen to the incoming message

You can listen to the incoming messages in the sequence they are recorded.



- If there are new messages, press  /  to listen. If there is no new message, press  / , then MENU/OK to listen to old messages.
- Press MENU/OK > [Answ. Machine] > [Play], then press MENU/OK to confirm.  
↳ New messages start playing. Old messages start playing if there is no new message.
- Press REDIAL/C to stop listening.
- Press MENU/OK to enter the options menu.

- Press   to increase/decrease the volume.

## Delete an incoming message

- 1 When you listen to the message, press **MENU/OK** to enter the options menu.
- 2 Select **[Delete]**, then press **MENU/OK** to confirm.
  - ↳ The current message is deleted.

## Delete all old incoming messages



- 1 Press  /  or **MENU/OK** > **[Answ. Machine]** > **MENU/OK**.
- 2 Select **[Delete all]**, then press **MENU/OK** to confirm.
  - ↳ A confirmation request is displayed on the handset.
- 3 Press **MENU/OK** to confirm.
  - ↳ All old messages are permanently deleted.

### Note

- You can only delete the read messages. No deleted messages can be recovered.

## Set the ring delay

You can set the number of times the phone rings before the answering machine picks up the call.

- 1 Press  /  or **MENU/OK** > **[Answ. Machine]** > **MENU/OK**.
- 2 Select **[Ring delay]**, then press **MENU/OK** to confirm.
- 3 Select a new setting, then press **MENU/OK** to confirm.
  - ↳ The setting is saved.

### Note

- Make sure that the answering machine is switched on before this feature can be applied.

### Tip

- When you access the answering machine remotely, you are recommended to set the ring delay to **[Toll saver]** mode. This is a cost effective way to manage your messages. When there are new messages, the answering machine picks up the call after 3 rings; When there is no messages, it picks up the call after 5 rings.

## Remote access



You can operate your answering machine when you are away from home. Simply make a call to your phone with a touch tone phone and enter your 4-digit PIN code.

### Note

- The remote access PIN code is the same as your system PIN. The preset PIN is 0000.

## Activate/deactivate the remote access

You can allow or block remote access to the answering machine.

- 1 Press  /  or **MENU/OK** > **[Answ. Machine]** > **MENU/OK**.
- 2 Select **[Remote access]**, then press **MENU/OK** to confirm.
- 3 Select **[Activate]/[Deactivate]**, then press **MENU/OK** to confirm.
  - ↳ The setting is saved.

---

## Change the PIN/passcode

- 1 Press / or **MENU/OK** > [**Answ. Machine**] > **MENU/OK**.
- 2 Select [**Remote access**] > [**Change PIN**], then press **MENU/OK** to confirm.
- 3 Enter the old PIN/passcode, then press **MENU/OK** to confirm.
- 4 Enter the new PIN/passcode, then press **MENU/OK** to confirm.
- 5 Enter the new PIN/passcode again, then press **MENU/OK** to confirm.  
↳ The setting is saved.

---

## Access the answering machine remotely

- 1 Make a call to your home number with a touch tone phone.
- 2 Enter # when you hear the announcement.
- 3 Enter your PIN code.  
↳ You now have access to your answering machine, and you can now listen to the new messages.

### Note

- You have 2 chances to enter the correct PIN code before your phone hangs up.

- 4 Press a key to carry out a function. See the Remote access commands table below for a list of available functions.

### Note

- When there is no message, the phone hangs up automatically if no key is pressed for 8 seconds.

## Remote access commands

---

Key	Function
1	Listen to the previous message.
2	Listen to messages.

---

---

3	Skip to the next message.
6	Delete the current message.
7	Switch the answering machine on (not available when you listen to the messages).
8	Stop listening to the message.
9	Switch the answering machine off. (not available when you listen to the messages).

---

---

## Behavior of the LED indicator on the base station

The table below shows you the current status with different LED indicator behavior on the base station.

---

LED indicator	Message status
Steady on	You are in a call.
Flashing	<ul style="list-style-type: none"><li>• There is a new message.</li><li>• There is a new voice mail.</li><li>• There is a missed call.</li><li>• There is an incoming call.</li><li>• The system is in registration mode.</li></ul>

---



# 13 Services

The phone supports a number of features that help you handle and manage the calls.

---

## Call list type

You can set if you can see all incoming calls or only missed calls from the call log.

### Note

- This is a country dependent feature.

---

## Select the call list type

- 1 Press **MENU/OK**.
- 2 Select **[Services]** > **[Call list type]**, then press **MENU/OK** to confirm.
- 3 Select an option, then press **MENU/OK** to confirm.

---

## Auto conference

To join an external call with another handset, press .

### Note

- This feature is available only for multi-handset versions.

---

## Activate/Deactivate auto conference

- 1 Press **MENU/OK**.
- 2 Select **[Services]** > **[Conference]**, then press **MENU/OK** to confirm.
- 3 Select **[Auto]/[Off]**, then press **MENU/OK** to confirm.  
↳ The setting is saved.

---

## Call barring

You can block outgoing calls to numbers, such as overseas calls or undesirable hotlines by barring calls that start with certain digits. You can create 4 sets of numbers with 4 digits at maximum for each set of numbers. When you make a call that starts with one of these 4 sets of numbers, the outgoing call is then barred.

---

## Select the barring mode

- 1 Press **MENU/OK**.
- 2 Select **[Services]** > **[Call barring]** > **[Barring mode]**, then press **MENU/OK** to confirm.
- 3 Enter the call barring PIN/passcode. The default PIN/passcode is 0000. Then press **MENU/OK** to confirm.
- 4 Select **[On]/[Off]**, then press **MENU/OK** to confirm.  
↳ The setting is saved.

---

## Add new numbers to the barred list

- 1 Press **MENU/OK**.
- 2 Select **[Services]** > **[Call barring]** > **[Barring number]**, then press **MENU/OK** to confirm.
- 3 Enter the call barring PIN/passcode. The default PIN is 0000. Then press **MENU/OK** to confirm.
- 4 Select a number from the list, then press **MENU/OK** to confirm.
- 5 Edit the number, then press **MENU/OK** to confirm.  
↳ The setting is saved.

---

## Change the barring PIN/passcode

- 1 Press **MENU/OK**.
- 2 Select **[Services]** > **[Call barring]** > **[Change PIN]**, then press **MENU/OK** to confirm.
- 3 Enter the old barring PIN/passcode. The default PIN is 0000. Then press **MENU/OK** to confirm.
- 4 Enter the new PIN/passcode, then press **MENU/OK** to confirm.
- 5 Enter the new PIN/passcode again, then press **MENU/OK** to confirm.  
↳ The setting is saved.

---

## Blacklist

You can put numbers into the blacklist to block incoming calls to certain undesirable numbers. You can create 4 sets of numbers with 24 digits at maximum for each set of numbers. When there is an incoming call that starts with one of these 4 sets of numbers, the ringer will be muted.

### Note

- Make sure you have subscribed to the caller ID service before you use this feature.
- The contact's name in phonebook will not be displayed if this contact's number matches the record saved in the blacklist.

---

## Activate/deactivate the blacklist

- 1 Press **MENU/OK**.
- 2 Select **[Services]** > **[Blacklist]**, then press **MENU/OK** to confirm.
- 3 Select **[Blacklist mode]**, press **MENU/OK** to confirm.
- 4 Enter the PIN/passcode. The default PIN is 0000. Then press **MENU/OK** to confirm.
- 5 Select **[On]/[Off]**, then press **MENU/OK** to confirm.  
↳ The setting is saved.

---

## Add blacklist numbers

- 1 Press **MENU/OK**.
- 2 Select **[Services]** > **[Blacklist]**, then press **MENU/OK** to confirm.
- 3 Select **[Blacklist]**, then press **MENU/OK** to confirm.
- 4 Enter the PIN/passcode. The default PIN is 0000. Then press **MENU/OK** to confirm.
- 5 Enter the number, then press **MENU/OK** to confirm.  
↳ The setting is saved.

---

## Change the blacklist PIN/passcode

- 1 Press **MENU/OK**.
- 2 Select **[Services]** > **[Blacklist]** > **[Change PIN]**, then press **MENU/OK** to confirm.
- 3 Enter the old barring PIN/passcode. The default PIN is 0000. Then press **MENU/OK** to confirm.
- 4 Enter the new PIN/passcode, then press **MENU/OK** to confirm.
- 5 Enter the new PIN/passcode again, then press **MENU/OK** to confirm.  
↳ The setting is saved.

---

## Network type

### Note

- This is a country dependent feature. It only applies to models with network type support.

- 1 Press **MENU/OK**.
- 2 Select **[Services]** > **[Network type]**, then press **MENU/OK**.
- 3 Select a network type, then press **MENU/OK**.  
↳ The setting is saved.

---

## Auto prefix

This feature checks and formats your outgoing call number before it is dialed out. The prefix number can replace the detect number you set in the menu. For example, you set 604 as the detect number and 1250 as the prefix. When you have dialed out a number such as 6043338888, your phone changes the number to 12503338888 when it dials out.

### Note

- The maximum length of a detect number is 10 digits. The maximum length of an auto prefix number is 10 digits.
- This is a country dependent feature.

---

## Set auto prefix

- 1 Press **MENU/OK**.
- 2 Select **[Services]** > **[Auto prefix]**, then press **MENU/OK** to confirm.
- 3 Enter the detect number, then press **MENU/OK** to confirm.
- 4 Enter the prefix number, then press **MENU/OK** to confirm.  
↳ The setting is saved.

### Note

- To enter a pause, press and hold **#\*\*A**.
- If the prefix number is set and the detect number is left empty, the prefix number is added to all outgoing calls.
- The feature is unavailable if the dialed number starts with **\*** and **#**.

---

## Select the recall duration

Make sure that the recall time is set correctly before you can answer a second call. In normal case, the phone is already preset for the recall duration. You can select among 3 options: **[Short]**, **[Medium]** and **[Long]**. The number of available options varies with different countries. For details, consult your service provider:

- 1 Press **MENU/OK**.
- 2 Select **[Services]** > **[Recall time]**, then press **MENU/OK** to confirm.
- 3 Select an option, then press **MENU/OK** to confirm.  
↳ The setting is saved.

---

## Dial mode

### Note

- This feature only applies to models that support both tone and pulse dial.

Dial mode is the telephone signal used in your country. The phone supports tone (DTMF) and pulse (rotary) dial. Consult the service provider for detailed information.

---

## Set the dial mode

- 1 Press **MENU/OK**.
- 2 Select **[Services]** > **[Dial mode]**, then press **MENU/OK** to confirm.
- 3 Select a dial mode, then press **MENU/OK** to confirm.  
↳ The setting is saved.

### Note

- If your phone is in pulse dial mode, press **\*INT** during a call for temporary tone mode. Digits entered for this call are then sent out as tone signals.

---

## Auto clock

### Note

- This service is network dependent.
- Make sure you have subscribed to the caller ID service before you use this feature.

It synchronizes the date and time on your phone with the public switched telephone network (PSTN) automatically. For the date to be synchronized, make sure the current year is set.

- 1 Press **MENU/OK**.
- 2 Select **[Services]** > **[Auto clock]**, then press **MENU/OK** to confirm.
- 3 Select **[On]/[Off]**. Press **MENU/OK**.  
↳ The setting is saved.

---

## Register additional handsets

You can register additional handsets to the base station. The base station can register up to 4 handsets.

- 1 Press **MENU/OK** on the handset.
- 2 Select **[Services]** > **[Register]**, then press **MENU/OK** to confirm.
- 3 Press and hold **(\*)** on the base station for 5 seconds.
- 4 Enter the system PIN. Press **REDIAL/C** to make corrections. Then press **MENU/OK** to confirm the PIN.  
↳ Registration is complete in less than 2 minutes. The base automatically assigns a handset number to the handset.

### Note

- If the PIN is incorrect or no base is found within a certain period, your handset displays a notification message. Repeat the above procedure if registration fails.
- The preset PIN is 0000. No change can be made on it.

---

## Unregister the handsets

- 1 Press **MENU/OK**.
- 2 Select **[Services]** > **[Unregister]**, then press **MENU/OK** to confirm.
- 3 Enter the system PIN. (The preset PIN is 0000). Press **REDIAL/C** to remove the number.
- 4 Select the handset number to be unregistered.
- 5 Press **MENU/OK** to confirm.  
↳ The handset is unregistered.

### Tip

- The handset number is displayed beside the handset name in standby mode.

---

## Restore default settings

You can reset your phone settings to the original factory settings.

- 1 Press **MENU/OK**.
- 2 Select **[Services] > [Reset]**, then press **MENU/OK** to confirm.
  - ↳ A confirmation request is displayed on the handset.
- 3 Press **MENU/OK** to confirm.
  - ↳ All settings (except the phonebook and direct access keys information) are reset.

# 14 Technical data

## General specification and features

- Talk time: 16 hours
- Standby time: 250 hours
- Range indoor: 50 meters
- Range outdoor: 300 meters
- Phonebook list with 100 entries
- Redial list with 20 entries
- Call log with 50 entries
- Answering machine with 30 minutes recording time
- Caller identification standard support: FSK, DTMF

## Battery

- Philips: 2 × AAA Ni-MH 1.2V 550 mAh rechargeable batteries

## Power adapter

### Base

- Tenpao: S003EB06000302, input: 100-240 V~, 50/60 Hz 200 mA, output: (i) 6Vdc 300 mA; (ii) 6 Vdc 200 mA

### Charger

- Tenpao: S003GB0600050, Input: 100-240Vac 50/60Hz 150mA; Output: 6Vdc 500mA

## Power consumption

- Power consumption in idle mode: around 1.35 W (M660); 1.40 W (M665)

## Weight and dimensions

- Handset: 108 grams  
179.9 × 48.2 × 45.7 mm (H × W × D)
- Base: 165 grams  
206.1 × 89.7 × 81.8 mm (H × W × D)
- Charger: 155 grams  
206.1 × 89.7 × 81.8 mm (H × W × D)

# 15 Notice

## Declaration of conformity

Hereby, Gibson Innovations declares that this product is in compliance with the essential requirements and other relevant provisions of Directive 1999/5/EC. You can find the Declaration of Conformity on [www.p4c.philips.com](http://www.p4c.philips.com).

## Use GAP standard compliance

The GAP standard guarantees that all DECT™ GAP handsets and base stations comply with a minimum operating standard irrespective of their make. The handset and base station are GAP compliant, which means they guarantee the minimum functions: register a handset, take the line, make a call and receive a call. The advanced features may not be available if you use them with other makes. To register and use this handset with a GAP compliant base station of different make, first follow the procedure described in the manufacturer's instructions, then follow the procedure described in this manual for registering a handset. To register a handset from different make to the base station, put the base station in registration mode, then follow the procedure described in the handset manufacturer's instructions.

## Compliance with EMF

This product complies with all applicable standards and regulations regarding exposure to electromagnetic fields.

## Disposal of your old product and battery



Your product is designed and manufactured with high quality materials and components, which can be recycled and reused.



This symbol on a product means that the product is covered by European Directive 2012/19/EU.



This symbol means that the product contains batteries covered by European Directive 2013/56/EU which cannot be disposed of with normal household waste.

Inform yourself about the local separate collection system for electrical and electronic products and batteries. Follow local rules and never dispose of the product and batteries with normal household waste. Correct disposal of old products and batteries helps prevent negative consequences for the environment and human health.

### Removing the disposable batteries

To remove the disposable batteries, see the chapter "Frequently asked questions".



When this logo is attached to a product, it means a financial contribution has been paid to the associated national recovery and recycling system.

### Environmental information

All unnecessary packaging has been omitted. We have tried to make the packaging easy to separate into three materials: cardboard (box),

polystyrene foam (buffer) and polyethylene (bags, protective foam sheet.)

Your system consists of materials which can be recycled and reused if disassembled by a specialized company. Please observe the local regulations regarding the disposal of packaging materials, exhausted batteries and old equipment.



# 16 Frequently asked questions

## No signal bar is displayed on the screen.

- The handset is out of range. Move it closer to the base station.
- If the handset displays **[Register your Handset]**, register your handset.

### Tip

- For further information, see the chapter 'Services', section 'Register additional handsets'.

## If I fail to pair (register) the additional handsets to the base station, what do I do?

Your base memory is full. Unregister the unused handsets and try again.

### Tip

- For further information, see the chapter 'Services', section 'Unregister the handsets'.

## My handset is in searching status, what do I do?

- Make sure that the base station has power supply.
- Register the handset to the base station.
- Move the handset closer to the base station.

## I have chosen a wrong language which I cannot read, what do I do?

- 1 Press  to go back to the standby screen.
- 2 Press **MENU/OK** to access the main menu screen.
- 3 One of the following texts appears on the screen:

---

Réglages > Langue

Phone setup > Language

---

Config. telef. > Lingua

---

**4** Select it to access the language options.

**5** Select your own language.

## The handset loses connection with the base or the sound is distorted during a call.

Check if the **ECO+** mode is activated. Turn it off to increase the handset range and enjoy the optimal call conditions.

### No dialing tone.

- Check your phone connections.
- The handset is out of range. Move it closer to the base station.

### No docking tone.

- The handset is not placed properly on the base station/charger.
- The charging contacts are dirty. Disconnect the power supply first and clean the contacts with a damp cloth.

## I cannot change the settings of my voice mail, what do I do?

The voice mail service is managed by your service provider but not the phone itself.

Contact your service provider to change the settings.

## The handset on the charger does not charge.

- Make sure the batteries are inserted correctly.
- Make sure the docking tone setting is turned on. When the handset is placed correctly on the charger, you can hear a docking tone.
- The charging contacts are dirty. Disconnect the power supply first and clean the contacts with a damp cloth.
- Batteries are defective. Purchase new ones with the same specifications. To remove the battery door, refer to the instruction in the following picture.

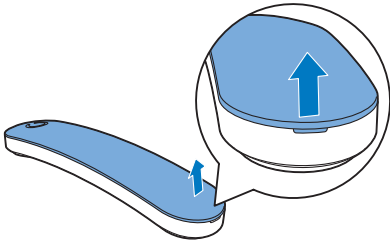

**No display.**

- Make sure the batteries are charged.
- Make sure there is power and the phone is connected.

**Bad audio (crackles, echo, etc.).**

- The handset is nearly out of range. Move it closer to the base station.
- The phone receives interference from the nearby electrical appliances. Move the base station away from them.
- The phone is at a location with thick walls. Move the base away from them.

**The handset does not ring.**

Make sure the handset ringtone is turned on.

**The caller ID does not display.**

- The service is not activated. Check with your service provider.
- The caller's information is withheld or unavailable.

 **Note**

- If the above solutions do not help, disconnect the power supply from both the handset and base station. Try again after 1 minute.

# 17 Appendix

## Text and number input tables

Key Upper case characters (for English/  
French/ German/ Italian/Turkish/  
Portuguese/Spanish/Dutch/Danish/  
Finnish/Norwegian/ Swedish/Romanian/  
Polish/Czech/Hungarian/Slovakian/  
Slovenian/Croatian/Lithuanian/Estonian/  
Latvian/Bulgarian)

0	Space . 0 , / ; " ' ! ; ? ; * + - % \ ^ ~
1	1 @ _ # = < > ( ) & € £ \$ ¥ [ ] { } ¤ § ...
2	A B C 2 Å Ä Æ Á Ā Ą Ą Ą Ą Ą Ą Ç Ć
3	D E F 3 È É Ê Ë Ę Ę Ę Ę Δ Φ
4	G H I 4 Ğ Ĩ İ Ĵ Ŀ Γ
5	J K L 5 Λ
6	M N O 6 Ñ Ó Ô Õ Ö
7	P Q R S 7 Š Œ Π Θ Σ
8	T U V 8 Û Ü Ŭ Ū Ŭ Ŭ
9	W X Y Z 9 Ø Æ Ξ Ψ Ž

Key Lower case characters (for English/  
French/ German/ Italian/Turkish/  
Portuguese/Spanish/Dutch/Danish/  
Finnish/Norwegian/Swedish)

0	Space . 0 , / ; " ' ! ; ? ; * + - % \ ^ ~
1	1 @ _ # = < > ( ) & € £ \$ ¥ [ ] { } ¤ § ...
2	a b c 2 à â ä æ á ā ą ą ą ą ā ç ĉ
3	d e f 3 è é ê ë è ě ē Δ Φ
4	g h i 4 ğ ĩ ĵ ĵ Ĵ Γ
5	j k l 5 λ
6	m n o 6 ñ ó ô õ ö ò
7	p q r s 7 š Œ Π Θ Σ
8	t u v 8 ù ü ŭ ŭ ŭ ŭ
9	w x y z 9 ø æ Ξ Ψ ž

Key Upper case characters (for Greek)

0	Space . 0 , / ; " ' ! ; ? ; * + - % \ ^ ~
1	1 @ _ # = < > ( ) & € £ \$ ¥ [ ] { } ¤ § ...

2	A Β Γ 2 A B C Æ Å Ä Ç
3	Δ Ε Ζ 3 D E F Ε
4	H Θ Ι 4 G H I
5	K Λ Μ 5 J K L
6	N Ξ Ο 6 M N O Ñ Ö
7	Π Ρ Σ 7 P Q R S
8	T Υ Φ 8 T U V Ü
9	X Ψ Ω 9 W X Y Z Ø

Key Lower case characters (for Greek)

0	Space . 0 , / ; " ' ! ; ? ; * + - % \ ^ ~
1	1 @ _ # = < > ( ) & € £ \$ ¥ [ ] { } ¤ § ...
2	α β γ 2 a b c à æ ä å
3	δ ε ζ 3 d e f è é
4	η θ ι 4 g h i ï
5	κ λ μ 5 j k l λ
6	ν ξ ο 6 m n o ñ ö ò
7	π ρ σ ζ 7 p q r s β
8	τ υ φ 8 t u v ü ü
9	χ ψ ω 9 w x y z ø

Key Upper case characters (for Serbian)

0	Space . 0 , / ; " ' ! ; ? ; * + - % \ ^ ~
1	1 @ _ # = < > ( ) & € £ \$ ¥ [ ] { } ¤ § ...
2	A B C Ђ Ć Č 2 A B В Г
3	D E F Ј Đ 3 Δ E Ж 3 Δ Ф
4	G H I Љ 4 И Й К Л Г
5	J K L Њ 5 M H O П Л
6	M N O Т Ђ Р C T Y
7	P Q R S Ж Š 7 Ф X Ц Ч П Θ Σ Β
8	T U V 8 Ш Щ Ъ Ы
9	W X Y Z Ž 9 Ь Э Ю Я Ω Ξ Ψ

Key Lower case characters (for Serbian)

0	Space . 0 , / ; " ' ! ; ? ; * + - % \ ^ ~
1	1 @ _ # = < > ( ) & € £ \$ ¥ [ ] { } ¤ § ...
2	a b c Ђ Ć Č 2 A B В Г
3	d e f Ј Đ 3 Δ E Ж 3
4	g h i Љ 4 И Й К Л
5	j k l Њ 5 M H O П

6	mno Ħ 6 PCTY
7	p q r s Ж Š 7 Ф X Ц Ч П Θ Σ Β
8	t u v L j 8 Ш Щ Ъ Ы
9	w x y z Ž 9 Ь Э Ю Я Ω Ξ Ψ

# 18 Index

---

## A

additional handsets	33
alarm	25
announcements	27
answer a call	11
answering machine	26
auto answer	23
auto clock	33
auto conference	30
auto hang up	23
auto prefix	32

---

## B

base station	
installation	7
overview	6
battery	7, 9, 34
blacklist	31

---

## C

call barring	30
call log	18
caller ID	11, 18
calling	11
charging	9
conference call	13, 30
contacts	16

---

## D

date setting	8, 33
default settings	33
delete messages	28
dial mode	32
display icons	9
disposal	35

---

## E

ECO mode	22
ECO+ mode	22

---

## F

family note	26
find handsets/paging	6

---

## G

GAP	35
-----	----

---

## I

incoming message	27
intercom	13
internal call	13

---

## L

language setting	
handset	8, 23
LED behavior	29
listen to messages	28

---

## M

missed calls	18
mute	12

---

## N

name the handset	23
network type	31

---

## P

phone settings	21
phonebook	16, 18, 20
PIN	
answering machine	9
blacklist	31
call barring	30
power adapter	34

---

## R

recall time	32
redial	20
register/unregister	33
remote access to the answering machine	9
ringtone	21

---

## S

safety	3
save a number	18, 20
signal strength	10
silent mode	21
sounds	
docking	21
keytone	21
sound profile	22
speaker phone	12
standby mode	9

---

## T

text entry	15
time setting	33
troubleshooting/FAQ	37

---

## V

volume adjustment	12
-------------------	----



2016 © Gibson Innovations Limited. All rights reserved.  
This product has been manufactured by, and is sold  
under the responsibility of Gibson Innovations Ltd., and  
Gibson Innovations Ltd. is the warrantor in relation to  
this product.

Philips and the Philips Shield Emblem are  
registered trademarks of Koninklijke Philips  
N.V. and are used under license from  
Koninklijke Philips N.V.

UM\_M660\_665\_05\_EN\_V3.0  
wk1617

**CE 0168**

