

Register your product and get support at
www.philips.com/welcome

PET7402
PET7402S



Thank you for choosing Philips.

Need help fast?

Read your Quick Start Guide and/or User Manual first for quick tips that make using your Philips product more enjoyable.

If you have read your instructions and still need assistance, you may access our online help at

www.philips.com/welcome
or call

1-888-PHILIPS (744-5477)
while with your product.

(and Model / Serial number)



Philips vous remercie de
votre confiance.

Besoin d'une aide rapide?

Le Guide rapide de début et Manuel de l'utilisateur regorgent d'astuces destinées à simplifier l'utilisation de votre produit Philips. Toutefois, si vous ne parvenez pas à résoudre votre problème, vous pouvez accéder à notre aide en ligne à l'adresse

www.philips.com/welcome
ou formez le

1-800-661-6162 (Francophone)
1-888-PHILIPS (744-5477) (English speaking)

Veillez à avoir votre produit à
portée de main.
(et model / serial nombre)



Gracias por escoger Philips

Necesita ayuda inmediata?

Lea primero la Guía rápida del comienzo o el Manual del usuario, en donde encontrará consejos que le ayudarán a disfrutar plenamente de su producto Philips.

Si después de leerlo aún necesita ayuda, consulte nuestro servicio de asistencia en línea en

www.philips.com/welcome
o llame al teléfono

1-888-PHILIPS (744-5477)
y tenga a mano el producto.
(y número de model / serial)



EN User manual

ES Manual del usuario

FR Mode d'emploi

PHILIPS

Canada

English:

This digital apparatus does not exceed the Class B limits for radio noise emissions from digital apparatus as set out in the Radio Interference Regulations of the Canadian Department of Communications. This Class B digital apparatus complies with Canadian ICES-003.

Français:

Cet appareil numérique n'émet pas de bruits radioélectriques dépassant les limites applicables aux appareils numériques de Classe B prescrites dans le Règlement sur le Brouillage Radioélectrique édicté par le Ministère des Communications du Canada. Cet appareil numérique de la classe B est conforme à la norme NMB-003 du Canada.

The set complies with the FCC-Rules, Part 15 and with 21 CFR 1040.10. Operation is subject to the following two conditions:

1. This device may not cause harmful interference, and
2. This device must accept any interference received, including interference that may cause undesired operation.

L'appareil est conforme à la réglementation FCC, section 15, et à la norme 21 CFR 1040.10. Son utilisation est soumise à deux conditions :

1. L'appareil ne doit pas provoquer d'interférences nuisibles, et
2. L'appareil doit supporter les interférences reçues, y compris les interférences empêchant son fonctionnement correct.

NOTE: This equipment has been tested and found to comply with the limits for a Class B digital device, pursuant to Part 15 of the FCC Rules. These limits are designed to provide reasonable protection against harmful interference in a residential installation. This equipment generates, uses and can radiate radio frequency energy and, if not installed and used in accordance with the instructions, may cause harmful interference to radio communications.

However, there is no guarantee that interference will not occur in a particular installation. If this equipment does cause harmful interference to radio or television reception, which can be determined by turning the equipment off and on, the user is encouraged to try to correct the interference by one or more of the following measures:

- Reorient or relocate the receiving antenna.
- Increase the separation between the equipment and receiver.
- Connect the equipment into an outlet on a circuit different from that to which the receiver is connected.
- Consult the dealer or an experienced radio/TV technician for help.

Contents

1	Important	6
	Important safety instructions	6
	Notice	8
<hr/>		
2	Your portable DVD player	10
	Introduction	10
	What's in the box	10
	Overview of the main unit	11
	Overview of the second screen	13
<hr/>		
3	Get started	14
	Preparation	14
	Connect the second screen	15
	Connect power	16
<hr/>		
4	Use your player	17
	Turn on	17
	Select OSD language	17
	Play discs	17
	Play options	18
<hr/>		
5	Adjust settings	19
	Set the main unit	19
	Set the second screen	20
<hr/>		
6	Use more of your player	21
	Connect additional equipment	21
	Connect power from household source	22
<hr/>		
7	Product information	23
<hr/>		
8	Troubleshooting	24

Return your Product Registration Card or register online at
www.philips.com/welcome today to get the very most from your purchase.

Registering your model with PHILIPS makes you eligible for all of the valuable benefits listed below, so don't miss out. Complete and return your Product Registration Card at once, **or register online at www.philips.com/welcome** to ensure:

*Proof of Purchase

Returning the enclosed card guarantees that your date of purchase will be on file, so no additional paperwork will be required from you to obtain warranty service.

*Product Safety Notification

By registering your product, you'll receive notification - directly from the manufacturer - in the rare case of a product recall or safety defect.

*Additional Benefits

Registering your product guarantees that you'll receive all of the privileges to which you're entitled, including special money-saving offers.

PHILIPS

Congratulations on your purchase, and welcome to the "family!"

Dear PHILIPS product owner:

Thank you for your confidence in PHILIPS. You've selected one of the best-built, best-backed products available today. We'll do everything in our power to keep you happy with your purchase for many years to come.

As a member of the PHILIPS "family," you're entitled to protection by one of the most comprehensive warranties and outstanding service networks in the industry. What's more, your purchase guarantees you'll receive all the information and special offers for which you qualify, plus easy access to accessories from our convenient home shopping network.

Most importantly, you can count on our uncompromising commitment to your total satisfaction.

All of this is our way of saying welcome - and thanks for investing in a PHILIPS product.

P.S. To get the most from your PHILIPS purchase, be sure to complete and return your Product Registration Card at once, or register online at:

www.philips.com/welcome

Know these
safety symbols



 This "bolt of lightning" indicates uninsulated material within your unit may cause an electrical shock. For the safety of everyone in your household, please do not remove product covering.

 The "exclamation point" calls attention to features for which you should read the enclosed literature closely to prevent operating and maintenance problems.

WARNING: To reduce the risk of fire or electric shock, this apparatus should not be exposed to rain or moisture and objects filled with liquids, such as vases, should not be placed on this apparatus.

CAUTION: To prevent electric shock, match wide blade of plug to wide slot, fully insert.

ATTENTION: Pour éviter les choc électriques, introduire la lame la plus large de la fiche dans la borne correspondante de la prise et pousser jusqu'au fond.

For Customer Use

Enter below the Serial No. which is located on the rear of the cabinet. Retain this information for future reference.

Model No. _____

Serial No. _____

PHILIPS

Visit our World Wide Web Site at <http://www.philips.com/welcome>

PHILIPS LIMITED WARRANTY ONE (1) YEAR

WARRANTY COVERAGE:

PHILIPS warranty obligation is limited to the terms set forth below.

WHO IS COVERED:

Philips warrants the product to the original purchaser or the person receiving the product as a gift against defects in materials and workmanship as based on the date of original purchase ("Warranty Period") from an Authorized Dealer. The original sales receipt showing the product name and the purchase date from an authorized retailer is considered such proof.

WHAT IS COVERED:

The Philips warranty covers new products if a defect in material or workmanship occurs and a valid claim is received by Philips within the Warranty Period. At its option, Philips will either (1) repair the product at no charge, using new or refurbished replacement parts, or (2) exchange the product with a product that is new or which has been manufactured from new, or serviceable used parts and is at least functionally equivalent or most comparable to the original product in Philips current inventory, or (3) refund the original purchase price of the product. Philips warrants replacement products or parts provided under this warranty against defects in materials and workmanship from the date of the replacement or repair for ninety (90) days or for the remaining portion of the original product's warranty, whichever provides longer coverage for you. When a product or part is exchanged, any replacement item becomes your property and the replaced item becomes Philips' property. When a refund is given, your product becomes Philips' property.

Note: Any product sold and identified as refurbished or renewed carries a ninety (90) day limited warranty.

Replacement product can only be sent if all warranty requirements are met. Failure to follow all requirements can result in delay.

WHAT IS NOT COVERED - EXCLUSIONS AND LIMITATIONS:

This Limited Warranty applies only to the new products manufactured by or for Philips that can be identified by the trademark, trade name, or logo affixed to it. This Limited Warranty does not apply to any non-Philips hardware product or any software, even if packaged or sold with the product. Non-Philips manufacturers, suppliers, or publishers may provide a separate warranty for their own products packaged with the bundled product.

Philips is not liable for any damage to or loss of any programs, data, or other information stored on any media contained within the product, or any non-Philips product or part not covered by this warranty. Recovery or reinstallation of programs, data or other information is not covered under this Limited Warranty.

This warranty does not apply (a) to damage caused by accident, abuse, misuse, neglect, misapplication, or non-Philips product, (b) to damage caused by service performed by anyone other than Philips or Philips Authorized Service Location, (c) to a product or a part that has been modified without the written permission of

Philips, or (d) if any Philips serial number has been removed or defaced, or (e) product, accessories or consumables sold "AS IS" without warranty of any kind by including refurbished Philips product sold "AS IS" by some retailers.

This Limited Warranty does not cover:

- Shipping charges to return defective product to Philips.
- Labor charges for installation or setup of the product, adjustment of customer controls on the product, and installation or repair of antenna/signal source systems outside of the product.
- Product repair and/or part replacement because of improper installation or maintenance, connections to improper voltage supply, power line surge, lightning damage, retained images or screen markings resulting from viewing fixed stationary content for extended periods, product cosmetic appearance items due to normal wear and tear, unauthorized repair or other cause not within the control of Philips.
- Damage or claims for products not being available for use, or for lost data or lost software.
- Damage from mishandled shipments or transit accidents when returning product to Philips.
- A product that requires modification or adaptation to enable it to operate in any country other than the country for which it was designed, manufactured, approved and/or authorized, or repair of products damaged by these modifications.
- A product used for commercial or institutional purposes (including but not limited to rental purposes).
- Product lost in shipment and no signature verification receipt can be provided.
- Failure to operate per Owner's Manual.

TO OBTAIN ASSISTANCE IN THE U.S.A., PUERTO RICO, OR U.S. VIRGIN ISLANDS...

Contact Philips Customer Care Center at:
1-888-PHILIPS (1-888-744-5477)

TO OBTAIN ASSISTANCE IN CANADA...

1-800-661-6162 (French Speaking)
1-888-PHILIPS (1-888-744-5477) - (English or Spanish Speaking)

REPAIR OR REPLACEMENT AS PROVIDED UNDER THIS WARRANTY IS THE EXCLUSIVE REMEDY FOR THE CONSUMER. PHILIPS SHALL NOT BE LIABLE FOR ANY INCIDENTAL OR CONSEQUENTIAL DAMAGES FOR BREACH OF ANY EXPRESS OR IMPLIED WARRANTY ON THIS PRODUCT. EXCEPT TO THE EXTENT PROHIBITED BY APPLICABLE LAW, ANY IMPLIED WARRANTY OF MERCHANTABILITY OR FITNESS FOR A PARTICULAR PURPOSE ON THIS PRODUCT IS LIMITED IN DURATION TO THE DURATION OF THIS WARRANTY.

Some states do not allow the exclusions or limitation of incidental or consequential damages, or allow limitations on how long an implied warranty lasts, so the above limitations or exclusions may not apply to you.

This warranty gives you specific legal rights. You may have other rights which vary from state/province to state/province.

Philips, P.O. Box 671539, Marietta, GA. 30006-0026

3121 233 48802

1 Important

Important safety instructions

- ① Read these instructions.
- ② Keep these instructions.
- ③ Heed all warnings.
- ④ Follow all instructions.
- ⑤ Do not use this apparatus near water.
- ⑥ Clean only with dry cloth.
- ⑦ Do not block any ventilation openings. Install in accordance with the manufacturer's instructions.
- ⑧ Do not install near any heat sources such as radiators, heat registers, stoves, or other apparatus (including amplifiers) that produce heat.
- ⑨ For countries with a polarized mains, do not defeat the safety purpose of the polarized or grounding-type plug. A polarized plug has two blades with one wider than the other. A grounding type plug has two blades and a third grounding prong. The wide blade or the third prong are provided for your safety. If the provided plug does not fit into your outlet, consult an electrician for replacement of the obsolete outlet.
Caution: To prevent electric shock, match the wide blade of the plug to the wide slot, fully insert.
- ⑩ Protect the power cord from being walked on or pinched, particularly at plugs, convenience receptacles, and the point where they exit from the apparatus.
- ⑪ Only use attachments/accessories specified by the manufacturer.
- ⑫ Use only with the cart, stand, tripod, bracket, or table specified by the manufacturer or sold with the apparatus. When a cart is used, use caution when moving the cart/apparatus combination to avoid injury from tip-over.
- ⑬ Unplug this apparatus during lightning storms or when unused for long periods of time.

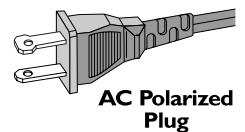

- ⑭ Refer all servicing to qualified service personnel. Servicing is required when the apparatus has been damaged in any way, such as power-supply cord or plug is damaged, liquid has been spilled or objects have fallen into the apparatus, the apparatus has been exposed to rain or moisture, does not operate normally, or has been dropped.
- ⑮ Apparatus shall not be exposed to dripping or splashing.
- ⑯ Do not place any sources of danger on the apparatus (e.g. liquid filled objects, lighted candles).
- ⑰ This product may contain lead and mercury. Disposal of these materials may be regulated due to environmental considerations. For disposal or recycling information, please contact your local authorities or the Electronic Industries Alliance: www.eiae.org.



Warning

- Never remove the casing of this apparatus.
- Never lubricate any part of this apparatus.
- Never place this apparatus on other electrical equipment.
- Keep this apparatus away from direct sunlight, naked flames or heat.
- Never look into the laser beam inside this apparatus.
- Ensure that you always have easy access to the power cord, plug or adaptor to disconnect this apparatus from the power.

Hearing safety

Listen at a moderate volume.

- Using headphones at a high volume can impair your hearing. This product can produce sounds in decibel ranges that may cause hearing loss for a normal person, even for exposure less than a minute. The higher decibel ranges are offered for those that may have already experienced some hearing loss.
- Sound can be deceiving. Over time your hearing 'comfort level' adapts to higher volumes of sound. So after prolonged listening, what sounds 'normal' can actually be loud and harmful to your hearing. To guard against this, set your volume to a safe level before your hearing adapts and leave it there.

To establish a safe volume level:

- Set your volume control at a low setting.
- Slowly increase the sound until you can hear it comfortably and clearly, without distortion.

Listen for reasonable periods of time:

- Prolonged exposure to sound, even at normally 'safe' levels, can also cause hearing loss.
- Be sure to use your equipment reasonably and take appropriate breaks.

Be sure to observe the following guidelines when using your headphones.

- Listen at reasonable volumes for reasonable periods of time.
- Be careful not to adjust the volume as your hearing adapts.
- Do not turn up the volume so high that you can't hear what's around you.
- You should use caution or temporarily discontinue use in potentially hazardous situations. Do not use headphones while operating a motorized vehicle, cycling, skateboarding, etc.; it may create a traffic hazard and is illegal in many areas.

Notice

Environmental information

All unnecessary packaging has been omitted. We have tried to make the packaging easy to separate into three materials: cardboard (box), polystyrene foam (buffer) and polyethylene (bags, protective foam sheet.)

Your system consists of materials which can be recycled and reused if disassembled by a specialized company. Please observe the local regulations regarding the disposal of packaging materials, exhausted batteries and old equipment.

Any changes or modifications made to this device that are not expressly approved by Philips Consumer Lifestyle may void the user's authority to operate the equipment.

Recycling

Your product is designed and manufactured with high quality materials and components, which can be recycled and reused.

When you see the crossed-out wheel bin symbol attached to a product, it means the product is covered by the European Directive 2002/96/EC:

Never dispose of your product with other household waste. Please inform yourself about the local rules on the separate collection of electrical and electronic products. The correct disposal of your old product helps prevent potentially negative consequences on the environment and human health.

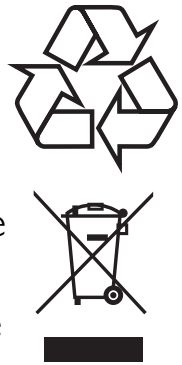

The making of unauthorized copies of copy-protected material, including computer programs, files, broadcasts and sound recordings, may be an infringement of copyrights and constitute a criminal offence. This equipment should not be used for such purposes.



Recording and playback of material might require consent. See Copyright Act 1956 and The Performer's Protection Acts 1958 to 1972.

This apparatus includes this label:



2 Your portable DVD player

Congratulations on your purchase, and welcome to Philips! To fully benefit from the support that Philips offers, register your product at www.philips.com/welcome.

Introduction

Your portable DVD player plays digital video discs that conform to the universal DVD Video standard. With it, you can play movies with true cinema picture quality and stereo or multi-channel sound (depending on disc and playback set-up).

You can also select sound track, subtitle languages, and different angle of view (again depending on DVD disc). Besides, you can restrict the play of discs that are not suitable for children.

You can play the following discs on the DVD player (including CD-R, CD-RW, DVD±R and DVD±RW):

- DVD-Video
- Video CD
- Audio CD
- MP3 CD
- Discs with JPEG files

What's in the box

Check and identify the contents of your package:

- Main unit x 1
- Second screen x 1
- AC power adaptor x 1, DSA-9W-09 F (DVE) or AY4132 (Philips)
- Car adaptor x 1
- AV cable x 2
- Fastening strap x 2
- User Manual x 1
- Quick Start Guide x 1

Overview of the main unit

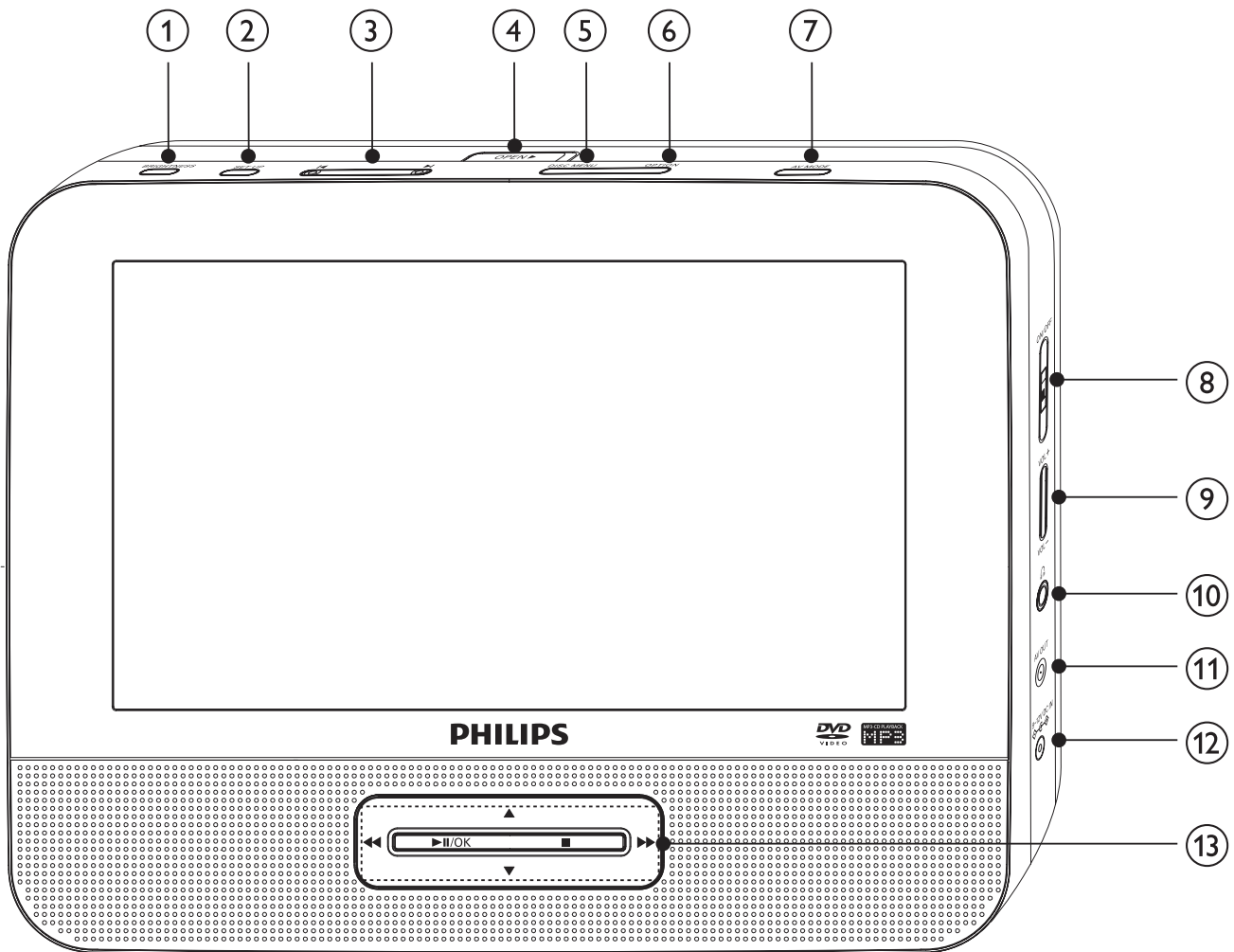

- ① **BRIGHTNESS**
 - Adjusts screen brightness.
- ② **SETUP**
 - Accesses or exits the setup menu.
- ③ **⏮, ⏭**
 - Skips to the previous or next title, chapter, or track.
- ④ **OPEN ►**
 - Opens the disc compartment.
- ⑤ **DISC MENU**
 - For DVD, accesses or exits disc menu.
 - For VCD, turns on or off PBC (Playback Control) mode.
 - For VCD version 2.0 or SVCD with PBC turned on, returns to the menu.

- ⑥ **OPTION**
 - Accesses options relating to the current activity or selection.
- ⑦ **AV MODE**
 - Turns off the front panel display when the player is connected to TV.
- ⑧ **ON/OFF**
 - Turns on/off DVD player.
- ⑨ **VOL +/-**
 - Increases or decreases volume.
- ⑩ 
 - Headphone jack.
- ⑪ **AV OUT**
 - Audio/video output jack.
- ⑫ **DC IN**
 - Power supply socket.
- ⑬ **▲, ▼, ◀◀, ▶▶**
 - Navigates through the menus.
- ◀◀, ▶▶**
 - Searches backward/forward at different speeds.
- ▶||/OK**
 - Confirms an entry or selection.
 - Starts, pauses or resumes disc play.
- - Stops disc play.

Overview of the second screen

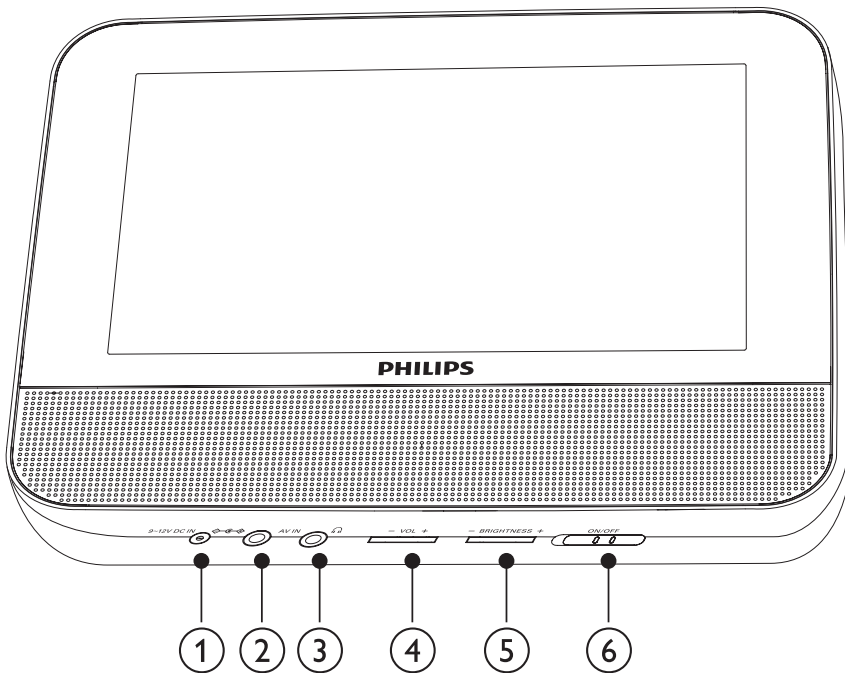

- ① **DC IN**
 - Power supply socket.
- ② **AV IN**
 - Audio/video input jack.
- ③ 
 - Headphone jack.
- ④ **VOL -/+**
 - Decreases or increases volume.
- ⑤ **BRIGHTNESS -/+**
 - Adjusts screen brightness.
- ⑥ **OFF/ON**
 - Turns off/on the second screen.

3 Get started



Caution

- Use the controls only as stated in this user manual.
- Always follow the instructions in this chapter in sequence.

If you contact Philips, you will be asked for the model and serial number of your apparatus. The model number and serial number are on the back of the apparatus. Write the numbers here:

Model No. _____

Serial No. _____

Preparation

To use the player in a car, attach the main unit and the second screen to the back of the front seat headrests.

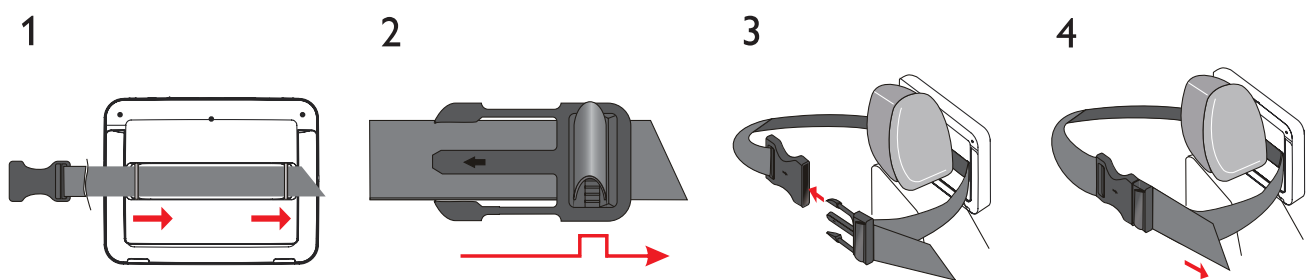

- 1 Pull the strap through the loops on the back of the main unit.
- 2 Hold the buckle with the marked arrow facing you, then attach the buckle to the strap.
- 3 Position the main unit at the back of the headrest, then fasten the buckle.
- 4 Pull the strap to secure the main unit to the headrest.
 - To attach the second screen, repeat the above steps.

Connect the second screen



Caution

- Turn off your player before you connect the second screen.

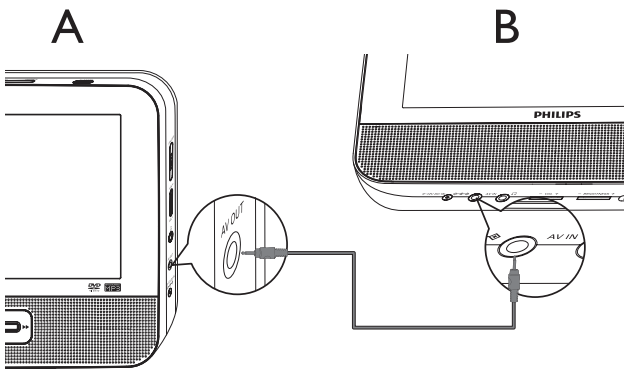

A: main unit; B: second screen

- 1 Connect the supplied AV cable to:
 - the **AV OUT** jack on the main unit.
 - the **AV IN** jack on the second screen.

Connect power



Caution

- Risk of product damage! Ensure that the power supply voltage corresponds to the voltage pointed on the back or the underside of the player.
- Risk of electric shock! When you unplug the AC adapter, always pull the plug from the socket. Never pull the cable.

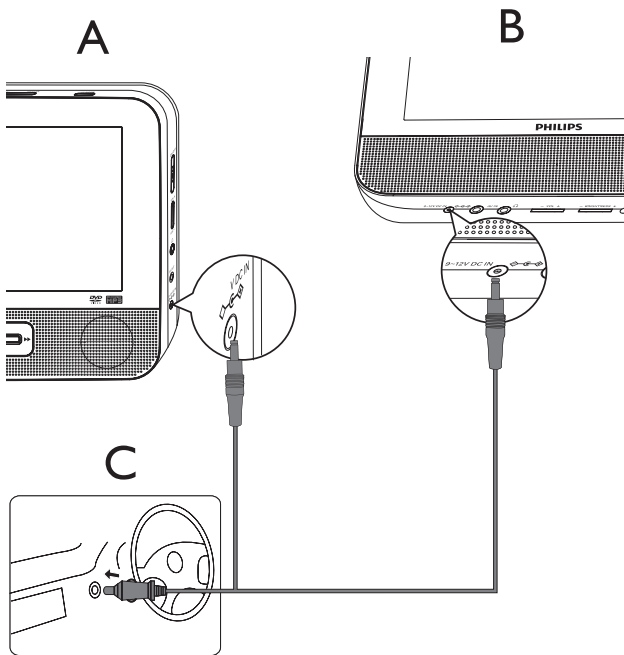

A: main unit; B: second screen; C: car cigarette lighter

- 1 Connect one end of the double-connector end of the AC cable to the **DC IN** jack on the main unit.
- 2 Connect the other end of the double-connector end of the AC cable to the **DC IN** jack on the second screen.
- 3 Connect the one-connector end to the car cigarette lighter socket.

4 Use your player

Turn on

- Slide the **ON/OFF** switch on the main unit to the **ON** position.
 - To turn on the second screen, slide the **OFF/ON** switch on the second screen to the **ON** position.

Select OSD language

You can choose a different language for the on-screen display text.

- Press **SETUP**.
 - The setup menu appears.



- Select **[-- General Setup Page --] > [OSD Language]**.
- Press **▶▶** to select an option.
- Press **▶||/OK** to confirm.
- Press **SETUP** to exit.

Play discs

- Slide **OPEN▶** on the main unit.
- Insert the disc with label side facing up.
- Push down to close the disc compartment.
 - Play starts automatically. If not, press **▶||/OK**.
 - If a menu appears, select an item, then press **▶||/OK** to start play.
 - To pause, press **▶||/OK**. Press again to resume play.
 - To stop, press **■** twice.

- To select the previous/next item, press ◀ or ▶.
 - To start search within video/audio, press ◀◀ or ▶▶ once or more.
-

Play options

1 During play, press **OPTION** to select some play options.

For DVD

- **[Audio]**
- **[Subtitle]**
- **[Repeat]**
- **[Time Disp.]**

For VCD

- **[Audio]**
- **[Repeat]**
- **[Time Disp.]**

For audio CDs

- **[Repeat One]**
- **[Repeat Folder]**
- **[Repeat Off]**

For JPEG CDs

- **[Repeat One]**
- **[Repeat Folder]**

2 Follow the on-screen instructions.

5 Adjust settings

Set the main unit

To maximize your play experience, use **SETUP** to fine tune your settings.

- 1 Press **SETUP**.
↳ The setup menu is displayed.
- 2 Press **▲▼** to select an option and press **▶II/OK** to confirm.

[-- General Setup Page --]	
[OSD Language]	Select on-screen display language.
[Screen Saver]	Activate/deactivate screen saver.
[Resume]	Select whether to start play from the point where it was last stopped.
[Angle Mark]	select angle mark display options.
[-- Display Setup Page --]	
[Brightness]	Adjust screen brightness.
[Contrast]	Adjust screen contrast.
[Screen Display]	Select display ratio.
[-- Password --]	
[Password]	Change password (3308 by default).
[-- Preference Page --]	
[Audio]	Select audio language.
[Subtitle]	Select subtitle language.
[Disc Menu]	Select disc menu language.
[Parental]	Select parental level.
[Default]	Restore original settings.

- 3 Press **◀◀** to go back to previous menu level.
- 4 Press **SETUP** to exit.

Set the second screen

You can also set the second screen.

- To adjust volume level for the second screen, rotate **VOL -/+** on the second screen.
- To adjust the brightness of the second screen, rotate **BRIGHTNESS -/+** on the second screen.

6 Use more of your player

Connect additional equipment



Caution

- Turn off your player before connecting to any additional equipment.

You can connect the player to a TV or an amplifier to enjoy DVDs or Karaoke.

Match the color of the AV cables (the AV cable connected to TV is not supplied) with the jacks: the yellow cable is for the yellow video jack, the red/white cable is for the red/white audio jacks.

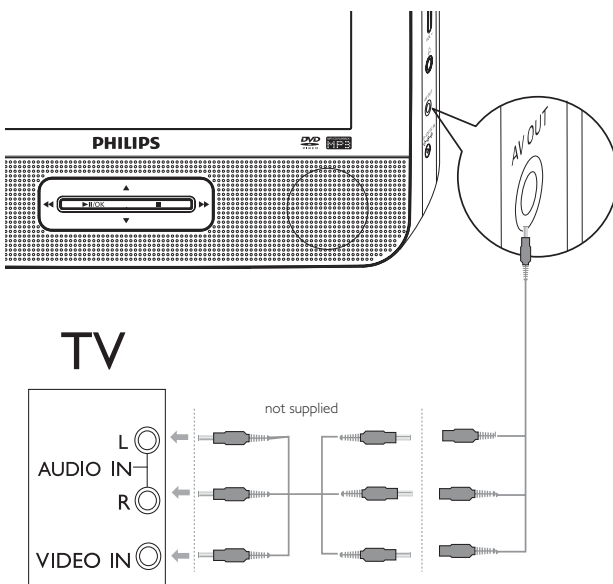

Tip

- To conserve energy, press **AV MODE** to turn off the front panel display.

Connect power from household source



Caution

- Risk of product damage! Ensure that the power supply voltage corresponds to the voltage pointed on the back or the underside of the player.
- Risk of electric shock! When you unplug the AC adaptor, always pull the plug from the socket. Never pull the cable.

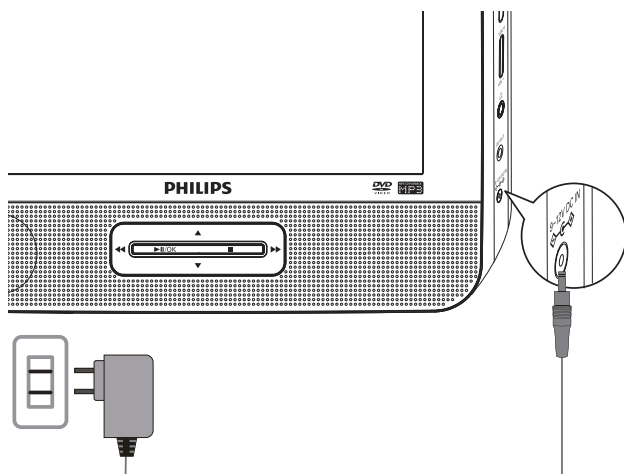

- 1 Connect the AC adaptor cable to:
 - the **DC IN** jack on the main unit.
 - the power outlet.

7 Product information



Note

- Product information is subject to change without prior notice.

Dimensions	
- Main unit	200 × 155 × 39 mm
- Second screen	200 × 155 × 21 mm
Weight	
- Main unit	0.7 kg
- Second screen	0.4 kg
Power supply	Input: 100-240V 50/60Hz 0.3A Output: DC 9V 1A
Power consumption	9 W
Operating temperature range	0-45°C
Laser wavelength	650 nm
Video system	NTSC
Frequency response	20Hz-20KHz ± 1dB
Signal/noise ratio	≥ 80 dB
Audio distortion + noise	≤ -80 (1KHz)
Channel separation	≥ 80 dB
Dynamic range	≥ 80 dB
Audio out (analog audio)	Output level: 2V ± 10%
Load impedance	10 KΩ
Video out	Output level: 1V _{p-p} ± 20%
Load impedance	75 Ω

8 Troubleshooting



Warning

- Risk of electric shock. Never remove the casing of the player.

To keep the warranty valid, never try to repair the system yourself. If you encounter problems when using the player, check the following points before requesting service. If the problem remains unsolved, register your player and get support at www.philips.com/welcome.

No power

- Ensure that both plugs of the mains cord are properly connected.
- Ensure that there is power at the car cigarette lighter or AC outlet.

No sound

- Ensure that the AV cable is connected correctly.

Distorted picture

- Clean the disc. With a clean, soft, lint-free cloth, wipe the disc outwards from the center.
- Make sure that the video output format of the disc is compatible with the TV.
- Change the video output format to match your TV or program.
- The LCD is manufactured using high precision technology. You may, however, see tiny black points and/or bright points (red, blue, green) that continuously appear on the LCD. This is a normal result of the manufacturing process and does not indicate a malfunction.

Cannot play disc

- Ensure the disc label is upwards.
- Clean the disc. With a clean, soft, lint-free cloth, wipe the disc outwards from the center.
- Check if the disc is defective by trying another disc.

The player feels warm

- When the player is in use for a long period of time, its surface will be heated. This is normal.

Philips Consumer Lifestyle
A Division of Philips Electronics North America Corporation
P.O. BOX 671539, Marietta, GA. 30006-0026

Meet Philips at the Internet
<http://www.philips.com/welcome>

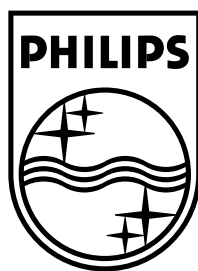

Printed in China

PET7402(S)_UM_V2.0