

Register your product and get support at
www.philips.com/welcome

GoGear



SA1MXX02B

SA1MXX02K

SA1MXX02KN

SA1MXX02W

SA1MXX04B

SA1MXX04K

SA1MXX04KN

SA1MXX04P

SA1MXX04W

SA1MXX04WS

SA1MXX08K

EN User manual

PHILIPS

Contents

1 Important safety information	4
General maintenance	4
Recycling the product	5
2 Your new Digital Audio Player	7
What's in the box	7
3 Getting started	8
Overview of the controls and connections	8
Overview of the main menu	8
Connect and charge	9
Connect the Digital Audio Player to a computer	9
Battery level indication	9
Disconnect the Digital Audio Player safely	9
Install software	10
4 Turn the GoGear Mix on and off	11
Automatic standby and shut-down	11
5 Music	12
Listen to music	12
Organize your music on the GoGear Mix	12
Find your music	12
6 Radio	13
Listen to FM radio	13
Manually tune a radio station	13
Auto-tune preset radio station	13
Play a preset radio station	13
7 Recordings	14
Record from FM radio (Available with some versions only!)	14
Record audio/voices	14
Listen to recordings	14
Upload your recordings to a computer	14
Delete recordings	15
Use the Digital Audio Player to carry data files	15
8 Settings	16
9 Update the Digital Audio Player	18
Manually verify / update firmware	18
10 Troubleshooting	19
11 Technical data	20
System requirements	20
Supported music file formats	20
12 Index	21
13 Glossary	22

Need help?

Please visit

www.philips.com/welcome

where you can access a full set of supporting materials such as the user manual, the latest software updates, and answers to frequently asked questions.

1 Important safety information

General maintenance

! Caution

- To avoid damage or malfunction:
- Do not expose the player to excessive heat caused by heating equipment or direct sunlight.
- Do not drop your player or allow objects to fall on your player.
- Do not allow your player to be submerged in water. Do not expose headphone socket or battery compartment to water, as water entering the set may cause major damage.
- Active mobile phones in the vicinity may cause interference.
- Back up your files. Ensure that you retain the original files you have downloaded to your device. Philips is not responsible for any loss of data if the product becomes damaged or not readable / legible.
- Manage (transfer, delete, etc.) your music files only with the supplied music software to avoid problems.
- Do not use any cleaning agents containing alcohol, ammonia, benzene, or abrasives as these may harm the set.
- Active mobile phones in the vicinity may cause interference.
- Back up your files. Please ensure that you retain the original files you have downloaded to your device. Philips is not responsible for any loss of data if the product becomes damaged or not readable / legible.
- Manage (transfer, delete, etc.) your music files only with the supplied or recommended software to avoid problems.

About operating and storage temperatures

- Operate in a place where temperature is always between 0 and 35°C (32 to 95°F)
- Store in a place where temperature is always between -20 and 45°C (-4 to 113°F).
- Battery life may be shortened in low temperature conditions.

Replacement parts/accessories:

Visit www.philips.com/support to order replacement parts/accessories.

Hearing Safety



Listen at a moderate volume:

Using headphones at a high volume can impair your hearing. This product can produce sounds in decibel ranges that may cause hearing loss for a normal person, even for exposure less than a minute. The higher decibel ranges are offered for those that may have already experienced some hearing loss.

Sound can be deceiving. Over time your hearing 'comfort level' adapts to higher volumes of sound. So after prolonged listening, what sounds 'normal' can actually be loud and harmful to your hearing. To guard against this, set your volume to a safe level before your hearing adapts and leave it there.

To establish a safe volume level:

Set your volume control at a low setting.

Slowly increase the sound until you can hear it comfortably and clearly, without distortion.

Listen for reasonable periods of time:

Prolonged exposure to sound, even at normally 'safe' levels, can also cause hearing loss.

Be sure to use your equipment reasonably and take appropriate breaks.

Be sure to observe the following guidelines when using your headphones.

Listen at reasonable volumes for reasonable periods of time.

Be careful not to adjust the volume as your hearing adapts.

Do not turn up the volume so high that you can't hear what's around you.

You should use caution or temporarily discontinue use in potentially hazardous situations.

Do not use headphones while operating a motorized vehicle, cycling, skateboarding, etc.; it may create a traffic hazard and is illegal in many areas.

Modifications

Modifications not authorized by the manufacturer may void user's authority to operate this device.

Copyright information

All other brands and product names are trademarks of their respective companies or organizations.

Unauthorized duplication of any recordings whether downloaded from the Internet or made from audio CDs is a violation of copyright laws and international treaties.

The making of unauthorized copies of copy-protected material, including computer programs, files, broadcasts and sound recordings, may be an infringement of copyrights and constitute a criminal offense. This equipment should not be used for such purposes.

The Windows Media and the Windows logo are registered trademarks of Microsoft Corporation in the United States and/or other countries.

Be responsible! Respect copyrights.



**Be responsible
Respect copyrights**

Philips respects the intellectual property of others, and we ask our users to do the same. Multimedia content on the internet may have been created and/or distributed without the original copyright owner's authorization. Copying or distributing unauthorized content may violate copyright laws in various countries including yours.

Compliance with copyright laws remains your responsibility.

The recording and transfer to the portable player of video streams downloaded to your computer is intended only for use with public domain or properly licensed content. You may only use such content for your private, non-commercial use and shall respect eventual copyright instructions provided by the copyright owner of the work. Such instruction may state that no further copies shall be made.

Video streams may include copy protection technology that prohibits further copying. For such situations the recording function will not work and you will be notified with a message.

Data logging

Philips is committed to improving the quality of your product and enhancing the Philips user experience. To understand the usage profile of this device, this device logs some info / data to the non-volatile memory region of the device. These data are used to identify and detect any failures or problems you as a user may experience while using the device. The data stored, for example, will be the duration of playback in music mode, duration of playback in tuner mode, how many times battery low was encountered, etc. The data stored do not reveal the content or media used on the device or the source of downloads. The data stored on the device are retrieved and used ONLY if the user returns the device to the Philips service center and ONLY to simplify error detection and prevention. The data stored shall be made available to user on user's first request.

Recycling the product

Your product is designed and manufactured with high quality materials and components, which can be recycled and reused. When you see the crossed-out wheel bin symbol attached to a product, it means the product is covered by the European Directive 2002/96/EC:



Never dispose of your product with other household waste. Please inform yourself about

the local rules on the separate collection of electrical and electronic products. The correct disposal of your old product helps prevent potentially negative consequences on the environment and human health.

Your product contains a built-in rechargeable battery covered by the European Directive 2006/66/EC, which cannot be disposed of with normal household waste. To safeguard the functionality and safety of your product, take your product to an official collection point or service centre where a professional can remove or replace the battery as shown:

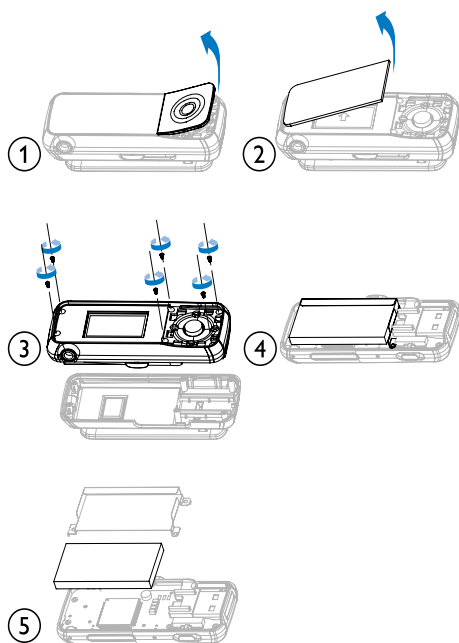

Please inform yourself about the local rules on separate collection of batteries. The correct disposal of batteries helps prevent potentially negative consequences on the environment and human health.

Notice for the USA

This equipment has been tested and found to comply with the limits for a Class B digital device, pursuant to part 15 of the FCC Rules. These limits are designed to provide reasonable

protection against harmful interference in a residential installation. This equipment generates, uses, and can radiate radio frequency energy and, if not installed and used in accordance with the instruction manual, may cause harmful interference to radio communications. However, there is no guarantee that interference will not occur in a particular installation. If this equipment does cause harmful interference to radio or television reception, which can be determined by turning the equipment off and on, the user is encouraged to try to correct the interference by one or more of the following measures:

- Relocate the receiving antenna.
- Increase the separation between equipment and receiver.
- Connect the equipment into an outlet on a circuit different from that to which the receiver is connected.
- Consult the dealer or an experienced radio/TV technician for help.

Notice for Canada

This Class B digital apparatus complies with Canadian ICES-003.

The set complies with the FCC-Rules, Part-15 and with 21 CFR 1040.10. Operation is subject to the following two conditions:

- This device may not cause harmful interference, and
- This device must accept any interference received, including interference that may cause undesired operation.

2 Your new Digital Audio Player

The GoGear Mix allows you to

- play MP3 and unprotected WMA files
- listen to FM radio
- make recordings

What's in the box

Check that you have received the following items:

Player



Earphones



Quick start guide



Note

- The images serve as reference only. Philips reserves the right to change color/design without notice.

3 Getting started

Overview of the controls and connections

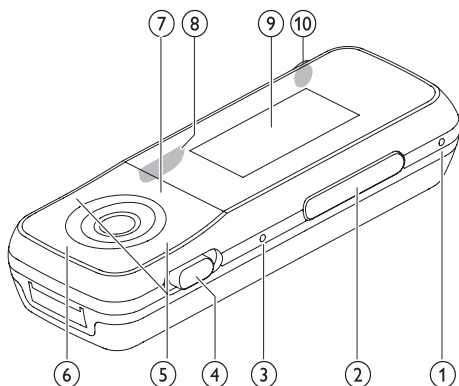

①	MIC	microphone
②	-VOL +	press: increase/decrease the volume press and hold: increase/decrease fast
③	RESET	press: reset the Digital Audio Player
④	🔒	slide: lock/unlock all buttons except -VOL +
	⏻	slide and hold: turn Digital Audio Player on/off
⑤	▲ / ▼	press: scroll up/down press and hold: scroll up/down at high speed
⑥	▶ 	press: play/pause
⑦	↶	press: back one level press and hold: return to root menu
⑧	🔌	slide out: extend USB connector plug
⑨		display
⑩	🎧	headphone jack

! Caution

- Listening to loud sounds for longer than a moment can be harmful to the listener.

You can set the volume level of the GoGear Mix to limit the maximum volume output.

- 1 From the main menu, select **[Settings]** > **[Sound Settings]** > **[Volume Limit]**.
- 2 Press the **- / +** volume controls to adjust the level.
- 3 Press **▶||** to confirm.
↳ When you set a volume limit, the GoGear Mix can no longer exceed the set volume, even if you press the volume **+** button.

To enable maximum volume again:

- 1 Select **[Settings]** > **[Sound Settings]** > **[Volume Limit]**.
- 2 Set the volume limit to maximum.
- 3 Press **▶||** to confirm.

Overview of the main menu

Menu	Mode	To
🎵	Music	play your digital audio tracks
📻	FM radio	listen to FM radio
📄	Recording	create or listen to recordings
📁	Folder view	view files in folders
⚙️	Settings	customize the settings of the Digital Audio Player
🎮	Now playing	show the current play screen

Connect and charge

The GoGear Mix has a built-in battery that can be charged through the USB port of a computer.

Connect the Digital Audio Player to a computer

- 1 Slide out the integrated USB plug (🔌) of the Digital Audio Player.
- 2 Connect the USB plug to a spare USB port on your computer.
- 3 Turn on your computer.
↳ The GoGear Mix charges.

Note

- For first-time use, allow the GoGear Mix to charge for 3 hours.
- The charging animation stops and the 🔌 icon is displayed when the charging process is completed.

When you connect the Digital Audio Player to the PC for the first time, a pop-up window appears:

- 1 Select **Install Philips Device Manager**.
- 2 Follow the on-screen instructions to complete the installation.

If the pop-up window is not displayed automatically:

- 1 Select **My Computer** (Windows XP / Windows 2000) / **Computer** (Windows Vista).
- 2 Right click on **Philips GoGear Mix**.
- 3 Select **Install Philips Device Manager**.
- 4 Follow the on-screen instructions to complete the installation.

Battery level indication

The display indicates the approximate levels of the battery status as follows:

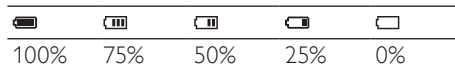

- ↳ A flashing battery screen indicates that the battery is low. The player saves all settings and switches off within 60 seconds.

Note

- Rechargeable batteries have a limited number of charge cycles. Battery life and number of charge cycles vary by use and settings.
- The charging animation stops and the 🔌 icon is displayed when the charging process is completed.

Tip

- You can conserve battery power and increase the play time of the Digital Audio Player if you go to 🔌 < **[Display Settings]** < **[Screen off timer]** and ensure that the shortest timer setting is selected.

Disconnect the Digital Audio Player safely

To avoid data loss, disconnect the Digital Audio Player from your computer as follows:

- 1 On your computer, exit all applications that are working with the Digital Audio Player.
- 2 Click 🖱️ in the task tray of your computer.
- 3 Wait for the confirmation that the GoGear Mix can be safely removed, then disconnect the Digital Audio Player from the USB port.

Install software

The Digital Audio Player contains the following software:

- **Philips Device Manager** (helps you get firmware updates for the Digital Audio Player)

The following files are loaded on the GoGear Mix:

- Quick Start Guide
- User Manual
- Frequently Asked Questions

4 Turn the GoGear Mix on and off

- 1 To toggle between modes on and off, slide and hold  for approximately 2 seconds.

Automatic standby and shut-down

The GoGear Mix has an automatic standby and shut-down feature that can save battery power. After 10 minutes in idle mode (no music plays, no button is pressed), the GoGear Mix switches off.



- 1 Slide and hold  for approximately 2 second to turn the GoGear Mix on again.

The Digital Audio Player has a lock switch to prevent accidental operation.

- 1 To lock the buttons when you play, move the slider to position .
 - ↳ All buttons except the volume keys are locked and the display shows a lock icon.
- 2 To unlock the buttons again, move the slider to the center position.

5 Music

Listen to music

- 1 From the main menu, select .
- 2 Navigate the sub-menus to select your music.
- 3 Press  to play.
 - Press  to toggle between pause and play.

Organize your music on the GoGear Mix

The GoGear Mix can store hundreds of music tracks. To organize and facilitate locating your music, the GoGear Mix allows you to sort your music into folders.

- 1 With the GoGear Mix connected to the USB port of the computer, open **Windows® Explorer**.
- 2 Create folders in the mass storage of the GoGear Mix.
- 3 Use drag and drop actions to sort your music into the folders.

Find your music

From the main menu, select  to enter music mode.

The Digital Audio Player offers the following menu options:

[All Songs]

- Alphabetically listed tracks

[Artists]

- Alphabetically listed artists
- Alphabetically listed albums
- Tracks listed in album order

[Albums]

- Alphanumerically listed albums
- Tracks listed in album order

[Playlists]

- **[Playlist-on-the-Go]**
- Tracks listed in playlist order



Note

- Alternatively, you can select  from the main menu and find your music files in folder view.





6 Radio

Listen to FM radio

- 1 From the main menu, select 
 - The earphones cable acts as FM antenna.



Manually tune a radio station

While in  mode, you can manually tune to a radio station:







- 1 To search for the next stronger signal, press and hold  / .
- 2 To fine tune the frequency, briefly press  / .

Auto-tune preset radio station

The auto-tune feature of the Digital Audio Player helps you find radio stations and save them under the preset numbers.

- 1 While in  mode, select **[Auto tune]**.
 - ↳ The radio automatically tunes radio stations and saves the frequencies to presets.
 - ↳ There are 20 presets available.
 - ↳ To stop auto tuning, press .
 - ↳ To exit radio, press and hold  for 2 seconds.

Play a preset radio station

- 1 While in  mode, select preset.
- 2 Press  or  to change to another preset.
- 3 To search for the next stronger signal, press and hold  or  for 2 seconds.
 - To exit radio, press and hold  for 2 seconds.







Note

- To play preset radio stations, you first have to store radio stations under presets. (see 'Auto-tune preset radio station' on page 13)

7 Recordings

Record from FM radio (Available with some versions only!)





- 1 From the main menu, select  > **[Start FM radio recording]**.
 - Press  to toggle between pause and record.
- 2 Press  to stop.
- 3 Press  to save the recording or press  to cancel.
 - ↳ Recordings are saved on the player. (Filename format: FMRECXXX.WAV, where XXX is the recording number that is generated automatically.)

Tip

- You can find your recordings under **[Recordings Library] > [FM Radio]**.

Record audio/voices

This is how you can record audio/voices with the built-in microphone (see section **Overview** for location of built-in microphone):

- 1 From the main menu, select  > **[Start voice recording]**.
 - Press  to toggle between pause and record.
- 2 Press  to stop.
- 3 Press  to save the recording or press  to cancel.
 - ↳ Recordings are saved on the player. (Filename format: VOICEXXX.WAV, where XXX is the recording number that is generated automatically.)



Tip

- You can find your recordings under **[Recordings Library] > [Voice]**.

Listen to recordings

- 1 From the main menu, select .



Listen to FM radio* recordings:

- 1 From the  menu select **[Recordings Library] > [FM Radio]**.
- 2 Select a recording.
- 3 Press  to play your recording.

Note

- * FM radio recording feature is available with some versions only. Refer to the on-screen menu of the Digital Audio Player to find out which features are available to you.

Listen to voice/audio recordings:

- 1 From the  menu select **[Recordings Library] > [Voice]**.
- 2 Select a recording.
- 3 Press  to play your recording.

Upload your recordings to a computer

- 1 Connect the Digital Audio Player to the computer (for instructions see section **Connect**).
- 2 On the computer, in **Windows® Explorer** select Digital Audio Player.
- 3 Select **Recordings > Voice** or **FM radio***.
- 4 Copy and paste the recordings to any location on the computer.



Note

- * FM radio recording feature is available with some versions only. Refer to the on-screen menu of the Digital Audio Player to find out which features are available to you.



Tip

- Use the computer to transfer your data files back to the computer, or delete your data files from the Digital Audio Player.

Delete recordings

Use a computer to delete recordings from the Digital Audio Player:

- 1 Connect the Digital Audio Player to the computer (for instructions see section **Connect**).
- 2 On the computer, in **Windows® Explorer** select Digital Audio Player.
- 3 Select **Recordings > Voice** or **FM radio***.
- 4 Select the recordings you want to delete.
- 5 On the computer, press **Delete**.
↳ The selected recordings are deleted.



Note

- * FM radio recording feature is available with some versions only. Refer to the on-screen menu of the Digital Audio Player to find out which features are available to you.

Use the Digital Audio Player to carry data files

You can use the Digital Audio Player to store and carry data files:

- 1 Connect the Digital Audio Player to the computer (for instructions see section **Connect and charge**).
- 2 On the computer, in **Windows® Explorer** copy the data files and paste them to the Digital Audio Player.

8 Settings

This is how you navigate and customize the

Settings:

- 1 Press ▲ / ▼ to select an option
- 2 Press ►|| to confirm a selection and go to the next level (when available).
- 3 Press ↶ to return to the previous level.
- 4 Press and hold ↶ to exit the **Settings** menu.

In the  menu, the following options are available:

Settings	Options menu	Sub-options menu
Play mode	Repeat	<ul style="list-style-type: none">• Repeat off (default)• Repeat 1• Repeat all
	Shuffle	<ul style="list-style-type: none">• Shuffle off (default)• Shuffle all
Sound settings	Equalizer	<ul style="list-style-type: none">• Off (default)• Funk• Hip hop• Jazz• Classical• Techno• Custom
	Volume limit	<ul style="list-style-type: none">• Off (default)• Set
Display settings	Theme	<ul style="list-style-type: none">• Black (default)• Pink• Blue
	Screen off timer	<ul style="list-style-type: none">• 40 sec. (default)• 50 sec.• 60 sec.• Always on
	Rotate screen	<ul style="list-style-type: none">• 0° (default)• 180°

Language	<ul style="list-style-type: none">• English (default)• Czech• Greek• German• Spanish• French• Italian• Hungarian	<ul style="list-style-type: none">• Dutch• Norwegian• Polish• Portuguese• Portuguese (Brazilian)• Russian• Slovak• Finnish	<ul style="list-style-type: none">• Swedish• Turkish• Simplified Chinese• Traditional Chinese• Japanese• Korean• Thai (<i>/97 version only</i>)
Information	Capacity Free space Firmware version Model Support site		
Factory settings	Restore factory settings (files are not affected.)	<ul style="list-style-type: none">• Yes• No	

9 Update the Digital Audio Player

The Digital Audio Player is controlled by an internal program called firmware. Newer versions of the firmware may have been released after you have purchased the Digital Audio Player:

The software program called **Philips Device Manager** can use your computer to check for firmware updates that are available on the Internet.

Install **Philips Device Manager** on your computer from the Digital Audio Player or download the latest version from www.philips.com/support.

Note

- Your music files are not affected by a firmware update.

- 5 When the display shows **Update completed**, click **OK**.
- 6 Disconnect the Digital Audio Player from the computer.
 - ↳ The Digital Audio Player restarts after the firmware is updated and is ready for use again.

Manually verify / update firmware

- 1 Ensure that your computer is connected to the Internet.
- 2 Connect the Digital Audio Player to the computer (see section **Connect and charge** for instructions).
- 3 On your computer, click **Start > Programs > Philips Digital Audio Player > GoGear Mix Device Manager** to launch **Philips Device Manager**.
- 4 Click **Update**
 - ↳ **Philips GoGear Mix Device Manager** checks for updates and installs new firmware from the Internet, if available.

10 Troubleshooting

If the GoGear Mix is not working properly or the display freezes, you can reset it without losing data:

How do I reset the GoGear Mix?

- Insert a pen tip or other object into the reset hole located at the bottom of the GoGear Mix. Hold until the player shuts down.
- If the reset option is unsuccessful, follow the steps how to recover the GoGear Mix with the **Philips Device Manager**:
 - 1 On your computer, select **Start > Programs > Philips Digital Audio Player > GoGear Mix Device Manager > Philips Device Manager** to launch the **Philips Device Manager**.
 - 2 Turn off the GoGear Mix before you continue.
 - 3 Press and hold the volume button **+** while you connect the GoGear Mix to your computer.
 - 4 Keep holding the key until the **Philips Device Manager** acknowledges the GoGear Mix and enters the recovery mode.
 - 5 On the computer, click the **Repair** button and follow the instructions of the **Philips Device Manager** to complete the recovery process.
 - 6 When the recovery is completed, disconnect the GoGear Mix from your computer.
 - 7 Restart the GoGear Mix.

11 Technical data

Power

Power supply: 250mAh Li-ion polymer internal rechargeable battery
Play time¹ (music): 25 hours

Software

Philips Device Manager: to restore and upgrade

Connectivity

Headphone 3.5 mm
USB 2.0 High speed

Sound

Channel separation: 45 dB
Frequency Response: 80 - 18 kHz
Output power: 2 x 3 mW
Signal to noise ratio: > 84 dB

Audio playback

Compression format:
MP3 bit rates: 8 - 320 kps and VBR
MP3 sample rates: 8, 11.025, 16, 22.050, 24, 32, 44.1, 48 kHz
WMA (unprotected) bit rates: 5 - 192 kbps VBR
WMA sample rates: 8, 11.025, 16, 22.050, 24, 32, 44.1, 48 kHz

Storage media

Built-in memory capacity²:
SA1MXX02K 2GB NAND Flash
SA1MXX04K 4GB NAND Flash
SAMXX04WS 4GB NAND Flash
SA1MXX08K 8GB NAND Flash

Music transfer³

Drag and drop in Windows® Explorer

Display

Color LCD 128 x 64 pixels

Note

- ¹ Rechargeable batteries have a limited number of charge cycles. Battery life and number of charge cycles vary by use and settings.
- ² 1GB = 1 billion bytes; available storage capacity is less. Full memory capacity may not be available as some memory is reserved for the player. Storage capacity is based on 4 minutes per song and 128 kbps MP3 encoding.
- ³ Transfer speed depends on operating system and software configuration.

System requirements

- Windows® XP / 2000 / Vista
- Pentium III 800 MHz processor or higher
- 128 MB RAM
- 500 MB hard disk space
- Internet connection
- Windows® Internet Explorer 6.0 or later
- USB port

Supported music file formats

The GoGear Mix supports the following music formats:

- MP3
- unprotected WMA

12 Index

B

Batteries , 9

D

Disposal 5

P

Protection , 11

V

Volume , 8

13 Glossary

D

Decibel (dB)

A unit of measure used to express relative difference in power or intensity of sound.

F

FM (Frequency Modulation)

In radio broadcasting: a method of modulation in which the frequency of the carrier voltage is varied with the frequency of the modulation voltage.

L

LCD (Liquid Crystal Display)

Probably the most common way to show visual information on non-computer electronic equipment.

M

MP3

A file format with a sound data compression system. MP3 is the abbreviation of Motion Picture Experts Group 1 (or MPEG-1) Audio Layer 3. With the MP3 format, one CD-R or CD-RW can contain about 10 times more data than a regular CD.

S

Shuffle

A feature that plays audio files (tracks) in random order.

V

Volume

Volume is the most common word used to specify the control of relative loudness of sounds. It also pertains to the function on many electronic devices that is used to control the loudness.

W

WMA (Windows Media Audio)

An audio format owned by Microsoft, is a part of Microsoft Windows Media technology. Includes Microsoft Digital Rights Management tools, Windows Media Video encoding technology, and Windows Media Audio encoding technology.

