

Register your product and get support at
www.philips.com/welcome

XL340



US Telephone

⚠ Warning
Use only rechargeable batteries.
Charge each handset for 24 hours before use.

PHILIPS

Table of contents

Important Safety Instructions	3	4 Getting started	10
1 Environment and safety	5	4.1 Connect the charger	10
1.1 Safety information	5	4.2 Insert the batteries in the handset	10
1.2 Power requirements	5	4.3 Charge batteries	10
1.3 Battery requirements	5	4.4 Standby mode	11
1.4 Telephone connection	5	4.5 Verify the signal	11
1.5 Environmental care	5	5 Using your phone	12
1.6 Precautions	5	5.1 Call	12
2 Important information	6	5.2 Answer a call	12
2.1 For your safety	6	5.3 Loudspeaker phone	12
2.2 Telephone connection	6	5.4 Adjust the audio volume	12
2.3 Need help?	6	5.5 End a call	12
2.4 Conformity	6	5.6 Make a second call	13
2.5 Safety precautions	6	5.7 Answer a second call	13
2.6 Digital security system	6	5.8 Conference call	13
3 Your phone	7	5.9 Use intercom	13
3.1 What's in the box	7	5.10 Text or number entry	13
3.2 Overview of the phone	8	6 Use more of your phone	15
3.3 Overview of the base	9	6.1 Phonebook memory	15
3.4 Display icons	9	6.2 Personalizing your phone	15

Table of contents

6.3	Advanced features	16	11.12	Radio Equipment	26
6.4	Use the headset	19	11.13	Do not attempt to repair or modify this equipment	26
7	Default settings	20	11.14	The RBRC® seal	26
8	Quick reference table for phone menus	21	12	Index	27
9	Technical data	22			
10	Frequently asked questions	23			
11	Appendix	24			
11.1	Equipment approval Information	24			
11.2	Notification to the local telephone company	24			
11.3	Notes	24			
11.4	Rights of the Phone Company	24			
11.5	Interference Information	24			
11.6	Noise	25			
11.7	FCC RF Radiation Exposure Statement	25			
11.8	Hearing Aid Compatibility (HAC)	25			
11.9	Privacy	25			
11.10	Additional Information	25			
11.11	Terminal Equipment	26			

Important Safety Instructions

Some of the following information may not apply to your particular product; however, when using telephone equipment, basic safety precautions should always be followed to reduce the risk of fire, electric shock and injury to persons, including the following:

1. Read and understand all instructions.
2. Follow all warnings and instructions marked on the product.
3. Unplug this product from the wall outlet before cleaning. Do not use liquid cleaners or aerosol cleaners. Use a damp cloth for cleaning.
4. Telephones should not be used while you are in a bathtub, shower or pool. Immersion of the telephone or handset in water could cause an electrical shock.
5. Slots and openings in the cabinet back or bottom are provided for ventilation, to protect it from overheating. These openings must not be blocked or covered. The openings should never be blocked by placing the product on the bed, sofa, rug, or other similar surface. This product should not be placed in a built-in installation unless proper ventilation is provided.
6. This product should be operated only from the type of power source indicated on the marking label. If you are not sure of the type of power supply to your home, consult your dealer or local power company.
7. Do not allow anything to rest on the power cord. Do not locate this product where the cord will be abused by persons walking on it.
8. Do not overload wall outlets and extension cords as this can result in the risk of fire or electric shock.
9. Never push objects of any kind into this product through cabinet slots as they may touch dangerous voltage points or short out parts that could result in a risk of fire or electric shock. Never spill liquid of any kind on the product.
10. To reduce the risk of electric shock, do not disassemble this product, but take it to a qualified service personnel when service or repair work is required. Opening or removing covers may expose you to dangerous voltages or other risks. Incorrect reassembly can cause electric shock when the appliance is subsequently used.
11. Do not expose the product to extreme temperatures such as areas near a hot radiator or stove or in a hot car.
12. Do not place lighted candles, cigarettes, cigars, etc., on the telephone.
13. Never touch uninsulated telephone wires or terminals unless the telephone line has been disconnected at the network interface.
14. Never install or modify telephone wiring during a lightning storm.
15. Never install telephone jacks in wet locations unless the jack is specifically designed for wet locations.
16. Use caution when installing or modifying telephone lines to prevent electrical shock and/or fire.
17. Unplug this product from the wall outlet and refer servicing to qualified service personnel under the following conditions:
 - A. When the power supply cord or plug is damaged or frayed.
 - B. If the product has been exposed to rain or water.
 - C. If the product does not operate normally by following the operating instructions.
 - D. If the product's cabinet has been damaged.
 - E. If the product exhibits a distinct change in performance.
18. Avoid using a telephone (other than a cordless type) during an electrical storm. There may be a remote risk of electric shock from lightning.
19. Do not use the telephone to report a gas leak in the vicinity of the leak.
20. Do not place this product on an unstable cart, stand or table. The product may fall, causing serious damage to the product.

IF YOUR PRODUCT UTILIZES BATTERIES, THE FOLLOWING ADDITIONAL PRECAUTIONS SHOULD BE OBSERVED:

1. Use only the type and size of battery(ies) specified in the user manual.
2. Do not dispose of the battery(ies) in fire. They may explode. Check with local codes for possible special disposal instructions.
3. Do not open or mutilate the battery(ies). Released electrolyte is corrosive and may cause damage to the eyes or skin. It may be toxic if swallowed.
4. Exercise care in handling battery(ies) in order not to short out the battery(ies) with conducting materials such as rings, bracelets, and keys. The battery(ies) or conductor may overheat and cause burns.
5. Do not attempt to recharge the battery(ies) provided with or identified for use with this product that are not intended to be charged. The battery(ies) may leak corrosive electrolyte or explode.
6. Do not attempt to rejuvenate the battery(ies) provided with or identified for use with this product by heating them. Sudden release of the battery(ies) electrolyte may occur causing burns or irritation to eyes or skin.
7. When replacing battery(ies), all batteries should be replaced at the same time. Mixing fresh and discharged batteries could increase internal cell pressure and rupture the discharged battery(ies). (Applies to products employing more than one separately replaceable primary battery.)
8. When inserting battery(ies) into this product, the proper polarity or direction must be observed. Reverse insertion of battery(ies) can cause charging, and that may result in leakage or explosion.
9. Remove battery(ies) from this product if storing over 30 days because the battery(ies) could leak and damage the product.
10. Discard "dead" battery(ies) as soon as possible since "dead" batteries are more likely to leak in a product.

11. Do not store this product, or the battery(ies) provided with or identified for use with this product, in high-temperature areas. Batteries that are stored in a freezer or refrigerator for the purpose of extending shelf life should be protected from condensation during storage and defrosting. Batteries should be stabilized at room temperature prior to use after cold storage.
12. If your product uses rechargeable battery(ies), charge the battery(ies) only in accordance with the instructions and limitation specified in the User Manual.

SAVE THESE INSTRUCTIONS

1 Environment and safety

1.1 Safety information

This telephone is not designed for making emergency telephone calls when the power fails. An alternative should be made available for access to emergency calling.

1.2 Power requirements

The product requires an electrical supply of 120 volts, single phase alternating current, excluding IT installations defined in standard UL 60950. In case of power failure, the communication can be lost.

1.3 Battery requirements

The handset requires power source of two rechargeable NiMH batteries, size AAA 1.2V 750mAh (HR11/45).

CAUTION

The electrical network is classified as dangerous according to criteria in the standard UL 60950. The only way to power down this product is by unplugging the power supply from the electrical outlet. Ensure the electrical outlet is located close to the apparatus and is always easily accessible.

1.4 Telephone connection

The voltage on the network is classified as TNV-3 (Telecommunication Network Voltages, as defined in the standard UL 60950). Following a power cut, the call in progress is lost.

Warning

Users should ensure for their own protection that the electrical ground connections of the power utility, telephone lines and internal metallic water pipe system, if present, are connected together. This precaution may be particularly important in rural areas.

1.5 Environmental care

Please remember to observe the local regulations regarding the disposal of your packaging materials, exhausted batteries and old phone and where possible promote their recycling.

1.6 Precautions

- Because the phone works by sending radio signals between the base unit and the handset, wearers of hearing aids may experience interference in the form of a humming noise.
- We advise that this phone should not be used near intensive care medical equipment, nor by persons with pacemakers.
- Your phone can interfere with electrical equipment such as answering machines, TV and radio sets, clock radios and computers if placed too close. It is recommended that you position the base unit at least one meter from such appliances.

CAUTION

Use only the mains adapter supplied with this telephone. Incorrect adapter polarity or voltage can seriously damage the unit.

Base adapter:

Input: 120 VAC 60 Hz

Output: 9 VDC 400 mA

Charger adapter:

Input: 120 VAC 60 Hz

Output: 9 VDC 200 mA

CAUTION

RISK OF EXPLOSION IF BATTERY IS REPLACED BY AN INCORRECT TYPE.

Never use nonrechargeable batteries; use recommended type supplied with this telephone. NiMH batteries must be disposed of in accordance with the applicable waste disposal regulations.

FCC CERTIFICATION NUMBER IS LOCATED ON THE CABINET BOTTOM

The term "IC:" before the certification number signifies that Industry Canada technical specifications were met. This certification means that the equipment meets certain radio communications and operational requirements.

2 Important information

2.1 For your safety

Before installing your XL340, carefully read the following information.

2.2 Telephone connection

Always use the line cable provided with the product otherwise you may not have a dialing tone.

2.3 Need help?

For more information on Troubleshooting and FAQ's:

- Online help: www.philips.com/support
 - Troubleshooting: see page 23
-

2.4 Conformity

Hereby, Philips declares that the XL340 is in compliance with the essential requirements and other relevant provisions of R&TE 1999/5/EC. This product can only be connected to the analogue telephone networks of the countries mentioned on the packaging. The Declaration of conformity is available on www.philips.com/support

2.5 Safety precautions

- Do not allow the handset to come into contact with water.
- Do not open the handset or the base station. You could be exposed to high voltages.
- Do not allow the charging contacts or the batteries to come into contact with conductive materials.
- Never use any battery type other than the one supplied : risk of explosion.

Warning

Metallic objects may be retained if placed near or on the handset receiver.

Disposal instructions for batteries:

Batteries should not be disposed of with general household waste.



Packaging information:

Philips has marked the packaging with standard symbols designed to promote the recycling and appropriate disposal of your eventual waste.

A financial contribution has been paid to the associated national recovery & recycling system.



The labeled packaging material is recyclable.



2.6 Digital security system

Your cordless phone uses a digital security system to protect against false ringing, unauthorized access, and charges to your phone line. There is a unique digital security code programmed in each unit. When the base and the handset is powered up the first time, the handset automatically registers with the base ready for normal use.

Note

If more than one handset is registered with the base, registration may take approximately one minute.

3 Your phone

Congratulations on your purchase and welcome to Philips!

To fully benefit from the support that Philips offers, register your product at www.philips.com/welcome.

3.1 What's in the box

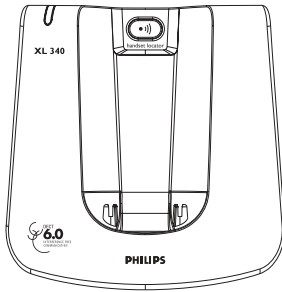

Base unit

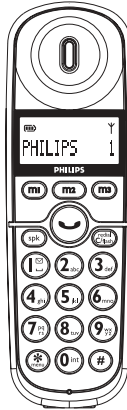

Handset

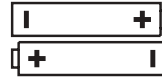

2 AAA rechargeable NiMH batteries

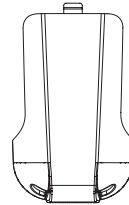

Battery door

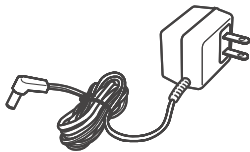

Power adaptor for base

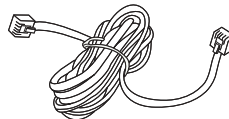

Line cord*

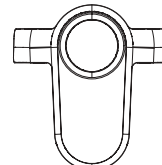

Belt clip



User manual



Quick start guide



Guarantee

Make sure you have all these items in the box. For missing item(s), contact your dealer.

In multi-handset packs, you will find additional handsets, chargers, power supplies, and batteries.

Note

*You may find in the box the line adaptor delivered separately from the line cord. In this case, please plug first this line adapter onto the line cord before connecting it to the line socket.

Note

This telephone system meets FCC standards for Hearing Aid Compatibility.

3.2 Overview of the phone

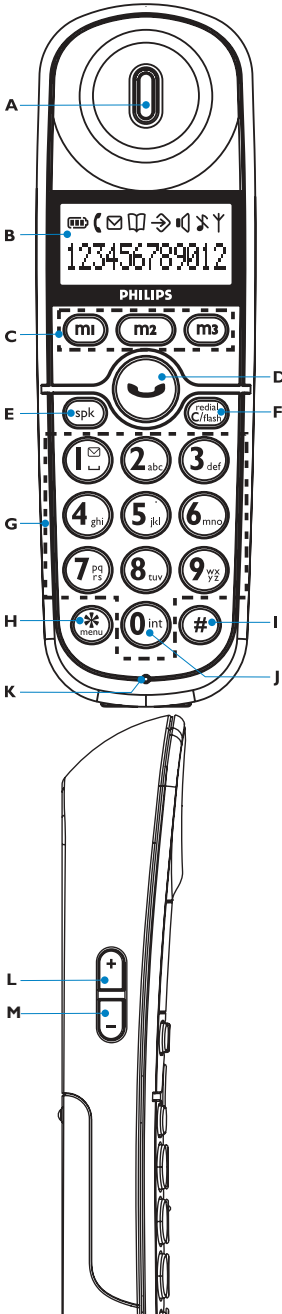

A Earpiece

B Display

C Direct memory keys

Use to access direct memories.

D Talk key

Use to take the line and answer a call.

In viewing memory, use to dial out the number.

Use to end a call.

E Speaker key

Use to turn on or off the speaker.

Use to change the ringing melody.

F Redial, Cancel & Recall key

Use to cancel an operation.

Use to redial the last dialed number.

Use to send out a flash.

G Digit keys

Use to dial digits and enter characters.

Use to access extra memories.

H Insert star & Program key

Use to insert * (star).

Use to enter program mode.

I Insert # & Pause key

Use to insert #.

Use to insert pause (P) when dialing.

J Intercom Key

Use to make intercom call.

K Microphone

L Volume up Key

Use to increase ringer and audio volume.

M Volume down Key

Use to decrease ringer and audio volume.

⚠ Warning

Handsfree activation could suddenly increase the volume in the loudspeaker to a very high level.

Make sure the handset is not too close to your ear.

3.3 Overview of the base

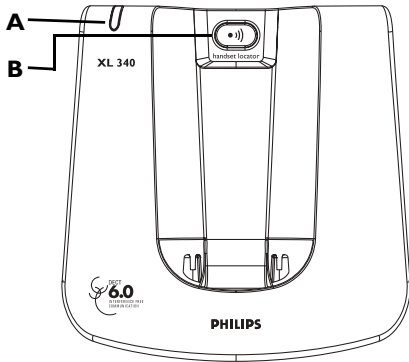

A LED

Steadily on when line is in use.
Blinking when receiving incoming call.
Blinking when having new message in mailbox.









B Page key

Use to locate handset(s).
Use to register handset(s).

3.4 Display icons

When being used for the first time, it is sometimes necessary to wait until the batteries are sufficiently charged before the icons appear on the display.

The display gives information about the operation of your telephone. The following icons can be shown in the headline of the display.

-  Displays the current battery level. It scrolls during charging.
-  The phone is in use. It blinks during ringing.
-  There is a new voice mail in your network mailbox (subscription needed).
-  Phonebook memory is being reviewed or edited.
-  The phone is in program mode.
-  Loudspeaker is turned on.
-  The ringer is turned off.
-  The handset is linked to the base.

4 Getting started

4.1 Connect the base

Place the base station close enough to the telephone and the mains power sockets so that the cables will reach.

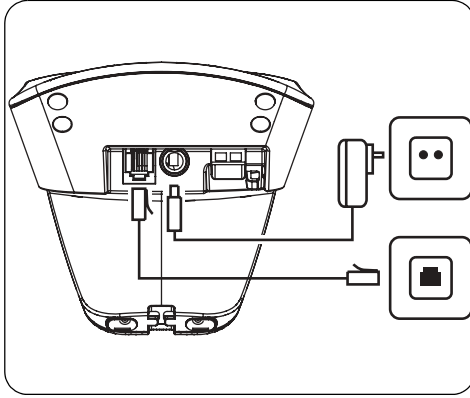

- 1 Connect the telephone line cord to the phone socket on the bottom of base unit and the wall phone sockets.

Note

To use this phone, you need an RJ11C (CA11A) type modular telephone jack, which might look like the one pictured here, installed in your home. If you do not have a modular jack, call your local phone company to find out how to get one installed.

- 2 Connect output plug of power adapter to the power socket on the bottom of base unit. Connect the power adapter to the wall mains supply.

Warning

The electrical network is classified as dangerous according to criteria in the standard EN 60950. The only way to power down this product is by unplugging the power supply from the electrical outlet. Ensure the electrical outlet is located close to the apparatus and is always easily accessible.

4.2 Connect the charger

If you have bought a multi-pack product, each extra handset comes with a charger and a charger adaptor.

- 1 Connect the output plug of the charger adaptor to the bottom of the charger.
- 2 Connect the charger adaptor to the wall mains supply.

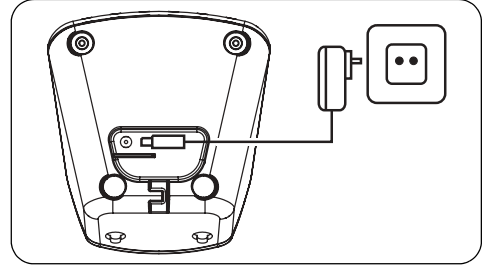

4.3 Insert the batteries in the handset

- 1 Place the two rechargeable batteries (included) into the battery compartment.

Warning

Verify the batteries polarity when inserting the batteries. Incorrect polarity may damage the product.

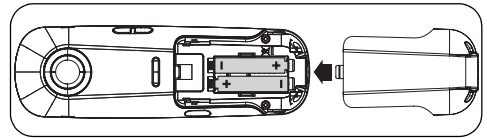

- 2 Slide the battery door firmly into place.

Warning

RISK OF EXPLOSION IF BATTERY IS REPLACED BY AN INCORRECT TYPE. USE RECOMMENDED TYPE SUPPLIED WITH THIS PRODUCT. NEVER USE NON-RECHARGEABLE BATTERIES.

4.4 Charge batteries

Warning

The base station must always be plugged into the mains when charging or when in use. Place handset on the base unit or the charger and let

the batteries continuously charge for 24 hours before using.

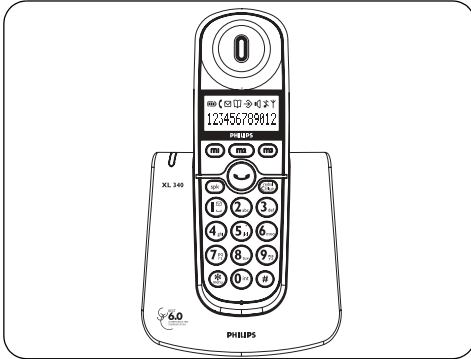

- The battery icon  appears on the screen when charging has started.

Note

If the batteries are completely exhausted, the product will not be able to power-on immediately. Handset may get warm during initial charge. This is normal.

Note

The warranty does not apply to the batteries and any other components which have a limited lifetime or are exposed to wear.

4.4.1 Low battery warning

An empty battery icon  indicates the batteries need recharging.

Place the handset on the base unit or the charger to recharge the batteries.

Note

Handset will go into sleep mode after reaching a very low battery voltage level.

Note

A low battery alert (during off hook) will also inform you that the handset has to be recharged. If it happens during a call, the call may end shortly after the alert.

4.4.2 Battery life and range

Optimal battery life is reached after 3 cycles of complete charging and discharging. Optimal range

is reached when there is no other electrical appliances working within the range area.

Battery life in talking mode:	Up to 12 hours
Battery life in standby mode:	Up to 150 hours
Indoor range:	Up to 50 meters
Outdoor range:	Up to 300 meters

4.5 Standby mode

Your phone is in standby mode when it is idle. The standby screen displays the handset name, handset number, battery icon, and the signal icon.

4.6 Verify the signal

The signal icon  displays the link status between your handset and the base unit.

 is steadily on: Your handset and base unit are linked.

 is flashing: Your handset and base unit have lost link.

5 Using your phone

5.1 Call

Warning

This telephone is not designed for making emergency telephone calls when the power fails. Alternative arrangements should be made for access to emergency services.

5.1.1 Make a call

- 1 Press  and wait for the dial tone.
 - 2 Dial the number you want to call.
 - *The number appears on display and is dialed.*
-

5.1.2 Call timer

The call timer shows the duration of your current call on display. It is shown in minutes and seconds (MM:SS) in the first hour. After that, it will be shown in hours and minutes (HH:MM).

5.1.3 Preparatory dialing (Pre-Dial)

With pre-dial, you can see and edit the number you are calling before dialing it.

- 1 Enter the number you want to call.
 - *The number appears on display.*



- 2 Press .

Note

You can enter up to 24 digits. Press  to delete an incorrect digit.

5.1.4 Redial the last number

With redialing, you can redial the last number dialed.

- 1 Press .
- 2 Press .

- *The last dialed number appears on display and is dialed.*
-

5.1.5 Call from phonebook memory

Press  while viewing a memory.

- *The phonebook memory appears on display and is dialed.*

Note

If the number is longer than 12 digits, only the last 12 digits are shown on display.

For more details on the phonebook memory function, see “Phonebook memory”, page 15.

5.2 Answer a call

When you receive a call, the phone will ring and  will flash on the display.

Press  to answer the call.

Note

If the ringer is turned off, the phone will not ring for the incoming call.

5.2.1 Answer a call in handsfree mode

The handsfree feature enables you to talk to the caller without holding onto the phone. It also allows others in the room to join in the conversation.

When you receive a call, the phone will ring and  will flash on the display.

Press  to answer the call.



5.3 Loudspeaker phone

During a call, press  to turn on and off the loudspeaker.

-  *appears on the handset display when loudspeaker is on.*
-

5.4 Adjust the audio volume



During a call,

- 1 press  to increase the audio volume,
 - 2 press  to decrease the audio volume.
-

5.5 End a call



Press  during a call to end it.

5.6 Make a second call

- 1 Press  during a call.
 - **R** appears and you will hear a dial tone.
- 2 Enter the number you want to call.
- 3 After the second call is answered, you can press  to toggle between these 2 calls.

5.7 Answer a second call

During a call, if another call comes in, the handset will sound a short beep periodically to notify you. You can answer it without ending the current call.

- 1 Press  when the second call comes in.
 - **R** appears on display, the current call will be put on hold, and you are talking with the second caller.
- 2 Press  subsequently to toggle between these 2 calls.

5.8 Conference call

5.8.1 Join a conversation

During a call, another handset can join the conversation by pressing .

- A short beep (alert tone) will apply to the original handset to notify the conference call is initiated.

Note

Only the handsets that are registered to the same base station can use this feature.



5.8.2 Exit from Conference call

During a conference call, press  to exit from the conference call.

- The other handset is still connected to the external caller.

5.9 Use intercom

You can call someone in the house by using the intercom function.



- 1 Press and hold .
- 2 If there are only 2 handsets registered to the base station, the intercom will be made automatically. Otherwise, enter the handset number you want to make the intercom call to.
- 3 Press  to answer the intercom when the phone is ringing.

Note







Only the handsets that are registered to the same base station can use this feature.

5.10 Text or number entry

You can enter texts and numbers for the phonebook memories and other features.

- 1 Press corresponding key as many times as necessary to reach the desired character.
- 2 Press  to delete a character. Press and hold  to delete all entered characters.
- 3 Press  to switch between uppercase and lowercase.
 - The characters entered thereafter will be in the alternate case.

Example to write "Peter"

- | | | |
|---|--|--------------|
| 1 | Press  once: | P |
| 2 | Press  once: | P |
| 3 | Press  twice: | Pe |
| 4 | Press  once: | Pet |
| 5 | Press  twice: | Pete |
| 6 | Press  three times: | Peter |



Upper case input table	
Keys	Assigned characters
1	[space] 1 , . ! ? : ; ' "
2	A B C 2 À Á Â Ã Ä Å Æ Ç
3	D E F 3 È É Ê Ë Ì
4	G H I 4 Ì Í Î Ï
5	J K L 5 []
6	M N O 6 Ñ Ò Ó Ô Õ Ö Ø Ù
7	P Q R S 7 Δ ⊙ Λ Ξ Σ
8	T U V 8 Ù Ú Û Ü
9	W X Y Z 9 Ý ÿ
0	0 \$ € @ _ () < > ~
*	* # + - / = & %

Lower case input table	
Keys	Assigned characters
1	[space] 1 , . ! ? : ; ' "
2	a b c 2 À Á Â Ã Ä Å Æ Ç
3	d e f 3 È É Ê Ë Ì
4	g h i 4 Ì Í Î Ï
5	j k l 5 []
6	m n o 6 Ñ Ò Ó Ô Õ Ö Ø Ù
7	p q r s 7 Δ ⊙ Λ Ξ Σ
8	t u v 8 Ù Ú Û Ü
9	w x y z 9 Ý ÿ
0	0 \$ € @ _ () < > ~
*	* # + - / = & %

6 Use more of your phone

6.1 Phonebook memory

Your phone has 12 phonebook memories providing you with the convenience for making calls. Each memory can store a name up to 12 characters and a number up to 24 digits.



Memory type	Associated key
Direct access memories	  
Extra memories	Digit keys 1 ~ 9

6.1.1 Save phonebook memory

In standby mode:

- 1 Enter the number.
Press and hold  to insert a pause.
 - It is shown as **P**.
- 2 Press and hold digit keys (1 to 9)

OR

- 2 Direct Memory (  ).
 - The number is saved. You will hear a confirmation tone and see **NAME?**.

- 3 Enter the name.
- 4 Press and hold the same memory key to save the name.

Note

Existing phonebook memory can be replaced by entering a number and a name at the same memory location. The new entry will overwrite the existing one without warning information shown.

6.1.2 View phonebook memory

You can view these memories when the handset is in standby mode.

Press Direct Memory   

OR

- press and hold digit keys (1 to 9).
- The name and number will be shown.

6.1.3 Delete all memories



You can delete all memories by using the **RESET** function. See page 17 for more information.

6.2 Personalizing your phone

6.2.1 Give your phone a name

You can give your phone a different name. If you have more than one handset, you can give each handset its own name. The handset name can be up to 10 characters long. It can be composed of A-Z, 0-9 and space.

In standby mode:

- 1 Press and hold  until you see **MENU?**.
- 2 Enter **40**.
- 3 Press and hold .
 - The current handset name is shown.
- 4 Edit the name.
- 5 Press and hold  to confirm.

6.2.2 Select display language

Your phone supports many languages.

In standby mode:

- 1 Press and hold  until you see **MENU?**.
- 2 Enter the language index number (see below).
- 3 Press and hold  to confirm.



Language Name	Index Number
English	10
Dutch	11
French	12
German	13
Italian	14
Russian	15
Spanish	16
Turkish	17
Danish	18
Swedish	19
Norwegian	20
Greek	21

Language Name	Index Number
Polish	22
Portuguese	23
Finnish	24
Hebrew	25

6.2.3 Turn the backlight on/off

The LCD and the key  can be lit when the phone is being used.



In standby mode:

- 1 Press and hold  until you see **MENU?**.
- 2 Enter **44**.
- 3 Press and hold  to confirm.
 - *The new setting is shown.*

6.2.4 Auto Pick-up

Auto Pick-up gives you the convenience of answering a call by picking up the handset from the cradle or charger. You don't need to press .



In standby mode:

- 1 Press and hold  until you see **MENU?**.
- 2 Enter **42**.
- 3 Press and hold  to confirm.
 - *The new setting is shown.*

6.2.5 Auto Hang-up

Auto Hang-up gives you the convenience of ending a call by putting the handset onto the charging cradle. You don't need to press .



In standby mode:

- 1 Press and hold  until you see **MENU?**.
- 2 Enter **43**.
- 3 Press and hold  to confirm.
 - *The new setting is shown.*

6.2.6 Auto Dialing



Auto Dialing gives you the convenience of making a call from phonebook memories associated to key 1 or 2 by pressing and holding the key 1 or 2 during standby. You don't need to press .

In standby mode:

- 1 Press and hold  until you see **MENU?**.
- 2 Enter **45**.
- 3 Press and hold  to confirm.
 - *The new setting is shown.*





6.2.7 Select ringing melody

In standby mode:

- 1 Press and hold  until you see the current melody name.
- 2 Select the desired melody by pressing digit keys 0 to 9.
- 3 Press  to confirm.

6.2.8 Change the ringing volume

In standby mode:

- 1 Press and hold  until you see the current melody name.
- 2 Press  and  to increase or decrease the volume level.
- 3 Press  to confirm.



Note

If ringing volume level is set to **OFF**,  appears.

6.2.9 Turn the key tone on/off

Key tones are tones your handset makes each time you press a key on the handset.

In standby mode:

- 1 Press and hold  until you see **MENU?**.
- 2 Enter **41**.
- 3 Press and hold  to confirm.
 - *The new setting is shown.*



6.3 Advanced features

6.3.1 Register a handset

If you have inadvertently unregistered your handset, you can register it again. Additional handsets must be registered to the base before use.

In standby mode:

- 1 Press and hold  until you see **MENU?**.

- 2 Enter **51**. Press and hold  until you see **BASE?**.
- 3 Select the base using the digit keys (1, 2, 3 or 4). Press and hold  until you see **SEARCHING...**
- 4 Press and hold  on the base unit for 3 seconds.
 - The base will turn on the LED for 30 seconds.
 - If registration is successful, handset will show **REGISTERED**.



 **Note**

If registration was not successful, the handset will show **FAILED**. Repeat the above procedures and try again.

6.3.2 Select a base

If your handset is registered to more than 1 base, you can select which base the handset will use. You can choose a fixed base or you can allow the handset to automatically search for a nearby available base (AUTO base selection).

In standby mode:



- 1 Press and hold  until you see **MENU?**.
- 2 Enter the base index number (see below).
- 3 Press and hold  to confirm.
 - If successful, handset will show the selected base. Otherwise, handset will show **FAILED**.

Base selection	Index Number
BASE 1	64
BASE 2	65
BASE 3	66
BASE 4	67
AUTO	68

6.3.3 Un-register a handset

A handset can un-register another handset registered to the same base station. It cannot un-register itself.

In standby mode:

- 1 Press and hold  until you see **MENU?**.
- 2 Enter **52**. Press and hold  until you see **HANDSET?**.

- 3 Enter the number of the handset you want to un-register. Press and hold  to confirm.
 - If un-registration is successful, your handset will show **DELETED**.

6.3.4 Reset your phone

You can reset your phone to factory settings. To find out what settings are being reset, see page 20.

In standby mode:

- 1 Press and hold  until you see **MENU?**.
- 2 Enter **01** if you want to delete all the memories during the reset.



OR

- 2 Enter **02** if you want to keep the memories unchanged during the reset.
- 3 Press and hold  until you see **PROCESSING...**

6.3.5 Select flash duration

This option is helpful when using operator services. The default value of flash duration that is preset in your XL340 should be the best suited for your country network and therefore you should not need to change it.

In standby mode:



- 1 Press and hold  until you see **MENU?**.
- 2 Enter the flash duration index number (see below).
- 3 Press and hold  until you see the new setting is displayed.

Flash duration	Index Number
FLASH 1	71
FLASH 2	72
FLASH 3	73
FLASH 4	74
FLASH 5	75
FLASH 6	76
FLASH 7	77

6.3.6 Select pause duration

This option is helpful when using operator services. The default value of pause duration that is preset in your XL340 should be the best suited for your country network and therefore you should not need to change it.

In standby mode:



- 1 Press and hold  until you see **MENU?**
- 2 Enter the pause duration index number (see below).
- 3 Press and hold  until you see the new setting is displayed.

Pause duration	Index Number
PAUSE 1	78
PAUSE 2	79

6.3.7 Select dial mode (country dependent)

The default value of dial mode that is preset in your XL340 should be the best suited for your country network and therefore you should not need to change it.

In standby mode:

- 1 Press and hold  until you see **MENU?**
- 2 Enter **60**.
- 3 Press and hold  to confirm.
 - *The new setting is shown.*

6.3.8 Temporary tone dialing in pulse dial mode

If the dialing mode is set to pulse, you can press and hold  to set temporary tone dialing.

- **d** will be displayed on the screen. All the following digits will be dialed as tones until you hang up.



6.3.9 Set prefix insertion

The prefix insertion feature checks and formats your outgoing call number before it is dialed. If the first few digits of the number match with the

digits you set as **DETECT**, they will be replaced by the digits you set as **PREFIX**.

For example, you set **DETECT** as **604** and **PREFIX** as **967**. When you are making a call to 6045551212, the actually dialed number will be 9675551212. The number shown is still 6045551212.

In standby mode:

- 1 Press and hold  until you see **MENU?**
 - 2 Enter **62**. Press and hold .
 - 3 Edit the **DETECT** digits
- OR**
- 3 enter a new one if you see **DETECT?** (such as 604 in the above example).

- 4 Press and hold  to confirm.
- 5 Edit the **PREFIX** digits

OR

- 5 enter a new one if you see **PREFIX?** (such as 967 in the above example).
- 6 Press and hold  to confirm.

 **Note**

If the dialed number starts with **#**, ***** or **P**, the **PREFIX** will not be added.

 **Note**

Press and hold  to insert a pause in **PREFIX**.

6.3.10 Message waiting indication

If you have subscribed to the voice mail service from your local service provider,  will be on when you have a new message in your mailbox. The LED on base station will blink.

After you've listened to all the new messages,  will turn off. The LED on base station will stop blinking.

 **Note**

You may also see **VOICEMAIL** shown on the display if you have new message in your mailbox, but it will disappear after you make an outgoing call.

6.3.11 Paging handset

You can use this feature to locate the handsets.

In standby mode, press  on the base.

- *All handsets registered to the base will produce the paging tone for 30 seconds and the screen displays **PAGING...***

Note

You can stop the paging by pressing any key on each handset or pressing  on the base again.

6.4 Use the headset

Headset is optional and not provided. A headset with 2.5mm jack and minimum 32 ohm speaker impedance must be used. It is available from retail store.

To use a headset, plug the headset into the headset jack at the side of the handset.

7 Default settings

These are the factory pre-programmed settings of your phone.

Functions	Settings after Reset
Display Language	English
Handset Name	PHILIPS
Auto Pick-up	Off
Auto Hang-up	On
Backlight	On
Dial Mode*	Tone
Key Tone	On
Flash Duration*	Flash 2
Pause Duration	Pause 1
Prefix	[Empty]
Melody Selection	RING 1
Ring Volume	3 blocks
Receiver Volume	3 blocks
Speaker volume	3 blocks
Message Waiting Indication	Off
Base selection	AUTO
Auto Dialing	Off
Last dialed number	[Empty]
Phonebook memories**	[Empty]

* Country dependent features

**These memories will remain unchanged for Reset 02, refer to section 6.3.4

8 Quick reference table for phone menus

The table below lists the menus of your phone.

Reminder: Press and hold ***#** until you see **MENU?** to enter the menu index number.

Press **END** to exit from any menu instantly.

Index Number	Menu
01	Full Reset
02	Partial Reset
10 - 25	Language
40	Handset Name
41	Key Tone
42	Auto Pick-up
43	Auto Hang-up
44	Backlight
45	Auto Dialing
51	Registration
52	Un-registration
60	Dial Mode
62	Prefix Insertion
64 - 68	Base Selection
71 - 77	Flash Duration
78 - 79	Pause Duration

9 Technical data

General telephone features

- Caller name & number identification
- 12 phonebook memories with direct access
- Conference call and voicemails
- Intercom
- Base selection

Battery

- 2 x AAA NiMH 750mAh batteries

Weight and dimensions

- Handset: 160 grams
180 x 32 x 56 mm (H x D x W)
- Base: 150 grams
94 x 128 x 117 mm (H x D x W)

Temperature range

- Operation: 0°C to +46°C
- Storage: -25°C to +70°C

Relative humidity

- Operation: Up to 95% at 40°C
- Storage: Up to 95% at 40°C

10 Frequently asked questions

www.philips.com/support

In this chapter you will find the most frequently asked questions and answers about your phone.

Set up

No dial tone

- Check the phone and power connections.
- The handset may be out of range. Move closer to the base station.
- The battery capacity may be low. Charge battery.

“Range/Signal” icon is flashing

- Move closer to the base station.
- If the handset displays **UNREGISTERED**, register the handset, see page 16.

The handset does not switch on

- Charge the battery: Put the handset on base/charger. The battery icon is animated while charging. After a few moments the phone will switch on.

The handset does not charge

- Check base/charger connections.
- The battery may be defective. Purchase new battery from your dealer.
- Check that the batteries are inserted correctly.
- Make sure the handset is placed properly on the base/charger. The battery icon is animating while charging.

Communication is lost during a call

- Charge the battery.
 - Move closer to the base station.
-

Sound

Handset does not ring

- Check that the handset melody volume is

turned on. See page 16.

- Too many phones may be sharing the same phone line. Disconnect some of the phones.

No parking tone from the handset

- Check the power connections of the base/charger.
 - The handset may not be placed properly. Try again.
 - Charging contacts may be dirty. Clean contacts with a damp cloth.
-

Product behaviour

Bad audio quality (crackles, echo, etc.) during a call

- The handset may be nearly out of range. Move closer to the base station.
- The phone may be interfered by nearby electrical appliance. Move the base unit to a different location.
- The phone may be at a location with thick walls. Move the base unit to a different location.

Caller ID does not display

- Caller ID service may not be activated. Check with your service provider.
- The caller's information may be withheld or is unavailable.
- Let the phone ring at least once before answering it.

Second call service does not work

- Second call service may not be activated. The second call service may not be available from your telephone operator, check availability of the service with your telephone service provider.
- Check that the flash selection is correct. See page 17.

* Tip

If the above solutions do not help, remove the power from both the base station and the handset. Wait for 15 minutes and try again.

11.1 Equipment approval Information

Your telephone equipment is approved for connection to the public switched telephone network and is in compliance with parts 15 and 68, FCC Rules and Regulations and the Technical Requirements for Telephone Terminal Equipment published by ACTA.

11.2 Notification to the local telephone company

On the bottom of this equipment is a label indicating, among other information, the US number and Ringer Equivalence Number (REN) for the equipment. You must, upon request, provide this information to your telephone company.

The REN is useful in determining the number of devices you may connect to your telephone line and still have all of these devices ring when your telephone number is called. In most (but not all) areas, the sum of the RENs of all devices connected to one line should not exceed 5. To be certain of the number of devices you may connect to your line as determined by the REN, you should contact your local telephone company.

A plug and jack used to connect this equipment to the premises wiring and telephone network must comply with the applicable FCC Part 68 rules and requirements adopted by the ACTA. A compliant telephone cord and modular plug is provided with this product. It is designed to be connected to a compatible modular jack that is also compliant. See installation instructions for details.

11.3 Notes

- This equipment may not be used on coin service provided by the telephone company.
- Party lines are subject to state tariffs, and therefore, you may not be able to use your

- own telephone equipment if you are on a party line. Check with your local telephone company.
- Notice must be given to the telephone company upon permanent disconnection of your telephone from your line.
- If your home has specially wired alarm equipment connected to the telephone line, ensure the installation of this product does not disable your alarm equipment. If you have questions about what will disable alarm equipment, consult your telephone company or a qualified installer.

11.4 Rights of the Phone Company

Should your equipment cause trouble on your line which may harm the telephone network, the telephone company shall, where practicable, notify you that temporary discontinuance of service may be required. Where prior notice is not practicable and the circumstances warrant such action, the telephone company may temporarily discontinue service immediately. In case of such temporary discontinuance, the telephone company must:

(1) promptly notify you of such temporary discontinuance; (2) afford you the opportunity to correct the situation; and (3) inform you of your right to bring a complaint to the Commission pursuant to procedures set forth in Subpart E of Part 68, FCC Rules and Regulations.

The telephone company may make changes in its communications facilities, equipment, operations or procedures where such action is required in the operation of its business and not inconsistent with FCC rules and Regulations. If these changes are expected to affect the use or performance of your telephone equipment, the telephone company must give you adequate notice, in writing, to allow you to maintain uninterrupted service.

11.5 Interference Information

This device complies with Part 15 of the FCC Rules. Operation is subject to the following two conditions:

(1) this device may not cause harmful interference; and (2) this device must accept any interference received, including interference that may cause undesired operation.

This equipment has been tested and found to comply with the limits for a Class B digital device, pursuant to Part 15 of the FCC Rules. These limits are designed to provide reasonable protection against harmful interference in a residential installation.

This equipment generates, uses, and can radiate radio frequency energy and, if not installed and used in accordance with the instructions, may cause harmful interference to radio communications. However, there is no guarantee that interference will not occur in a particular installation.

If this equipment does cause harmful interference to radio or television reception, which can be determined by turning the equipment off and on, the user is encouraged to try to correct the interference by one or more of the following measures:

- Reorient or relocate the receiving antenna (that is, the antenna for radio or television that is “receiving” the interference).
- Reorient or relocate and increase the separation between the telecommunications equipment and receiving antenna.
- Connect the telecommunications equipment into an outlet on a circuit different from that to which the receiving antenna is connected.

If these measures do not eliminate the interference, please consult your dealer or an experienced radio/television technician for additional suggestions. Also, the Federal Communications Commission has prepared a helpful booklet, “How To Identify and Resolve Radio/TV Interference Problems”. This booklet is available from the U.S. Government Printing Office, Washington, D.C. 20402.

Please specify stock number 004-000-00345-4 when ordering copies.

11.6 Noise

Electrical pulse noise is present at one time or another. This is most intense during electrical storms. Certain kinds of electrical equipment, such as light dimmers, fluorescent bulbs, motors, fans, etc., also generate pulse noise. Because radio frequencies are susceptible to this, you may on occasion hear pulse noise through the receiver. This is usually only a minor annoyance and should not be interpreted as a defect of the unit.

11.7 FCC RF Radiation Exposure Statement

This equipment complies with FCC RF radiation exposure limits set forth for an uncontrolled environment. This equipment should be installed and operated with a minimum distance of 20 centimeters between the radiator and your body. This transmitter must not be co-located or operating in conjunction with any other antenna or transmitter.

For hand held operation, this phone has been tested and meets the FCC RF exposure guidelines. For Body-worn operation, use only with the belt clip. Use of other accessories may not ensure compliance with FCC RF exposure guidelines.

11.8 Hearing Aid Compatibility (HAC)

This telephone system meets FCC and Industry Canada standards for Hearing Aid Compatibility.

11.9 Privacy

Privacy of communications may not be ensured when using this telephone.

11.10 Additional Information

I.C. Notice

11.11 Terminal Equipment

⊖ Note

This equipment meets the applicable Industry Canada Terminal Equipment Technical Specifications.

This is confirmed by the registration number. The abbreviation, IC, before the registration number signifies that registration was performed based on a Declaration of Conformity indicating that Industry Canada technical specifications were met. It does not imply that Industry Canada approved the equipment.

⊖ Note

The Ringer Equivalence Number (REN) for this terminal equipment is marked on the equipment itself. The REN assigned to each terminal equipment provides an indication of the maximum number of terminals allowed to be connected to a telephone interface. The termination on an interface may consist of any combination of devices subject only to the requirement that the sum of the Ringer Equivalence Numbers of all the devices does not exceed five.

11.12 Radio Equipment

The term "IC:" before the radio certification number only signifies that Industry Canada technical specifications RSS-213 and ICES-003 were met. Operation is subject to the following two conditions : (1) this device may not cause interference, and (2) this device must accept any interference, including interference that may cause undesired operation of the device.

11.13 Do not attempt to repair or modify this equipment

Repairs to certified equipment should be made by an authorized maintenance facility designated by the supplier.

Any repairs or alterations made by the user to the equipment may render the equipment void in

product warranty and compliance. This could also void the user's authority to operate the equipment.

USA/CANADA Service Center

PHILIPS

1881 Route 46 West
Ledgewood, NJ 07852

Phone: 1-800-233-8413 (English/Français)

E-mail: accessorysupport@philips.com

11.14 The RBRC® seal



The RBRC® Seal on the nickel metal hydride battery indicates that Philips Royal Electronics is voluntarily participating in an industry program to collect and recycle these batteries at the end

of their useful lives, when taken out of service within the United States and Canada.

The RBRC® program provides a convenient alternative to placing used nickel metal hydride batteries into the trash or municipal waste, which may be illegal in your area.

Philips's participation in RBRC® makes it easy for you to drop off the spent battery at local retailers participating in the RBRC® program or at authorized Philips product service centers. Please call 1-800-8-BATTERY for information on Ni-MH battery recycling and disposal bans/restrictions in your area. Philips's involvement in this program is part of its commitment to protecting our environment and conserving natural resources.

RBRC® is a registered trademark of Rechargeable Battery Recycling Corporation.

12 Index

A

Additional Information 25
Advanced features 16
Answer a call 12
Answer a second call 13
Appendix 24
Audio volume, adjust 12
Auto Dialing 16
Auto Hang-up 16
Auto Pick-up 16

B

Backlight on/off 16
Base, overview 9
Batteries 10
Battery 22
Battery door 10
Battery life and range 11
Battery requirements 5

C

Call 12
Call from phonebook memory 12
Call timer 12
Caller ID 23
Character set table 14
Charge batteries 10
Charger 10
Conference call 13
Conformity 6
Connect the base 10
Connect the charger 10
Connection 5, 6

D

Default settings 20
Delete all phonebook memories 15
Dial mode, change 18
Digital security system 6
Dimensions 22
Display 8
Display icons 9
Display language, select 15

Do not attempt to repair or modify this
equipment 26

E

Earpiece 8
End a call 12
Environmental care 5
Equipment approval Information 24
Example text entry 13
Exit from Conference call 13

F

FCC RF Radiation Exposure Statement 25
Flash duration, select 17
Frequently asked questions 23

G

Getting started 10

H

Handsfree mode 12
Hearing Aid Compatibility (HAC) 25
Help 6

I

Important Safety Instructions 3
Insert the batteries 10
Intercom 13
Interference Information 24

K

Key tone on/off 16
Keys, phone 8

L

LED, base 9
Line adaptor 7
Line cord, connect 10
Loudspeaker phone 12
Low battery warning 11
Lower case input table 14

M

Make a call 12
Message waiting indication 18
Multi-handset packs 7

N

Name, handset 15
Noise 25
Notes 24
Notification to the local telephone company 24
Number entry 13

P

Page key 9
Paging handset 19
Pause duration, select 18
Personalizing 15
Phone, overview 8
Phonebook memory 15
Power adapter, connect 10
Power requirements 5
Precautions 5
Pre-Dial 12
Prefix set 18
Privacy 25

Q

Quick reference table for phone menus 21

R

Radio Equipment 26
Range 11
Redial last number 12
Register a handset 16
Relative humidity 22
Reset phone 17
Rights of the Phone Company 24
Ringer OFF 16
Ringing melody, select 16
Ringing volume, change 16

S

Safety 5, 6
Save phonebook memory 15
Second call 13
Select a base 17
Service Center 26
Signal icon 11
Standby mode 11

T

Technical data 22
Temperature range 22
Temporary tone dialing 18
Terminal Equipment 26
Text or number entry 13
The RBRC[®] seal 26
Troubleshooting 23

U

Un-register a handset 17
Upper case input table 14

V

View phonebook memory 15
Voicemail 18

W

Warranty 11
Weight 22
What's in the box 7



© 2007 Koninklijke Philips Electronics N.V.
All rights reserved.

Reproduction in whole or in part is prohibited without
the written consent of the copyright owner.

Document order number: 3111 285 33712



Printed in PRC