

**PHILIPS**

AC4924, AC4926  
AC3824, AC3822



---

ZH-S 简体中文

1

---

EN User manual

29



# 目录

<b>1 重要事项</b>	<b>4</b>	<b>6 更换滤网和滤芯</b>	<b>22</b>
安全	4	了解健康空气智能锁	22
		更换纳米级劲护滤网	22
		更换纳米云旋转式加湿滤网	23
		更换抗菌滤芯	24
<b>2 空气净化器</b>	<b>6</b>	<b>7 故障排除</b>	<b>25</b>
产品概述	7		
控件概述	8	<b>8 保修与服务</b>	<b>27</b>
		订购部件或附件	27
<b>3 使用入门</b>	<b>9</b>	<b>9 声明</b>	<b>27</b>
安装纳米级劲护滤网	9	电磁场 (EMF)	27
加湿准备	10	回收	27
<b>4 使用产品</b>	<b>12</b>		
了解空气质量指示灯	12		
打开和关闭	12		
设置湿度级别	12		
切换操作模式	13		
使用灯光开/关功能	13		
切换显示模式	13		
更改自动模式设置	14		
更改风扇速度	15		
设置定时器	15		
设置童锁	16		
水位	16		
<b>5 清洁</b>	<b>17</b>		
清洁计划	17		
清洁产品机身	17		
清洁空气质量传感器	17		
清洁水箱、蓄水盘和纳米云旋 转式加湿滤网	18		
清洁预过滤网	19		
为纳米云旋转式加湿滤网除垢	20		

# 1 重要事项

## 安全

使用本产品之前，请仔细阅读本用户手册，并妥善保管以备日后参考。

## 危险

- 切勿让水或任何其它液体或易燃性清洁剂进入产品，以免发生触电和/或火灾。
- 切勿用水或任何其它液体或（易燃性）清洁剂来清洁产品，以免发生触电和/或火灾。
- 切勿在产品周围喷洒杀虫剂或香水等任何可燃材料。
- 水箱中的水不适合饮用。请勿饮用这些水，也不要用它们喂养动物或浇花。清空水箱时，请将水倒入水槽。

## 警告

- 在将产品接通电源以前，首先确认产品侧面所标示的电压是否与当地的电压相符。
- 如果电源软线损坏，为避免危险，必须由制造厂或其维修部或类似的专职人员来更换。
- 如果插头、电源线或产品本身受损，请勿再使用本产品。

- 本产品不可由肢体残障，精神障碍或缺乏相关经验和技能的人（包括8岁以上儿童）使用，除非有负责安全的人员对他们进行产品使用的相关指导或说明，方可使用本产品。
- 不要让儿童在无人监督的情况下进行清洁和保养。
- 应照看好儿童，确保他们不玩耍本器具。
- 请勿堵塞进风和出风口，例如不要将物体放置在出风口上或进风口前方。

## 注意

- 本产品不能替代正常通风、日常吸尘或者在烹饪时使用的抽油烟机。
- 如果连接产品的电源插座接触不良，则产品的插头可能会变得很热。确保所连接的电源插座接触良好。
- 一定要在干燥、稳固、平整且水平的表面上放置和使用本产品。
- 产品的后侧及两侧均要留出至少 20 厘米的空间，产品上方至少要留出 30 厘米的空间。
- 切勿在产品顶部放置任何物品。

- 切勿将产品直接放在空调下方，以防冷凝水滴到产品中。
- 打开产品电源之前，务必确保已经正确安装所有过滤网。
- 只能使用飞利浦专门为本产品设计的原装过滤网。切勿使用任何其它过滤网。
- 请勿用硬物敲击本产品（尤其是进风口和出风口）。
- 请勿将手指或物体插入出风口或进风口，以防止产品出现物理损坏或发生故障。
- 当您使用室内喷雾式驱虫剂或在充满油污、易燃气体或化学烟雾的地方时，请勿使用本产品。
- 请勿在气体用具、加热装置或火炉附近使用本产品。
- 使用之后以及注水、清洁产品或执行其他维护之前，务必拔掉电源插头。
- 请勿在温度变化较大的房间内使用本产品。
- 为防止产生干扰，产品与使用无线电波的电器（例如电视机、收音机和无线电控制时钟）之间至少应保持 2 米距离。
- 当产品长期不用时，过滤网上可能会生长细菌。长时间不用之后，请仔细检查过滤网。如果过滤网非常脏，请进行更换（请参阅“更换滤网和滤芯”一章）。
- 本产品仅限于家用并在正常运行条件下使用。
- 请勿在潮湿环境或高温环境中（例如浴室、卫生间或厨房）使用本产品。
- 本产品不能去除一氧化碳 (CO) 或氡 (Rn)，因此在发生燃烧和危险化学品事故时，不能作为安全设备使用。
- 只能向水箱中注入冷水。切勿使用地下水或热水。
- 切勿将水以外的任何物质放入水箱。切勿将香水倒入水箱中。
- 如果您长时间不使用加湿功能，请清洁水箱和纳米云旋转式加湿滤网托盘，并将纳米云旋转式加湿滤网晾干。
- 如果需要移动产品，请先断开产品的电源。然后倒空或移除水箱和蓄水盘。握住产品两侧的手柄水平移动产品。
- 注水和清洁时，请拔下设备的电源插头。

## 2 空气净化器

感谢您的惠顾，欢迎光临飞利浦！  
为充分享受飞利浦提供的支持，请在  
[www.philips.com/welcome](http://www.philips.com/welcome) 注册您的  
产品。

飞利浦空气净化器可为您的房间带来清新湿润空气，保证家人的健康。本产品具有采用了 NanoCloud 技术的高级蒸发系统，使用特殊加湿滤网向干燥的空气中添加水分子，并产生健康的湿润空气，而不会形成水雾。其加湿滤网可以吸附水中的细菌、水垢和其他微粒。它只向您家中提供纯净的湿润空气。冬季或使用空调时不再有干燥的空气。使用本产品之前，请仔细阅读本用户手册，并妥善保管以备日后参考。

## 产品概述

A 控制面板

B 水箱

C 抗菌滤芯

D 加湿滤网支座

E 蓄水盘

F 万向轮  
(仅适用于AC4924和AC4926)

G 加湿滤网轮盘

对于AC4924/AC4926:  
纳米云旋转式加湿滤网  
(FY4445)

H 对于AC3822 /AC3824:  
纳米云旋转式加湿滤网  
(FY3435)

I 背盖

J 预过滤网

对于AC4924/AC4926:  
纳米级劲护滤网 专业S3型  
(FY3137)

K 对于AC3822 /AC3824:  
纳米级劲护滤网 专业S2型  
(FY2428)

L 出风口

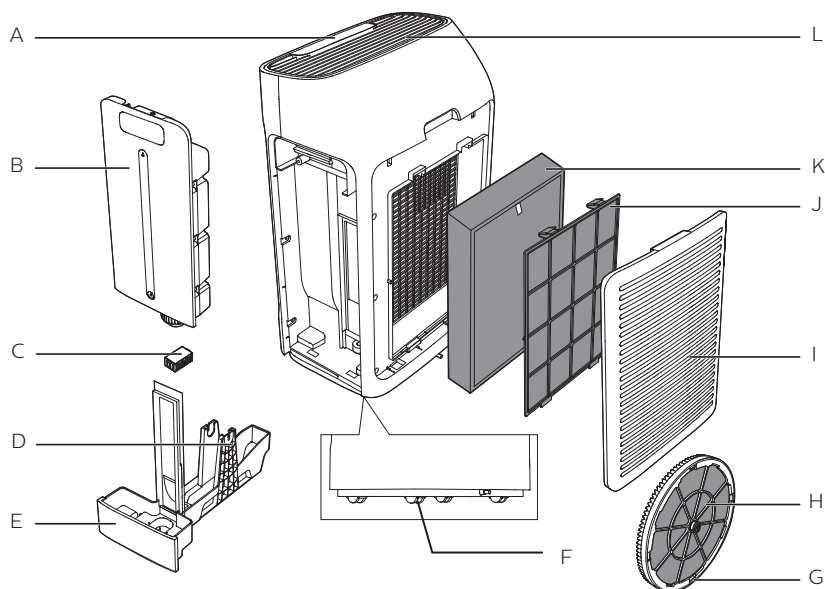



## 控件概述

### 控制按钮

 开/关按钮

 童锁按钮

 智能模式按钮

 风扇速度按钮

 湿度级别按钮

 光线调节按钮

 二合一模式开关按钮

 定时器/重置按钮

### 控制按钮



### 显示面板:

 睡眠模式

 自动模式

 去过敏原模式

 纯净化模式

 二合一模式

 过滤网更换提醒

 注水提示

 预过滤网和加湿滤网清洁提醒

PM2.5 PM2.5 显示

IAI 室内过敏原指数

## 显示面板

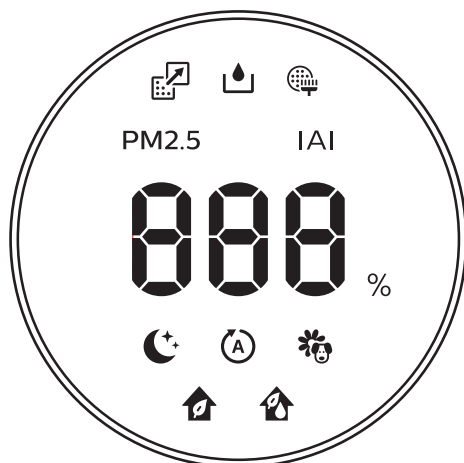



## 3 使用入门

### 安装纳米级劲护滤网

使用产品之前，请先除去滤网的包装。然后按如下所述将其放到产品中：

#### 注意

- 确保带拉片的一面朝向您。

- 1 将后面板顶部拉向自己，将其从产品上取下。

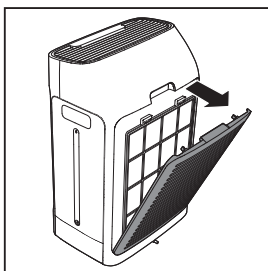

- 2 向下按两个固定夹，然后朝您自己的方向拉动预过滤网。

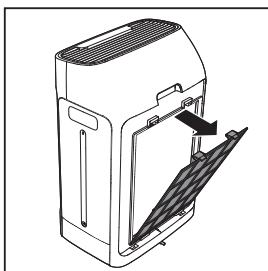

- 3 去除纳米级劲护滤网的所有包装材料。

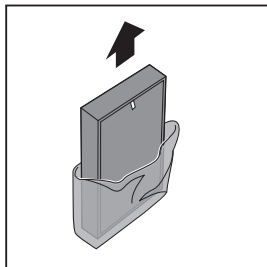

- 4 将纳米级劲护滤网放回产品中。

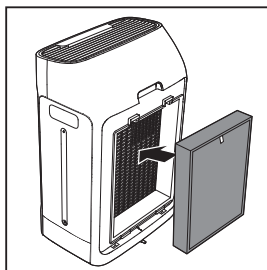

- 5 将预过滤网放回产品内部，请先将预过滤网安装到产品底部，然后朝产品方向推动预过滤网顶部的固定夹。

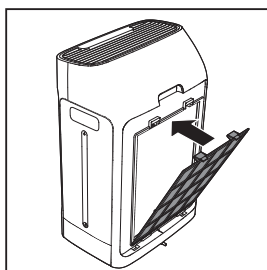

- 6 要重新安装后盖，请先将面板安装到产品底部，然后朝产品方向推动面板顶部。

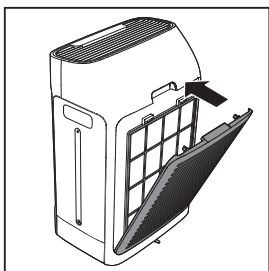

- 3 去除纳米云旋转式加湿滤网的所有包装材料。

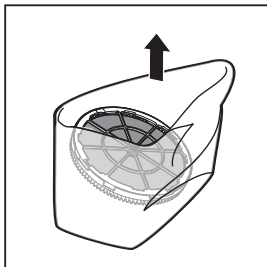

## 加湿准备

- 1 拉出水箱。

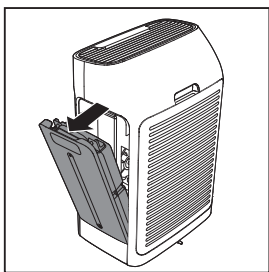

- 2 向上轻轻提起水盘，再水平拉出。

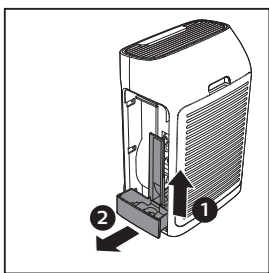

### 注意

- 加湿滤网在您购买产品时已经组装在加湿滤网轮盘上。

- 4 将加湿滤网轮置于滤网支座上。

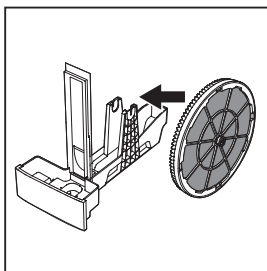

### 注意

- 将加湿滤网轮盘放在加湿滤网支座上时，请确保加湿滤网轮盘上的凸起部位卡入相应的凹槽。

5 将蓄水盘放回产品中。

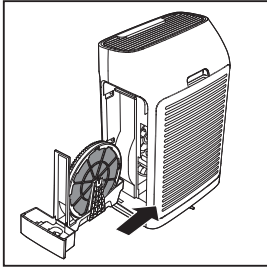

6 逆时针旋开水箱顶盖。

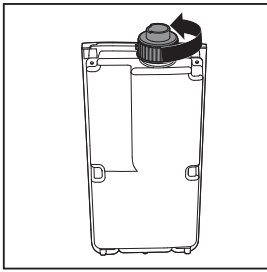

7 向水箱中注入冷水。

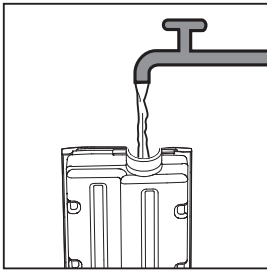

8 顺时针旋转顶盖将其牢牢锁定到水箱上。

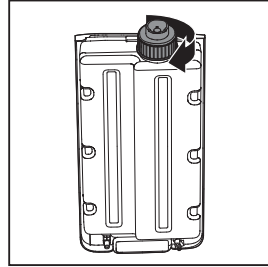

9 将水箱放回产品中。

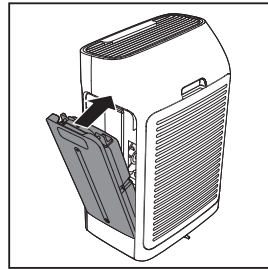



## 4 使用产品

### 了解空气质量指示灯

PM2.5 水平	空气质量指示灯颜色	空气质量级别
≤35	蓝色	良好
36-75	蓝紫色	一般
76-115	紫红色	较差
>115	红色	非常差

产品打开后，空气质量指示灯会自动亮起，并按顺序亮起所有颜色。片刻后，空气质量传感器会选择与环境空气质量相对应的颜色。

### 打开和关闭

- 1 将电源插头接入插座。
  - ↳ 产品发出蜂鸣音。
- 2 轻触  可启动产品。
  - ↳ 默认情况下，产品将在二合一模式下运行，屏幕上会显示 .
  - ↳ 产品预热时，屏幕上会显示“---”。默认情况下，在测量空气中的可吸入颗粒物后，产品将显示 PM2.5 水平并在自动模式下运行。
  - ↳ 测量空气质量约 30 秒后，空气质量传感器会自动选择相应的空气质量指示灯颜色。
- 3 长按  3 秒可关闭产品。

#### 注意

- 通过开/关按钮 ，关闭产品后，如果插头仍在插座中，再次打开产品时，产品将根据上次的设置工作。

### 设置湿度级别

- 1 反复轻触湿度按钮 ，可将所需空气湿度设置为 40%、50%、60% 或 “- -”。

#### 注意

- 选择湿度级别“- -”后，产品将一直为房间加湿，直至环境湿度达到 70%RH。

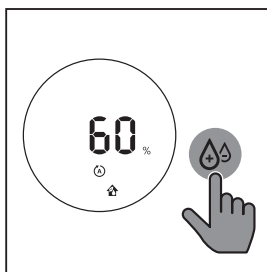

#### 注意



- 达到目标湿度级别时，加湿轮盘将停止旋转。当湿度低于目标空气湿度时，加湿滤网将再次开始旋转。
- 如果您想快速提高加湿级别，则可以选择更高的风扇速度。

## 切换操作模式

产品具有两种操作模式，即空气净化器模式和二合一模式。

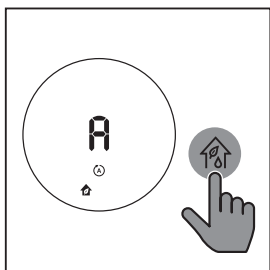

- 反复轻触模式选择按钮  可在空气净化器模式和二合一模式之间切换。



- ↳ 当产品在空气净化器模式下运行时，屏幕上会显示 。
- ↳ 当产品在二合一模式下运行时，屏幕上会显示 。

## 使用灯光开/关功能

使用光线调节按钮可打开或关闭空气质量指示灯、显示屏和功能指示灯（如果需要）。

- 1 轻触一次光线调节按钮 ，空气质量指示灯将变暗。
- 2 再次轻触光线调节按钮 ，空气质量指示灯和显示面板将熄灭。
- 3 第三次轻触光线调节按钮 ，所有指示灯均将重新亮起。

## 切换显示模式

产品具有三种显示模式，即 PM2.5 显示、IAI 显示和湿度显示。

### PM2.5

即使是空气中最细微的颗粒变化，AeraSense 传感技术也可精确地检测并快速响应。它提供实时的 PM2.5 反馈，让您安枕无忧。

### IAI

专业级 AeraSense 传感器可检测室内空气过敏原的级别，然后用 1 至 12 之间的数字进行级别反馈，显示室内空气过敏原的潜在风险级别。1 表示空气质量最佳。

### 注意

- 默认情况下，产品在 PM2.5 显示模式下运行。

- 1 按住  3 秒可切换至 IAI 显示。

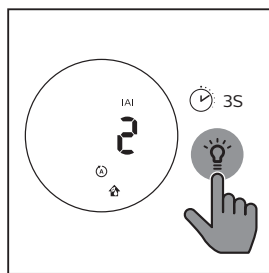

- ↳ 屏幕上会显示 IAI 指示灯和实际的 IAI 级别。

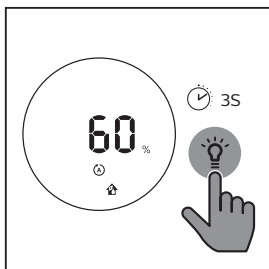

- 2 再次按住  3 秒可切换至实际的湿度显示。

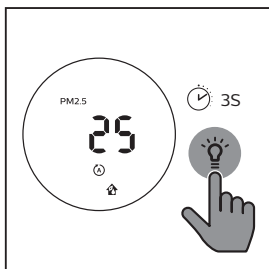

- 3 按住  3 秒可切换至 PM2.5 显示。  
↳ 屏幕上会显示 PM2.5 指示灯和实际的 PM2.5 水平。





## 更改自动模式设置

可选择自动模式 ()、去过敏原模式 () 和睡眠模式 (SL)。

### 智能模式

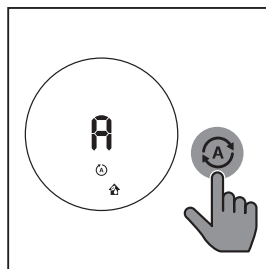

在自动模式下，产品会根据环境空气湿度和空气质量选择风扇速度。

- 轻触自动模式按钮 () 可选择自动模式。
  - ↳ 屏幕上会显示自动 () 和 ()。
  - ↳ 默认情况下，产品会在自动模式下运行。



### 去过敏原模式

超敏感的去过敏原模式经过精心设计，旨在对周围空气中的微小过敏原等级变化作出反应。

- 轻触自动模式按钮 () 可选择去过敏原模式。
  - ↳ 屏幕上会显示自动 () 和 ()。

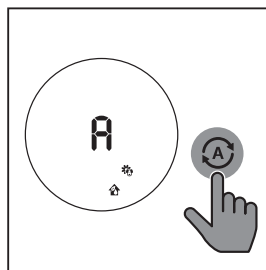

## 睡眠 (SL)

在睡眠模式下，空气净化器将以非常低的速度安静地运行。

- 反复轻触自动模式按钮 (A) 可选择睡眠模式 (SL)。  
↳ 屏幕上会显示睡眠 (SL) 和 。

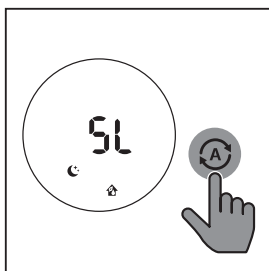

- 一分钟以后，如果没有按钮被按下，除了 ，所有指示灯均会熄灭。
- 按任意按钮可打开指示灯。

## 更改风扇速度

本产品提供了多种风速设置。

### 手动

- 反复轻触风速按钮 (F) 可选择所需的风速 (1、2 或 3)。

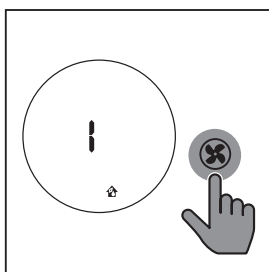

## 劲速 (t)

在劲速模式下，空气净化器会以最高速度运行。

- 轻触风速按钮 (F) 可选择劲速模式 (t)。

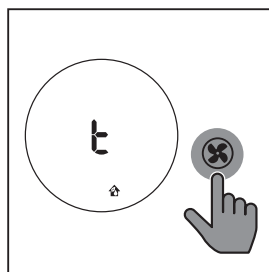

## 设置定时器

使用定时器，可设定产品运行的小时数。到达设定的时间时，产品将自动关闭。

- 反复轻触定时器/重置按钮 (T) 可选择您想要产品运行的小时数。  
↳ 定时器的设置范围为 1 至 12 小时。

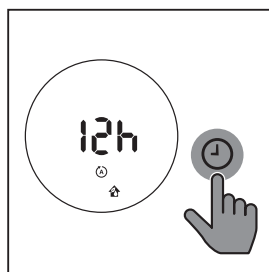

- 要停用定时器功能，请反复轻触定时器/重置按钮 (T)，直至屏幕上显示“---”。

## 设置童锁

- 1 按住童锁按钮  3 秒可激活童锁。  
↳ **L** 将在屏幕上显示 3 秒钟。  
↳ 打开童锁时, 其他所有按钮均将没有反应。

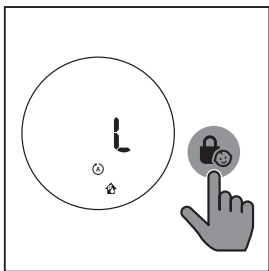

- 2 按住童锁按钮  3 秒可停用童锁。  
↳ **UL** 将在屏幕上显示 3 秒钟。

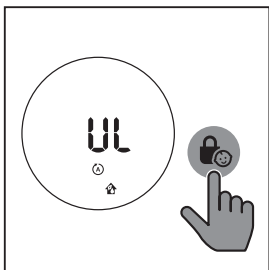

## 水位

可通过水箱上的水位窗看见水箱中的水位。

水箱中的水量不足时, 注水指示灯  将开始闪烁, 指示为水箱加水。

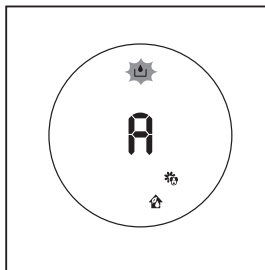

### 注意

- 水箱中缺水时, 滤网轮将停止旋转。水箱重新注水后, 滤网轮盘将再次开始旋转。



## 5 清洁

### 注意

- 清洁前务必拔掉电源插头。
- 切勿将本产品浸入水中或任何其它液体中。
- 切勿使用研磨性、腐蚀性或易燃性清洁剂（例如漂白剂或酒精）清洁本产品的任何部件。
- 只有预过滤网和纳米云旋转式加湿滤网可以水洗。纳米级劲护滤网不可水洗，也不可真空吸尘器清洁。

### 清洁计划

频率	清洁方法
必要时	使用干软布清洁产品表面。
每周	冲洗水箱、蓄水盘和纳米云旋转式加湿滤网。
当清洁图标  亮起时，屏幕上会显示 FO	清洁预过滤网。
	用稀释的白醋（醋酸度为 5%）或稀释的柠檬酸为纳米云旋转式加湿滤网除垢。

### 清洁产品机身

定期清洁产品的内侧和外侧，防止灰尘积聚。

- 1 使用柔软的干布擦去产品机身上的灰尘。
- 2 用柔软的干布擦拭出风口。

### 清洁空气质量传感器

每 2 个月清洁一次空气质量传感器，确保净化器处于最佳功能状态。如果净化器用在多尘的环境中，请经常进行清洁。

### 注意

- 当室内的湿度非常高时，空气质量感应器上可能会形成冷凝水。因此，即使空气质量良好，空气质量指示灯也可能指示空气质量差。在这种情况下，您必须清洁空气质量感应器或者使用任一手动速度设置。

- 1 使用软毛刷清洁空气质量传感器进风口和出风口。

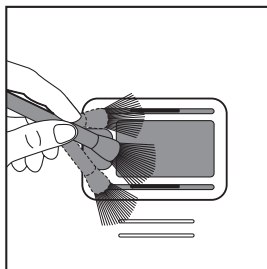

- 2 打开空气质量传感器保护盖。

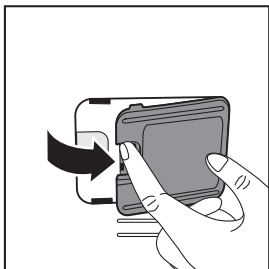

- 3 使用稍微浸湿的棉签，清洁空气质量感应器、进风口和出风口。

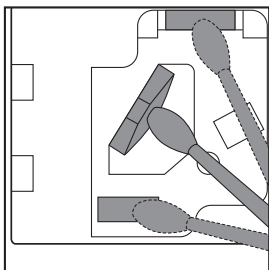

- 4 使用干棉签将其擦干。

- 5 重新盖上空气质量感应器的保护盖。

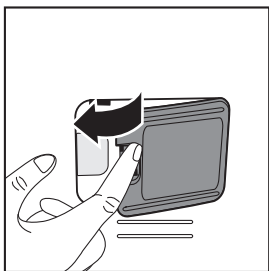

## 清洁水箱、蓄水盘和纳米云旋转式加湿滤网

### 注意

- 每周清洁水箱、蓄水盘和纳米云旋转式加湿滤网，使其保持清洁卫生。

- 1 拉出水箱。

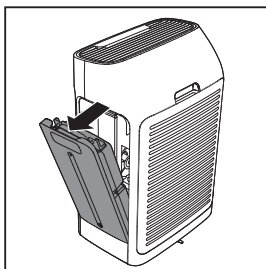

- 2 向上轻轻提起水盘，再水平拉出。

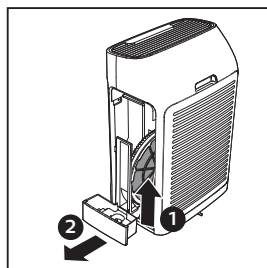

- 3 将加湿滤网轮盘从滤网支座上取下。

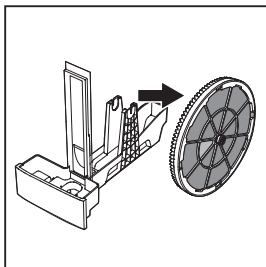

- 4 用自来水冲洗水箱、蓄水盘和 纳米云旋转式加湿滤网。

### 注意

- 清洁过程中，请勿将纳米云旋转式加湿滤网从轮上取下。
- 不要擦洗纳米云旋转式加湿滤网或将其置于阳光直射的地方。
- 如有必要，请使用温和的清洁剂清洁水箱和蓄水盘。在这种情况下，彻底冲洗水箱和蓄水盘。

- 5 将水箱外侧和蓄水盘擦干。
- 6 将加湿滤网轮盘置于滤网支座上。

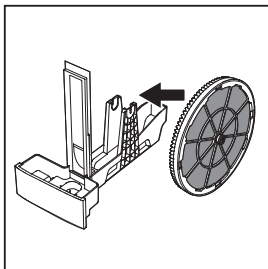

### 注意

- 将加湿滤网轮盘放在机芯支座上时，请确保加湿滤网轮盘上的凸起部位卡入相应的凹槽。

- 7 将水盘放回产品中。

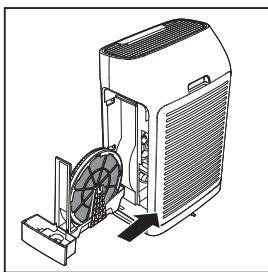

- 8 将水箱放回产品中。

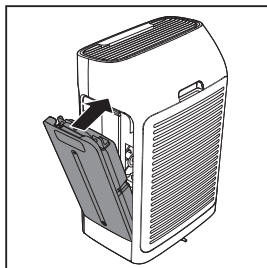

## 清洁预过滤网

### 注意

- 如果预过滤网已损毁、磨损或损坏，请勿使用。访问 [www.philips.com/support](http://www.philips.com/support) 或与您所在国家/地区的客户服务中心联系购买。

滤网提示灯状态	按此操作
当屏幕上显示 FO， 预过滤网和加湿滤网 清洁提示灯  亮起	清洁预过滤网

- 1 将后面板顶部拉向自己，将其从产品上释放。

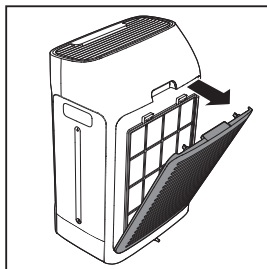

- 2 要卸下预过滤网，请向下按两个固定夹，然后朝您自己的方向拉动过滤网。

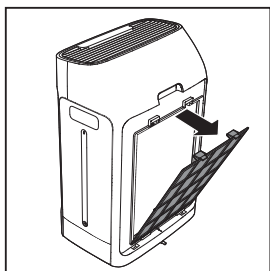

- 3 在水龙头下冲洗预过滤网。如果很脏，请使用软刷清除上面的灰尘。

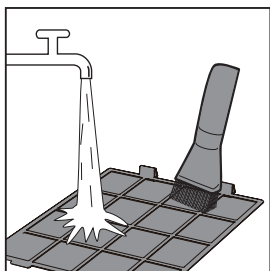

- 4 晾干预过滤网。

### 注意

- 确保预过滤网完全干燥。如果仍然是湿的，细菌可能会乘虚而入，因此缩短预过滤网的使用寿命。

- 5 预过滤网完全干燥后，将其放回后面板中。

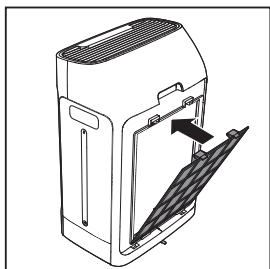

- 6 轻触并按住 3 秒可重置预过滤网清洁时间。

## 为纳米云旋转式加湿滤网除垢

滤网提示灯状态	按此操作
当屏幕上显示 FO，预过滤网和加湿滤网清洁提示灯  亮起	为纳米云旋转式加湿滤网除垢

- 1 拉出水箱。

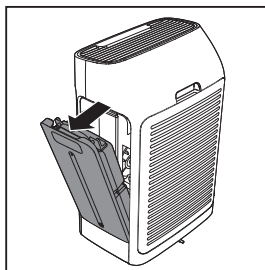

- 2 向上轻轻提起水盘，再水平拉出。

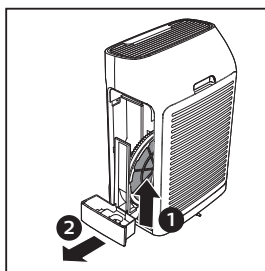

- 3 将加湿滤网轮盘从滤网支座上取下。

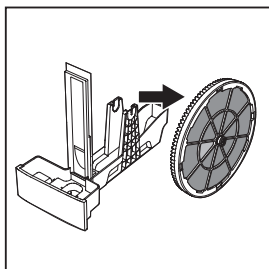

- 4 将纳米云旋转式加湿滤网在清洁剂（例如，稀释的白醋、柠檬酸溶液）中浸泡 2 小时。

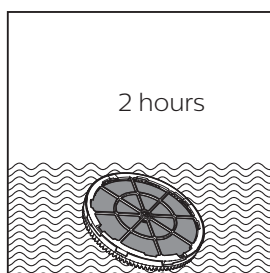

### 注意

- 请使用中性或酸性清洁剂
- 将白醋（醋酸度为 5%）与等量的水混合
- 4 升水 + 24 克柠檬酸
- 如果过滤网上面有白色残留物（水垢），请确保将带有白色残留物的一面浸入水中。
- 除垢过程中，请勿将纳米云旋转式加湿滤网从轮上取下。

- 5 在水龙头下冲洗纳米云旋转式加湿滤网，以冲洗掉残留的醋或者柠檬酸。冲洗过程中，翻转滤网，将正面和背面都冲洗干净。

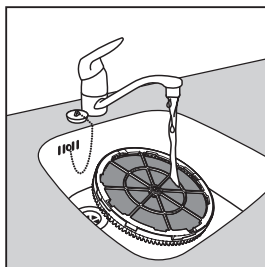

- 6 将纳米云旋转式加湿滤网晾干。

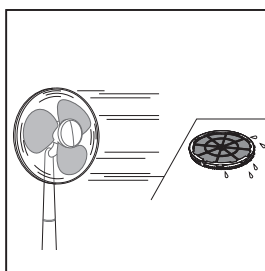

### 注意

- 请勿将纳米云旋转式加湿滤网置于阳光直射的地方。
- 7 轻触并按住  3 秒可重置纳米云旋转式加湿滤网的清洁时间。

## 6 更换滤网和滤芯

### 了解健康空气智能锁

本产品配备健康空气智能锁，旨在确保产品运行过程中，纳米级劲护滤网和加湿滤网在最佳条件下工作。当纳米级劲护滤网和加湿滤网快要失效时，更换指示灯  会开始闪烁，指示需要更换滤网。

如未及时更换净化滤网和加湿滤网，则产品将停止运行并被锁定。

### 更换纳米级劲护滤网

#### 注意

- 纳米级劲护滤网不可水洗，也不可重复使用。
- 在更换过滤网之前，务必先关闭空气净化器并从电源插座上拔下插头。

滤网提示灯状态	按此操作
屏幕上显示 A3 且滤网更换指示灯  会闪烁。	更换纳米级劲护滤网专业S3型 (AC4924/AC4926)，纳米级劲护滤网专业S2型 (AC3822/AC3824)

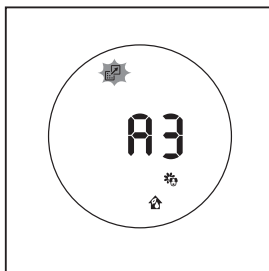

- 1 将用过的纳米级劲护滤网从产品上取下。

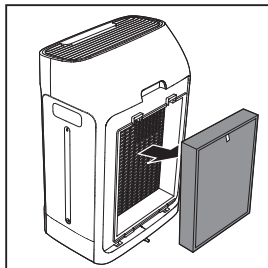

#### 注意

- 请勿接触滤网的褶皱面，或闻滤网的气味，因为其包含从空气中收集的污染物。
- 弃置用过的滤网后，请洗净双手。

- 2 去除新的纳米级劲护滤网的所有包装材料。

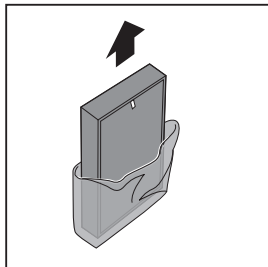

- 3 将新的纳米级劲护滤网放入产品中。

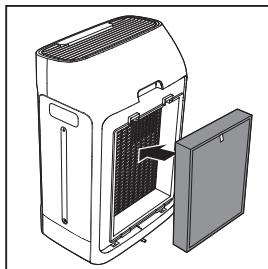

- 4 轻触并按住  3 秒可重置纳米级劲护滤网使用寿命计数器。

## 更换纳米云旋转式加湿滤网

滤网提示灯状态	按此操作
屏幕上显示 F1 且滤网更换指示灯  会闪烁。	更换纳米云旋转式加湿滤网

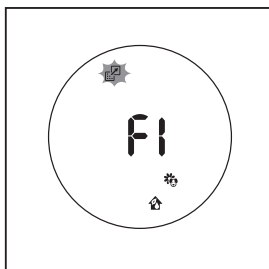

- 1 将加湿滤网轮盘从滤网支座上取下。

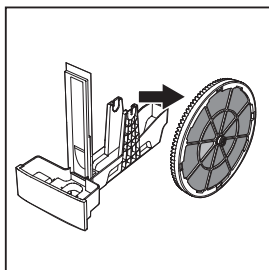

- 2 握住轮盘另一侧的转轴旋钮，逆时针旋转，将转轴从加湿滤网轮盘上拆下。

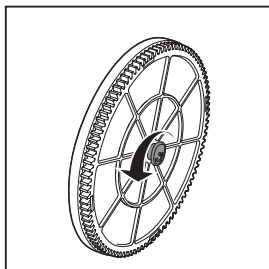

- 3 依次松开加湿滤网边缘的锁定装置，然后将轮盘拆开。

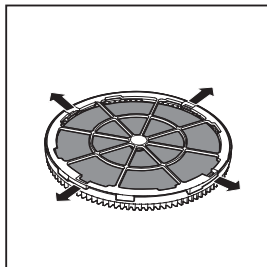

- 4 将用过的纳米云旋转式加湿滤网取出。

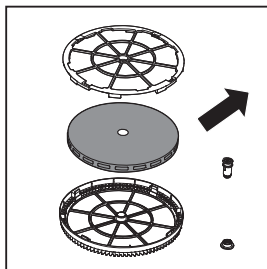

- 5 去除新的纳米云旋转式加湿滤网的所有包装材料。

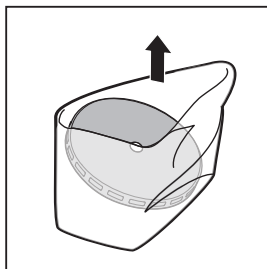

- 6 将新的纳米云旋转式加湿滤网放入加湿滤网轮盘，然后紧固加湿滤网轮盘上的锁定装置。

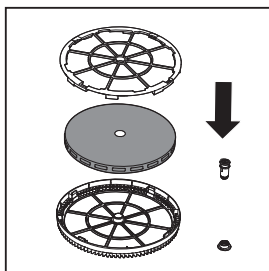

- 7 将加湿滤网轮盘置于滤网支座上。

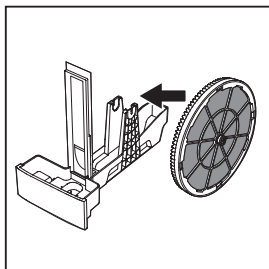

### 注意

- 将加湿滤网轮盘放在滤网支座上时，请确保加湿滤网轮盘上的凸起部位卡入相应的凹槽。

- 8 将蓄水盘和水箱放回产品中。

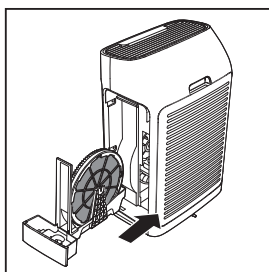

- 9 轻触并按住  3 秒可重置纳米云旋转式加湿滤网使用寿命计数器。

## 更换抗菌滤芯

每年至少更换一次抗菌滤芯，以防细菌在蓄水盘中滋生。

- 1 水平推抗菌滤芯，将其从蓄水盘中取出。

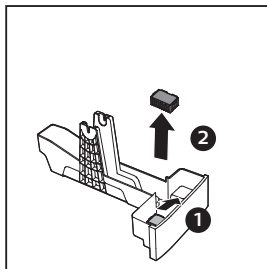

- 2 去除新抗菌滤芯的所有包装材料。

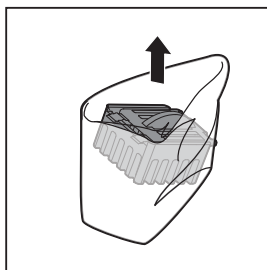

- 3 将新抗菌滤芯放入蓄水盘，水平推入卡槽。

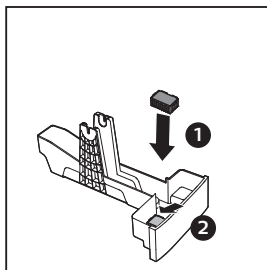



- 4 将蓄水盘和水箱放回产品中。



- 5 轻触并按住  3 秒可重置抗菌滤芯的使用寿命计数器。



## 7 故障排除

本章归纳了您在使用产品时最常遇到的问题。如果您无法根据下面的信息解决问题，请与您所在国家/地区的客户服务中心联系。

问题	可能的解决方法
产品即使接通电源也无法工作。	<ul style="list-style-type: none"> <li>滤网更换指示灯  一直闪烁，但您尚未更换纳米级劲护滤网，产品现在已锁定。在此情况下，更换过滤网并重置过滤网使用寿命计数器。</li> <li>重新注水指示灯  闪烁。请确保水箱安装正确，而且水箱中水量充足。</li> </ul>
产品即使已开启也无法工作。	<ul style="list-style-type: none"> <li>产品正在工作，但按钮没有反应。检查儿童锁是否已打开。</li> </ul>
纳米云旋转式加湿滤网上有一些白色残留物。	<ul style="list-style-type: none"> <li>这些白色残留物被称为水垢，它们由水中的矿物质组成。纳米云旋转式加湿滤网上的水垢将影响加湿性能，但不会损害您的健康。请遵照用户手册中的清洁说明。</li> </ul>
出风口中无空气排出。	<ul style="list-style-type: none"> <li>请将产品插入电源并启动产品。</li> </ul>
出风口排出的气流比之前明显减弱。	<ul style="list-style-type: none"> <li>预过滤网变脏。清洁预过滤网（请参阅“清洁”一章）。</li> <li>请确保已经去除纳米级劲护滤网的所有包装材料。</li> </ul>
达到目标湿度级别需要很长的时间。	<ul style="list-style-type: none"> <li>纳米云自然加湿技术可将看不见的水分子均匀分配到您的房间内。在干燥条件下初次使用，加湿器产生的水分子会被墙壁、家具和房间内的其他物品吸收。外部干燥空气的过度流通也会增加达到目标湿度所需的时间。要优化加湿和净化性能，建议在使用过程中关闭门窗。</li> </ul>
我没有看到产品中有水蒸气冒出。产品是否正在工作？	<ul style="list-style-type: none"> <li>如果雾非常细小，就无法看见。本产品采用纳米云加湿技术，可从出风口区域产生健康潮湿的空气，而不会形成水雾。因此，您看不到雾。</li> </ul>

问题	可能的解决方法
产品散发出一种奇怪的味道。	<ul style="list-style-type: none"> <li>• 前几次使用产品时，其可能会产生塑料味。这是正常的。不过，如果产品发出烧焦的气味，请联系飞利浦经销商或经授权的飞利浦服务中心。</li> <li>• 滤网使用一段时间后可能会散发异味，这是因为吸附了室内的气味导致。建议您将滤网置于阳光底下晾晒后继续使用。如晾晒后异味仍较明显影响使用体验，建议更换滤网。</li> </ul>
产品声音过大。	<ul style="list-style-type: none"> <li>• 您没有拆掉过滤网上的所有包装材料。请确保您已经取下所有包装材料。</li> <li>• 更改风扇速度以降低风扇速度级别。</li> </ul>
我已经更换过了过滤网，但是产品还是提示需要更换过滤网。	<ul style="list-style-type: none"> <li>• 或许您没有正确地轻触并按住定时器/重置按钮 。插入产品电源插头，轻触  打开产品，然后轻触并按住定时器/重置按钮  3 秒钟。</li> </ul>
屏幕上显示“E1”、“E2”、E3”、E4”或“E5”错误代码。	<ul style="list-style-type: none"> <li>• 空气净化器出现故障。请与您所在国家/地区的客户服务中心联系。</li> </ul>

## 8 保修与服务

如果您需要了解信息或有任何疑问，请访问飞利浦网站 [www.philips.com](http://www.philips.com) 或与您所在国家/地区的飞利浦客户服务中心联系（可在全球保修卡中找到其电话号码）。如果您所在的国家/地区没有飞利浦客户服务中心，请向当地的飞利浦经销商求助。

### 订购部件或附件

如果您必须更换部件或需要购买额外的部件，请转到您的飞利浦经销商或访问 [www.philips.com/support](http://www.philips.com/support)。如果获取部件有问题，请与您所在国家/地区的飞利浦客户服务中心联系（可在全球保修卡中找到其电话号码）。

## 9 声明

### 电磁场 (EMF)

本飞利浦产品符合所有有关暴露于电磁场的适用标准和法规。

#### 符合 EMF 标准

Koninklijke Philips N.V. 主要面向广大消费者制造和销售各类产品，包括通常能发射和接收电磁信号的各种电子设备。

飞利浦的主要业务原则之一就是要对自己的产品采取各种必要的健康和安全措施，使其符合所有相应的法律要求，并在制造产品时严格遵照适用的 EMF 标准。

飞利浦致力于开发、生产和销售对人体健康无任何危害的产品。飞利浦确认，据目前的科学证明，如果其产品使用得当，则对人体毫无危害。

长期以来，Philips 始终在国际 EMF 和安全标准的制定工作中扮演着积极的角色，这就使 Philips 总能预知标准的发展趋势，并率先应用到其产品中去。

### 回收

弃置产品时，请不要将它与一般生活垃圾一同丢弃，应将其交给官方指定的回收中心。这样做有利于环保。

请遵循您所在国家/地区的电器及电子产品分类回收规定。正确弃置产品有助于避免对环境和人类健康造成负面影响。



# Contents

<b>1 Important</b>	<b>30</b>	<b>5 Cleaning</b>	<b>44</b>
Safety	30	Cleaning schedule	44
<b>2 You air purifier</b>	<b>33</b>	Cleaning the body of the appliance	44
Product overview	34	Cleaning the air quality sensor	44
Controls overview	35	Cleaning the water tank, water tray and NanoCloud rotary humidification wick	45
<b>3 Get started</b>	<b>36</b>	Cleaning the pre-filter	47
Installing the NanoProtect filter	36	Descaling the NanoCloud rotary humidification wick	48
Preparing for humidification	37	<b>6 Replace the filter and wick</b>	<b>49</b>
<b>4 Use the appliance</b>	<b>39</b>	Understanding the healthy air protect lock	49
Understanding the air quality light	39	Replacing the NanoProtect filter	49
Switching on and off	39	Replacing the NanoCloud rotary humidification wick	50
Setting the humidity level	39	Replacing the anti-bacteria cartridge	52
Switching the operation mode	40	<b>7 Troubleshooting</b>	<b>54</b>
Using the light on/off function	40	<b>8 Guarantee and service</b>	<b>56</b>
Switching the display mode	40	Order parts or accessories	56
Changing the Auto mode setting	41	<b>9 Notices</b>	<b>56</b>
Changing the fan speed	42	Electromagnetic fields (EMF)	56
Setting the timer	42	Recycling	57
Setting the child lock	43		
Water level	43		

# 1 Important

---

## Safety

Read this user manual carefully before you use the appliance, and save it for future reference.

### Danger

- Do not let water or any other liquid or flammable detergent enter the appliance to avoid electric shock and/or a fire hazard.
- Do not clean the appliance with water, any other liquid, or a (flammable) detergent to avoid electric shock and/or a fire hazard.
- Do not spray any flammable materials such as insecticides or fragrance around the appliance.
- The water in the water tank is not suitable for drinking. Do not drink this water and do not use it to feed animals or to water plants. When you empty the water tank, pour the water down the drain.

### Warning

- Check if the voltage indicated on the side of the appliance corresponds to the local power voltage before you connect the appliance.
- If the power cord is damaged, you must have it replaced by Philips, a service center authorized by Philips, or similarly qualified persons in order to avoid a hazard.
- Do not use the appliance if the plug, the power cord, or the appliance itself is damaged.
- This appliance can be used by children aged from 8 years and above and persons with reduced physical, sensory or mental capabilities or lack of experience and knowledge if they have been given supervision or instruction concerning use of the appliance in a safe way and understand the hazards involved.

- Cleaning and user maintenance shall not be made by children without supervision.
- Children should be supervised to ensure that they do not play with the appliance.
- Do not block the air inlet and outlet, e.g. by placing items on the air outlet or in front of the air inlet.
- Leave at least 20cm free space behind and on both sides of the appliance and leave at least 30cm free space above the appliance.
- Do not place anything on top of the appliance.
- Do not place the appliance directly below an air conditioner to prevent condensation from dripping onto the appliance.

### Caution

- This appliance is not a substitute for proper ventilation, regular vacuum cleaning, or use of an extractor hood or fan while cooking.
- If the power socket used to power the appliance has poor connections, the plug of the appliance becomes hot. Make sure that you plug the appliance into a properly connected power socket.
- Always place and use the appliance on a dry, stable, level, and horizontal surface.
- Make sure all filters are properly installed before you switch on the appliance.
- Only use the original Philips filters specially intended for this appliance. Do not use any other filters.
- Avoid knocking against the appliance (the air inlet and outlet in particular) with hard objects.
- Do not insert your fingers or objects into the air outlet or the air inlet to prevent physical injury or malfunctioning of the appliance.

- Do not use this appliance when you have used indoor smoke-type insect repellents or in places with oily residues, burning incense, or chemical fumes.
- Do not use the appliance near gas appliances, heating devices or fireplaces.
- Always unplug the appliance after use and before filling water, cleaning, or carrying out other maintenance.
- Do not use the appliance in a room with major temperature changes.
- To prevent interference, place the appliance at least 2m away from electrical appliances that use airborne radio waves such as TVs, radios, and radio-controlled clocks.
- When the appliance is not used for a long time, bacteria may grow on the filters. Check the filters after a long period of disuse. If the filters are very dirty, replace them (see the chapter "Replace the filter and wick").
- The appliance is only intended for household use under normal operating conditions.
- Do not use the appliance in wet surroundings or in surroundings with high ambient temperatures, such as the bathroom, toilet, or kitchen.
- The appliance does not remove carbon monoxide (CO) or radon (Rn). It cannot be used a safety device in case of accidents with combustion processes and hazardous chemicals.
- Only fill the water tank with cold tap water. Do not use ground water or hot water.
- Do not put any substance other than water in the water tank. Do not put fragrance in the water tank.



- If you do not use the humidification function for a long time, clean the water tank and NanoCloud rotary humidification wick tray, and air dry the NanoCloud rotary humidification wick.
- If you need to move the appliance, disconnect the appliance from the power supply first. Then empty or remove the water tank and water tray. Carry the appliance horizontally by the handles on both sides of the appliance.
- Unplug the appliance during filling and cleaning.

## 2 You air purifier

Congratulations on your purchase, and welcome to Philips!

To fully benefit from the support that Philips offers, register your product at [www.Philips.com/welcome](http://www.Philips.com/welcome).

The Philips air purifier brings fresh, humidified air to your house for the health of your family. It offers you advanced evaporation system with NanoCloud technology, using a special humidification filter which adds H<sub>2</sub>O molecules to the dry air, and produces healthy humid air without formation of water mist. Its humidification filter retains bacteria, calcium and other particles from the water. It delivers only pure humidified air in your home. No more dry air in the winter season or from the air conditioning.

Read this user manual carefully before you use the appliance, and save it for future reference.

## Product overview

**A** Control panel

**B** Water tank

**C** Anti-bacteria cartridge

**D** Wick support

**E** Water tray

**F** Omni wheels  
(for **AC4924/AC4926** only)

**G** Wick wheel

For **AC4924/AC4926**:  
NanoCloud rotary humidification  
wick (**FY4445**)

**H** For **AC3822 /AC3824**:  
NanoCloud rotary humidification  
wick (**FY3435**)

**I** Back side cover

**J** Pre-filter





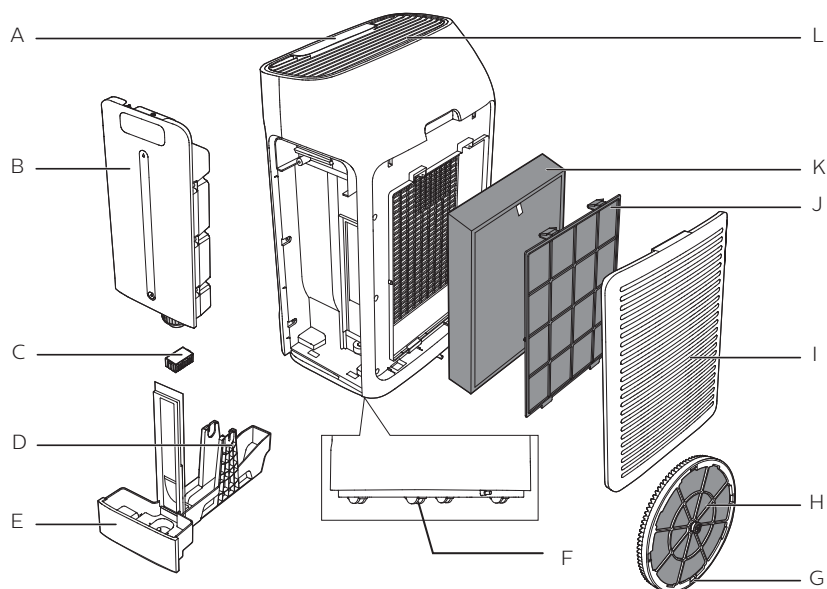



For **AC4924/AC4926**:  
NanoProtect filter Pro S3(**FY3137**)  
**K** For **AC3822 /AC3824**:  
NanoProtect filter Pro S2(**FY2428**)

**L** Air outlet











## Controls overview

### Control buttons

-  Power on/off button
-  Child lock button
-  Auto mode button
-  Fan speed button
-  Humidity setting button
-  Light dimming button
-  2-in-1 mode on/off button
-  Timer/Reset button

### Display panel:

-  Sleep mode
-  Auto mode
-  Allergen mode
-  Purification ONLY mode
-  2-in-1 mode
-  Filter replacement alert
-  Water refill alert
-  Pre-filter and wick cleaning alert
- PM2.5** PM2.5 display
- IAI** Indoor Allergen Index

English

## Control buttons



## Display panel

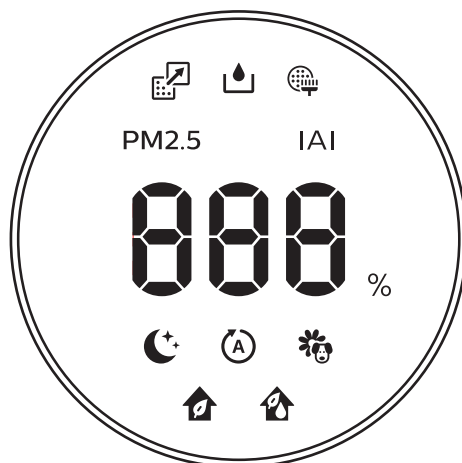

## 3 Get started

### Installing the NanoProtect filter

Before using the appliance, remove all packaging materials of the filter and place it into the appliance described as follows:

#### Note

- Make sure that the side with the tag is pointing towards you.

- 1 Pull the top part of the back panel towards you to release it from the appliance.

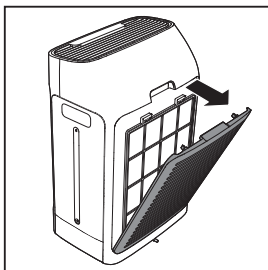

- 2 Press the two clips down and pull the pre-filter towards you.

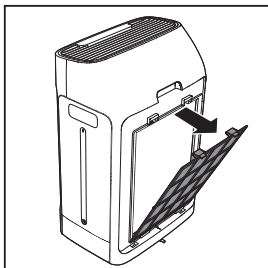

- 3 Remove all packaging materials of the NanoProtect filter.

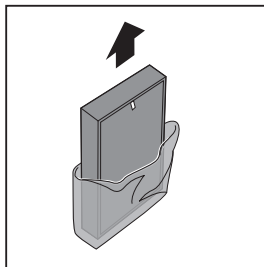

- 4 Place the NanoProtect filter back into the appliance.

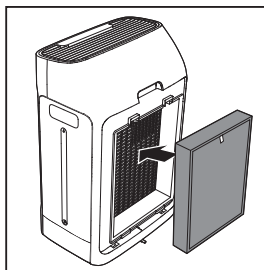

- 5 Put the pre-filter back into the appliance, mount the pre-filter onto the bottom of the appliance first, and then push the clips on the top of pre-filter against the appliance.

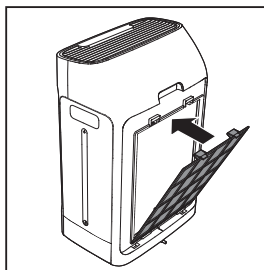

- 6 To reattach the back cover, mount the panel onto the bottom of the appliance first, and then push the top of the panel against the appliance.

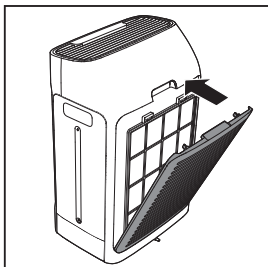

## Preparing for humidification

- 1 Pull out the water tank.

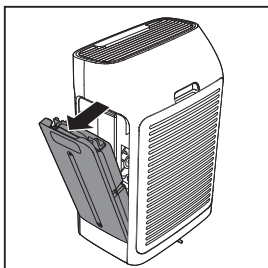

- 2 Lift the water tray upwards and pull it out horizontally.

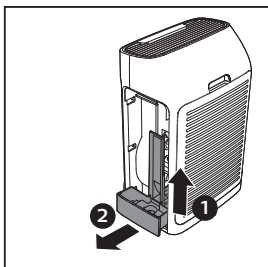

- 3 Remove all packaging material of the NanoCloud rotary humidification wick.

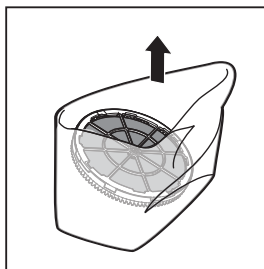

### Note

- The humidification wick has been assembled on the wick wheel upon purchase.

- 4 Place the wick wheel on the wick support.

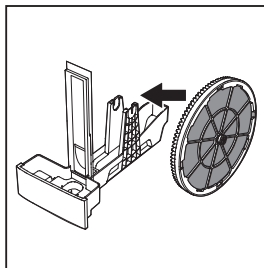

### Note

- When placing the wick wheel on the wick support, make sure that the projections on the wick wheel falls into the corresponding grooves.

- 5 Place the water tray back into the appliance.

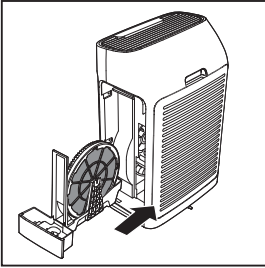

- 8 Turn the top cap clockwise to tightly lock it onto the water tank.

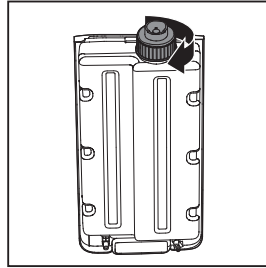

- 6 Turn the top cap of the water tank anti-clockwise to unscrew it.

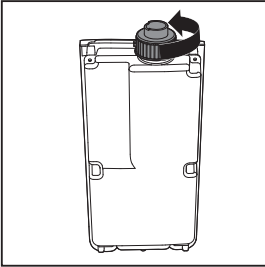

- 9 Place the water tank back into the appliance.

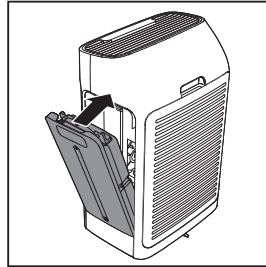

- 7 Fill the water tank with cold tap water.

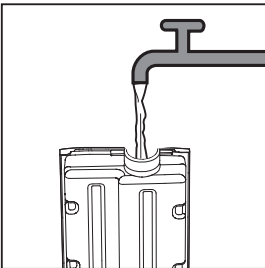



## 4 Use the appliance

### Understanding the air quality light

PM2.5 level	Air quality light color	Air quality level
≤35	Blue	Good
36-75	Blue-Purple	Fair
76-115	Purple-Red	Poor
>115	Red	Very poor

The air quality light automatically goes on when the appliance is switched on, and lights up all colors in sequence. In a short time the air quality sensors select the color that corresponds to the ambient air quality.

### Switching on and off

- 1 Put the plug in the power socket.  
↳ The appliance beeps.
- 2 Touch  to switch on the appliance.  
↳ The appliance operates under the 2-in-1 mode by default with  displayed on the screen.  
↳ When the appliance is warming up, "----" displays on the screen. After measuring the particulate matter only in the air, the appliance shows the PM2.5 level and operates in the auto mode by default.  
↳ After measuring the air quality for approximately 30 seconds, the air quality sensor automatically selects the appropriate air quality light color.

- 3 Touch and hold  for 3 seconds to switch off the appliance.

#### Note

- After the appliance is switched off by the on/off button , if the plug is still in the power socket, the appliance will operate under the previous settings when it is switched on again.

### Setting the humidity level

- 1 Touch the humidity button  repeatedly to set the desired air humidity to 40%, 50%, 60% or "• •".

#### Note

- When the humidity level "• •" is chosen, the appliance will keep humidifying the room until the ambient humidity level reaches 70%RH.

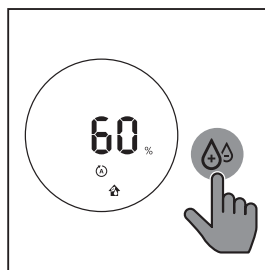

#### Note



- When the target humidity level is reached, the wick wheel will stop rotating. It will start rotating again when the humidity drops below the target level.
- If you want to increase the humidity level quickly, you can select a higher fan speed.

## Switching the operation mode

The appliance has two operation modes, the purification ONLY mode and the 2-in-1 mode.

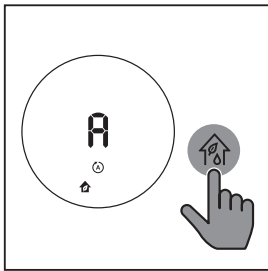

- Touch the mode selection button  repeatedly to switch between the purification ONLY mode and the 2-in-1 mode.



- ↳  displays on the screen when the appliance operates in the purification ONLY mode.
- ↳  displays on the screen when the appliance operates in the 2-in-1 mode.

## Using the light on/off function

With the light dimming button, you can switch on or off the air quality light, the display screen and the function indicator if desired.

- 1 Touch the light dimming button  once, the air quality light will be dimmed.
- 2 Touch the light dimming button  again, the air quality light and the display panel will be turned off.
- 3 Touch the light dimming button  for the third time, all lights will be on again.

## Switching the display mode

The appliance has three display modes, PM2.5 display, IAI display and humidity level display.

### PM2.5

**AeraSense** sensing technology accurately detects and quickly respond to even the slightest particle change in the air. It provides you with reassurance with real-time PM2.5 feedback.

### IAI

The professional-grade **AeraSense** sensor detects the level of indoor air allergen and with numerical feedback from 1 to 12 the potential risk level of indoor air allergens can be displayed. 1 indicates best air quality.

### Note

- The appliance operates in PM2.5 display mode by default.

- 1 Touch and hold  for 3 seconds to switch to IAI display.

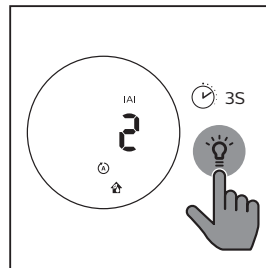

- ↳ IAI indicator and the actual IAI level display on the screen.



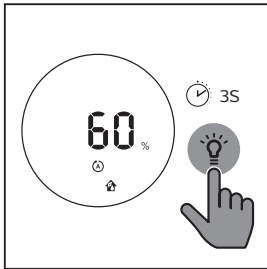

- 2 Touch and hold  for 3 seconds twice to switch to actual humidity level display.

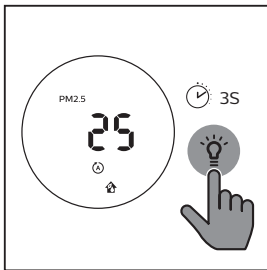

- 3 Touch and hold  for 3 seconds to switch to PM2.5 display.
  - ↳ PM2.5 indicator and the actual PM2.5 level display on the screen.





## Changing the Auto mode setting

You can choose the Auto mode () , the Allergen mode () and the Sleep mode ().

### Auto mode

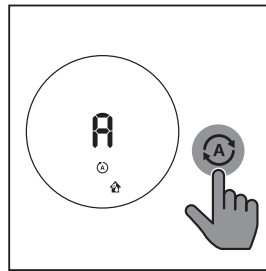

In auto mode, the appliance selects the fan speed in accordance with the ambient air humidity and air quality.

- Touch the Auto mode button () to select Auto mode.
  - ↳ Auto () and () display on the screen.
  - ↳ The appliance operates in Auto mode by default.



### Allergen mode

The extra-sensitive allergen mode is designed to react to even a small change in allergen levels in the surrounding air.

- Touch the Auto mode button () to select the Allergen mode.
  - ↳ Auto () and () display on the screen.

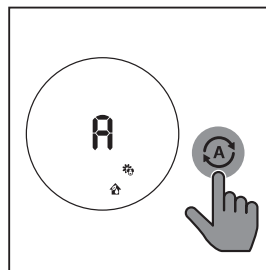

## Sleep (SL)

In Sleep mode, the air purifier operates quietly on a very low speed.

- Touch the Auto mode button (A) to select the Sleep mode (SL).  
↳ Sleep (SL) and ☾ display on the screen.

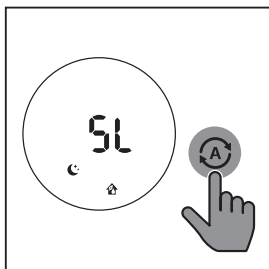

### Note

- All lights will go off except ☾ if no buttons are touched after one minute.
- You can turn on the lights manually by touching any buttons.

## Changing the fan speed

There are several fan speeds available.

### Manual

- Touch the fan speed button (⊗) repeatedly to select the desired fan speed (1, 2 or 3).

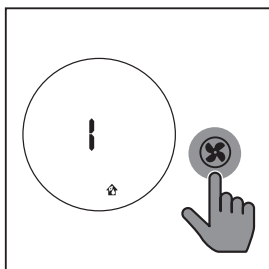

## Turbo (t)

In Turbo mode, the air purifier operates on the highest speed.

- Touch the fan speed button (⊗) to select the Turbo mode (t).

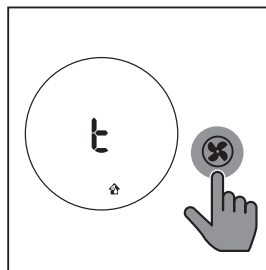

## Setting the timer

With the timer, you can let the appliance operate for a set number of hours. When the set time has elapsed, the appliance will automatically switch off.

- Touch the Timer/Reset button (⌚) repeatedly to choose the number of hours you want the appliance to operate.  
↳ The timer is available from 1 to 12 hours.

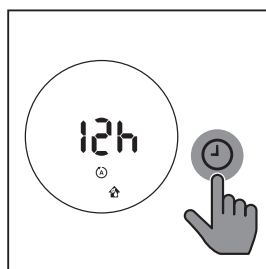

- To deactivate the timer function, touch the Timer/Reset button (⌚) repeatedly until "----" displays on the screen.

## Setting the child lock

- 1 Touch and hold the child lock button  for 3 seconds to activate child lock.
  - ↳ **L** displays on the screen for 3 seconds.
  - ↳ When the child lock is on, all the other buttons are not responsive.

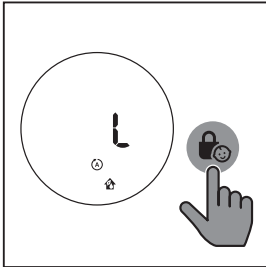

- 2 Touch and hold the child lock button  for 3 seconds again to deactivate child lock.
  - ↳ **UL** displays on the screen for 3 seconds.

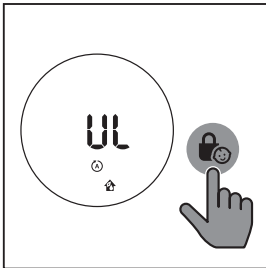

## Water level

The water level in the water tank is visible through the water level window on the water tank.

When there is not enough water in the water tank, the water refill light  flashes to indicate that you have to refill the water tank.

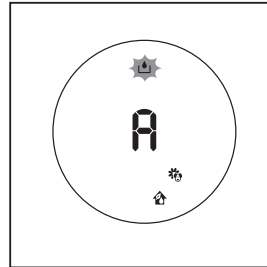

### Note

- When there is no water in the water tank, the wick wheel will stop rotating. When the water tank is refilled with water, the wick wheel will start rotating again.

## 5 Cleaning

### Note

- Always unplug the appliance before cleaning.
- Never immerse the appliance in water or any other liquid.
- Never use abrasive, aggressive, or flammable cleaning agents such as bleach or alcohol to clean any part of the appliance.
- Only the pre-filter and NanoCloud rotary humidification wick are washable. The NanoProtect filter is not washable nor vacuum cleanable.

### Cleaning schedule

Frequency	Cleaning method
When necessary	Wipe the surface of the appliance with a soft dry cloth.
Every week	Rinse the water tank, the water tray and the NanoCloud rotary humidification wick.
When the cleaning icon  lights up and FO displays on the screen.	Clean the pre-filter.
	Descalcify the NanoCloud rotary humidification wick with water and white vinegar (5% acetic acid) or water and citric acid.

### Cleaning the body of the appliance

Regularly clean the inside and outside of the appliance to prevent dust from collecting.

- 1 Wipe away dust with a soft dry cloth from the body of the appliance.
- 2 Clean the air outlet with a soft dry cloth.

### Cleaning the air quality sensor

Clean the air quality sensor every 2 months for optimal functioning of the purifier. Clean them more frequently if you use the purifier in a dusty environment.

### Note

- When the humidity level in the room is very high, it is possible that condensation develops on the air quality sensor. As a result, the air quality light may indicate that the air quality is bad even though it is good. In this case you have to clean the air quality sensor or use one of the manual speed settings.

- 1 Clean the air quality sensor inlet and outlet with a soft brush.

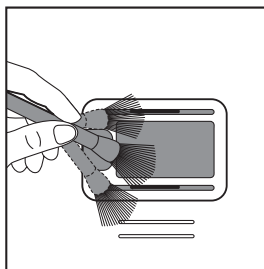

- 2 Open the air quality sensor cover.

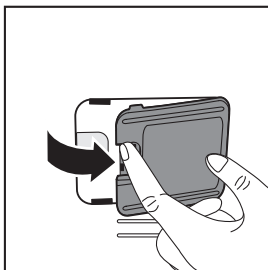

- 3 Clean the air quality sensor, the dust inlet and the dust outlet with a lightly moistened cotton swab.

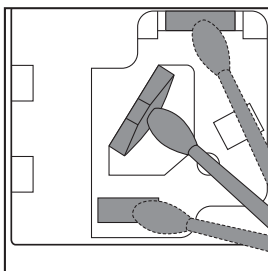

- 4 Dry them with a dry cotton swab.  
5 Reattach the air quality sensor cover.

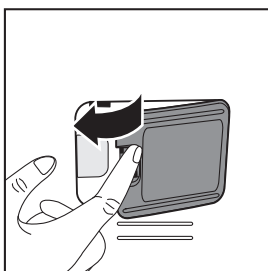

## Cleaning the water tank, water tray and NanoCloud rotary humidification wick

### Note

- Cleaning the water tank, water tray and NanoCloud rotary humidification wick every week to keep them hygienic.

- 1 Pull out the water tank.

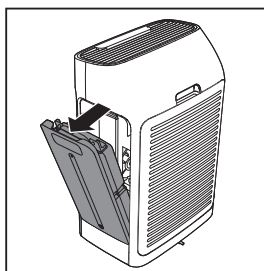

- 2 Lift the water tray upwards and pull it out horizontally.

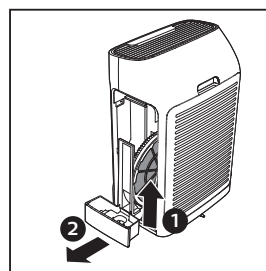

- 3 Take the wick wheel off the wick support.

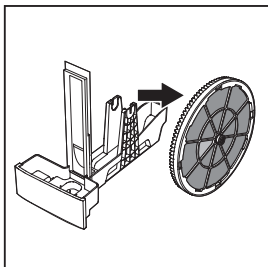

- 4 Rinse the water tank, water tray and NanoCloud rotary humidification wick under a running tap.

**Note**

- Do not take the NanoCloud rotary humidification wick off the wheel during cleaning.
- Do not scrub the NanoCloud rotary humidification wick or place it under direct sunlight.
- If necessary, use a mild detergent to clean the water tank and water tray. In this case, rinse the water tank and water tray thoroughly.

- 5 Wipe the outside of the water tank and water tray dry.
- 6 Place the wick wheel on the wick support.

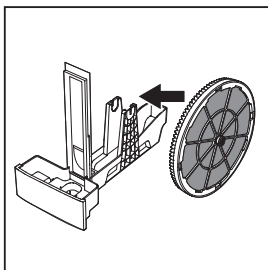

**Note**

- When placing the wick wheel on the wick support, make sure that the projections on the wick wheel falls into the corresponding grooves.

- 7 Place the water tray back into the appliance.

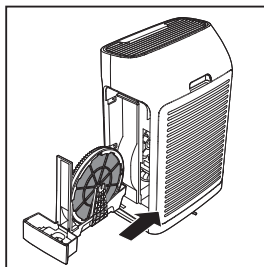

- 8 Place the water tank back into the appliance.

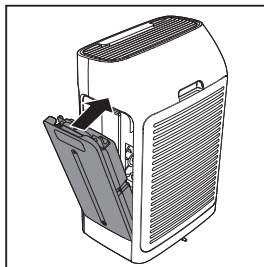

## Cleaning the pre-filter

### Note

- If the pre-filter is damaged, worn or broken, do not use. Visit [www.philips.com/support](http://www.philips.com/support) or contact the Consumer Care Center in your country.

Filter alert light status	Follow this
FO displays on the screen and wick& pre-filter cleaning alert  goes on	Clean the pre-filter

- 1 Pull the top part of the back panel towards you to release it from the appliance.

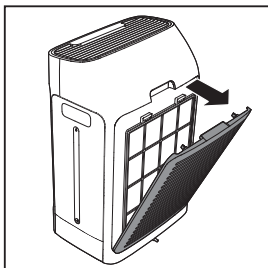

- 2 To remove the pre-filter, press the two clips down and pull the filter towards you.

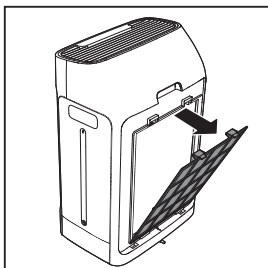

- 3 Wash the pre-filter under a running tap. If the pre-filter is very dirty, use a soft brush to brush away the dust.

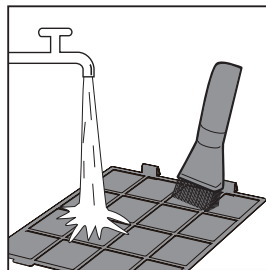

- 4 Air dry the pre-filter.

### Note

- Make sure that the pre-filter is completely dry. If it is still wet, bacteria may multiply in it and shorten the lifetime of the pre-filter.

- 5 After the pre-filter is completely dry, place it back into the back panel.

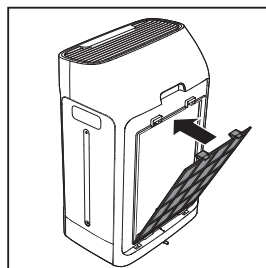

- 6 Touch and hold  for 3 seconds to reset the pre-filter cleaning time.

## Descaling the NanoCloud rotary humidification wick

Filter alert light status	Follow this
F0 displays on the screen and wick & pre-filter cleaning alert  goes on	Descal the NanoCloud rotary humidification wick

- 1 Pull out the water tank.

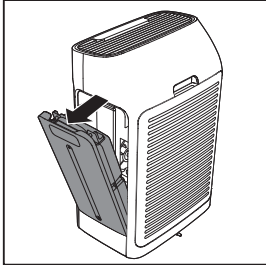

- 2 Lift the water tray upwards and pull it out horizontally.

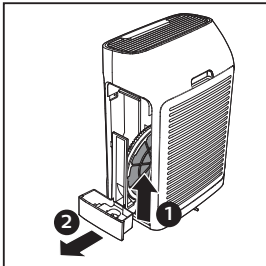

- 3 Take the wick wheel off the wick support.

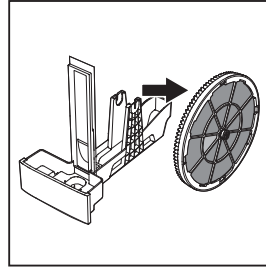

- 4 Soak the NanoCloud rotary humidification wick in cleansing agent (e.g. diluted white vinegar, Citric acid solution) for two hours.

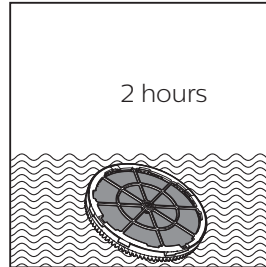

### Note

- Please use mid or acid cleanser
- White vinegar (5% acetic acid) mix with equal amount of water
- 24g citric acid mix with 4L water
- If there are white deposits (limescale) on the filter, make sure that the side with the white deposits is immersed in the water.
- Do not take the NanoCloud rotary humidification wick off the wheel during descaling.



- 5 Rinse the NanoCloud rotary humidification wick under the tap to rinse away vinegar or citric acid residues. During rinsing, turn the wick so that both front and back are rinsed.

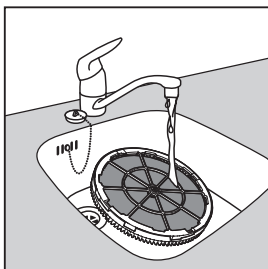

- 6 Air dry the NanoCloud rotary humidification wick.

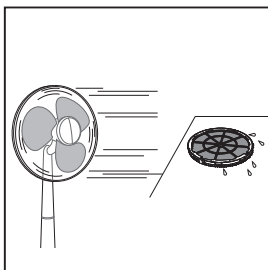

#### Note

- Do not put the NanoCloud rotary humidification wick under direct sunlight.

- 7 Touch and hold  for 3 seconds to reset the NanoCloud rotary humidification wick cleaning time.

## 6 Replace the filter and wick

### Understanding the healthy air protect lock

This appliance is equipped with the healthy air protect lock to make sure that the Nano protect filter and the humidification wick are in optimal condition when the appliance is operating. When the Nano protect filter and the humidification wick are almost expired, the replacement light  starts to flash to indicate that they need to be replaced.

If you do not replace the filter and wick in time, the appliance will stop operating and get locked.

### Replacing the NanoProtect filter

#### Note

- The filter is not washable or reusable.
- Always turn off the air purifier and unplug from the electrical outlet before replacing the filters.

Filter alert light status	Follow this
A3 is displayed and the filter replacement light  flashes on the screen.	Replace the NanoProtect filter Pro S3 (for AC4924/AC4926), NanoProtect filter Pro S2 (for AC3822/AC3824)

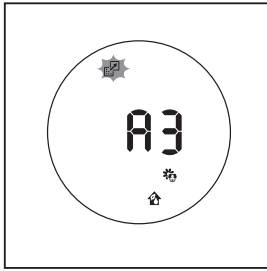

- 1 Remove the used NanoProtect filter from the appliance.

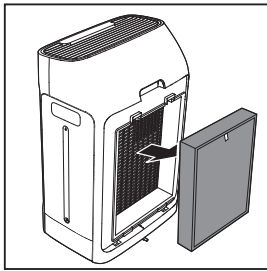

**Note**

- Do not touch the pleated filter surface, or smell the filter as it has collected pollutants from the air.
- Wash your hands after disposing of the used filters.

- 2 Remove all packaging material of the new NanoProtect filter.

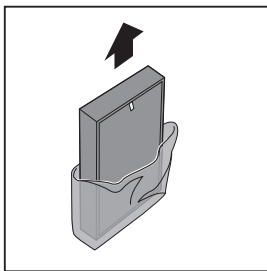

- 3 Place the new NanoProtect filter into the appliance.

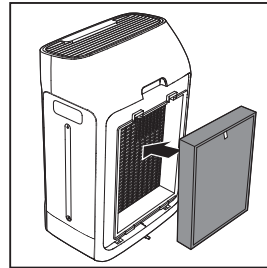

- 4 Touch and hold  for 3 seconds to reset the NanoProtect filter lifetime counter.

## Replacing the NanoCloud rotary humidification wick

Filter alert light status	Follow this
F1 is displayed and the filter replacement light  flashes on the screen.	Replace the NanoCloud rotary humidification wick

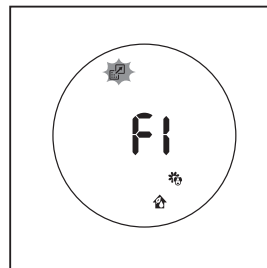

- 1 Take the wick wheel off the wick support.

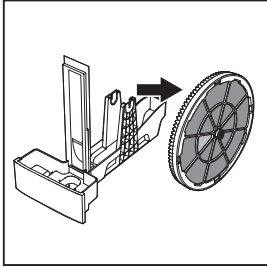

- 2 Grip the shaft screw on the other side of the wheel, rotate it anticlockwise to release the wick from the wheel.

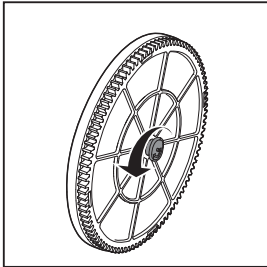

- 3 Unfasten the locks on the edge of the wheel successively to disassemble the wick wheel.

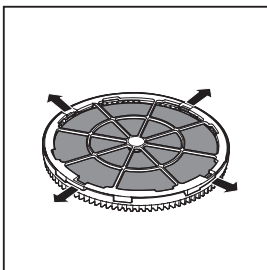

- 4 Take the used NanoCloud rotary humidification wick out.

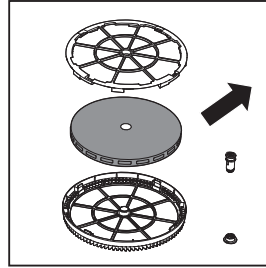

- 5 Remove all packaging material of the new NanoCloud rotary humidification wick.

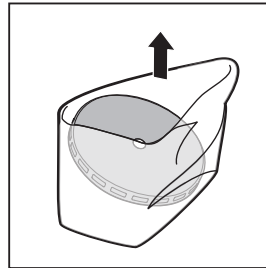

- 6 Place the new NanoCloud rotary humidification wick in the wick wheel, and then fasten the locks on the wick wheel.

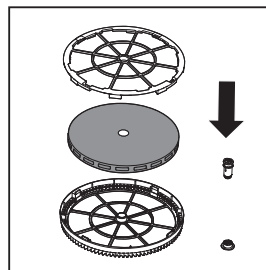

- 7 Place the wick wheel on the wick support.

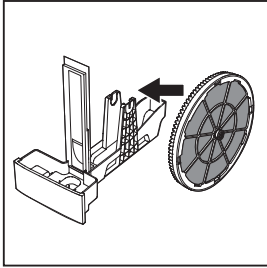

**Note**

- When placing the wick wheel on the wick support, make sure that the projections on the wick wheel falls into the corresponding grooves.

- 8 Place the water tray and water tank back into the appliance.

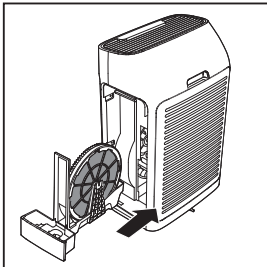

- 9 Touch and hold  for 3 seconds to reset the NanoCloud rotary humidification wick lifetime counter.

## Replacing the anti-bacteria cartridge

Replace the anti-bacteria cartridge at least once a year to prevent bacteria from growing in the water tray.

- 1 Slide the anti-bacteria cartridge horizontally and take it from the water tray.

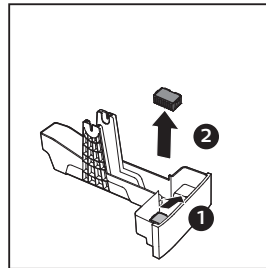

- 2 Remove all packaging materials of the new anti-bacteria cartridge.

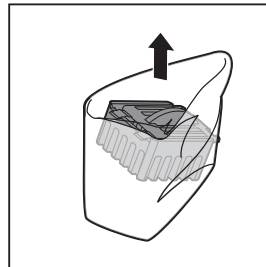

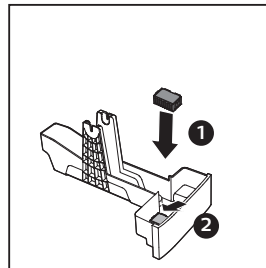

- 3 Place the new anti-bacteria cartridge into the water tray and push it horizontally into the slot.





- 4 Place the water tray and water tank back into the appliance.
- 5 Touch and hold  for 3 seconds to reset the lifetime counter of the anti-bacteria cartridge.

## 7 Troubleshooting

This chapter summarizes the most common problems you could encounter with the appliance. If you are unable to solve the problem with the information below, contact the Consumer Care Center in your country.

Problem	Possible solution
<p>The appliance does not work even though it is plugged in.</p>	<ul style="list-style-type: none"> <li>• The filter replacement light  has been flashing but you have not replaced the NanoProtect filter, and the appliance is now locked. In this case, replace the filter and reset the filter lifetime counter.</li> <li>• The water refill light  flashes. Make sure the water tank is properly installed and there is enough water in the water tank.</li> </ul>
<p>The appliance does not work even though it is switched on.</p>	<ul style="list-style-type: none"> <li>• The appliance is working but the buttons are not responsive. Check if the child lock is on.</li> </ul>
<p>There are some white deposits on the NanoCloud rotary humidification wick.</p>	<ul style="list-style-type: none"> <li>• The white deposits are called scale and they consist of minerals from the water. Scale on the NanoCloud rotary humidification wick affects the humidifying performance, however it does not harm your health. Follow the cleaning instructions in the user manual.</li> </ul>
<p>No air comes out of the air outlet.</p>	<ul style="list-style-type: none"> <li>• Plug the appliance into the power supply and switch on.</li> </ul>
<p>The airflow that comes out of the air outlet is significantly weaker than before.</p>	<ul style="list-style-type: none"> <li>• The pre-filter is dirty. Clean the pre-filter (see the chapter "Cleaning").</li> <li>• Make sure that you have removed all packaging material of the NanoProtect filter.</li> </ul>

Problem	Possible solution
It takes a long time to reach the target humidity level.	<ul style="list-style-type: none"> <li>NanoCloud technology evenly distributes invisible water vapour into your room. In dry conditions moisture from the humidifier will be absorbed by walls, furniture, and other items in your room. Ventilation of dry outside air will also increase the time it takes to reach the target humidity. To optimize humidification and purification performance, it's recommended to close doors and windows during use.</li> </ul>
I do not see water vapor coming out of the appliance. Is it working?	<ul style="list-style-type: none"> <li>When mist is very fine, it is invisible. The appliance has a NanoCloud humidification technology, which produces healthy humid air from the outlet area without formation of water mist. Therefore, you cannot see the mist.</li> </ul>
The appliance produces a strange smell.	<ul style="list-style-type: none"> <li>The first few times you use the appliance, it may produce a plastic smell. This is normal. However, if the appliance produces a burnt smell, contact your Philips dealer or an authorized Philips service centre.</li> <li>The filter may produce smell after being used for a while because of the absorption of indoor air. Remove the filter and place it where it has direct sunlight and ventilation for several hours. Re-install and try using it again. If the odor remains, please replace the filter.</li> </ul>
The appliance is extra loud.	<ul style="list-style-type: none"> <li>You have not removed all packaging material of the filters. Make sure that you have removed all packaging material.</li> <li>Change the fan speed to lower fan speed level.</li> </ul>
The appliance still indicates that I need to replace a filter, but I already did.	<ul style="list-style-type: none"> <li>Perhaps you did not touch and hold the Timer/Reset button  correctly. Plug in the appliance, touch  to switch on the appliance, and touch and hold the Timer/Reset button  for 3 seconds.</li> </ul>
Error codes "E1", "E2", "E3", "E4" or "E5" displays on the screen.	<ul style="list-style-type: none"> <li>The appliance has malfunctions. Contact the Consumer Care Center in your country.</li> </ul>

## 8 Guarantee and service

If you need information or if you have a problem, please visit the Philips website at [www.philips.com](http://www.philips.com) or contact the Philips Consumer Care Center in your country (you find its phone number in the worldwide guarantee leaflet). If there is no Consumer Care Centre in your country, go to your local Philips dealer.

---

### Order parts or accessories

If you have to replace a part or want to purchase an additional part, go to your Philips dealer or visit [www.philips.com/support](http://www.philips.com/support).

If you have problems obtaining the parts, please contact the Philips Consumer Care Center in your country (you can find its phone number in the worldwide guarantee leaflet).

## 9 Notices

---

### Electromagnetic fields (EMF)

This Philips appliance complies with all applicable standards and regulations regarding exposure to electromagnetic fields.

---

### Compliance with EMF

Koninklijke Philips N.V. manufactures and sells many products targeted at consumers, which, like any electronic apparatus, in general have the ability to emit and receive electromagnetic signals.

One of Philips' leading Business Principles is to take all necessary health and safety measures for our products, to comply with all applicable legal requirements and to stay well within the EMF standards applicable at the time of producing the products.

Philips is committed to develop, produce and market products that cause no adverse health effects. Philips confirms that if its products are handled properly for their intended use, they are safe to use according to scientific evidence available today.

Philips plays an active role in the development of international EMF and safety standards, enabling Philips to anticipate further developments in standardization for early integration in its products.



---

## Recycling

Do not throw away the product with the normal household waste at the end of its life, but hand it in at an official collection point for recycling. By doing this, you help to preserve the environment.

Follow your country's rules for the separate collection of electrical and electronic products. Correct disposal helps prevent negative consequences for the environment and human health.

# PHILIPS

## 产品保用卡

### 保修及服务：

此产品是一件设计精良，用高品质元件制造之家用电器，在正常使用及保养下应能发挥其优越性能。在购买日期后二年内，若发生任何因制造工艺或元器件造成之损坏，飞利浦中国维修服务中心将为持证用户提供免费门市维修服务，视情况更换零件或整个产品。

无论在保期中或保期后，只要飞利浦正式行销该产品的任何国家皆可获得维修服务。

若飞利浦在当地无行销该项产品，飞利浦同样提供维修服务，但可能因未储备所需零件，维修时间可能较长，敬请谅解。请联络当地飞利浦经销商，或飞利浦服务部门。

若您需洽询相关资讯，或遇到困难事项时，请联络当地飞利浦维修服务中心，或向飞利浦服务热线咨询。

中国顾客服务热线：4008 800 008

(用户需承担本地通话费)。

网址：<http://www.philips.com.cn>

### 网上会员注册与产品注册：

- 1) 登陆 <http://www.philips.com.cn/welcome>
- 2) 点击“创建新账户”，创建您的飞利浦账号
- 3) 点击“注册产品”，通过产品名称或产品型号查找产品，完成产品注册

### 服务须知

需要此产品的售后服务，

拨打服务热线：4008 800 008

在维修服务过程中有任何意见，

欢迎致函飞利浦(中国)投资有限公司解决疑难。

### 保修条例：

- \* 在购买日期后二年内，凡经本公司特约维修站人员确认为正常使用情况下，因制造工艺或元器件造成之损坏，您都将获得免费保修服务。
  - \* 此免费服务不包括需时常更换的易耗零配件（吸尘机纸袋，布袋，空气清新机滤网，滤芯，活性炭，咖啡壶过滤网）及附件（如须刀网膜、刀头，咖啡杯，食品加工机杯/刀具等），辅助装置，运输费及维修人员上门服务费。
  - \* 用户请保留此联。
  - \* 维修时请携同此证及发票正本。
  - \* 此证若经涂改即作废。
  - \* 此证须连同发票正本使用方为有效。
  - \* 以下情况将不能获得免费服务
1. 使用不当引起的人为损坏，例如接入不适当电源、使用不适当配件、不适当之安装、不依说明书使用、错误使用或疏忽而造成损坏等。因运输及其他意外而造成之损坏。非经本公司认可之维修和改装。其他因不可抗力（如自然灾害、电压异常等）造成的损坏。
  2. 一般家庭以外使用（如工业、商业用）而造成的损坏。
  3. 正常使用引起的产品老化、磨损等，但不影响产品的正常使用。
- \* 保修证作为在规定期限及条件之内进行免费维修的保证，并不限制消费者的法定权利。
  - \* 飞利浦提供 2 年全球联保服务，在产品由飞利浦正式销售的所有国家中，都提供保修和保修期满的维修服务。要求保修时，您需提供发票正本，且请求保修的日期还在保修期限之内。

飞利浦(中国)投资有限公司

上海市静安区灵石路 718 号 A1 幢

## 产品中有害物质的名称及含量

部件名称	有害物质					
	铅(Pb)	汞(Hg)	镉(Cd)	六价铬 (Cr(VI))	多溴联苯 (PBB)	多溴二苯醚 (PBDE)
主电路板组件	×	○	○	○	○	○
电源电路板组件	×	○	○	○	○	○
传感器板组件	×	○	○	○	○	○
电机组件	×	○	○	○	○	○

本表格依据SJ/T 11364的规定编制。  
○ 表示该有害物质在该部件所有均质材料中的含量均在GB/T 26572规定的限量要求以下。  
× 表示该有害物质至少在该部件的某一均质材料中的含量超出GB/T 26572规定的限量要求。

\*该表格中所显示的“有害物质”在产品正常使用情况下不会对人身和环境产生任何伤害。

\*该表格中所显示的“有害物质”及其存在的部件向消费者和回收处理从业者提供相关物质的存在信息，有助于产品废弃时的妥善处理。

保留备用

出版日期：2018-05-15

产品：飞利浦二合一空气净化加湿一体机 AC3822  
型号：KJ300F-C09  
额定电压：220V~  
额定频率：50Hz  
额定输入功率：45 W  
生产日期：请见产品本体  
产地：中国广东佛山



飞利浦（中国）投资有限公司  
上海市静安区灵石路 718 号 A1 幢  
全国顾客服务热线：4008 800 008

本产品根据国标 GB4706.1-2005，  
GB4706.45-2008，GB4706.48-2009 制造

## 产品性能指标

目标污染物	洁净空气量(CADR)	累计净化量(CCM)	净化能效等级
颗粒物	335 m <sup>3</sup> /h	P4	高效级
甲醛	200 m <sup>3</sup> /h	F3	高效级
甲苯	100 m <sup>3</sup> /h	-	高效级
噪声(声功率级)	62 dB (A)	适用面积*	23 - 40 m <sup>2</sup>

\*适用面积是按照国标GB/T18801-2015根据颗粒物洁净空气量计算得出  
以上性能指标数据是在第三方试验室按照国标GB/T18801-2015，以特定的  
烟尘颗粒物或气态污染物为目标污染物测试得出

产品：飞利浦二合一空气净化加湿一体机 AC3824  
型号：KJ300F-C10  
额定电压：220V~  
额定频率：50Hz  
额定输入功率：45 W  
生产日期：请见产品本体  
产地：中国广东佛山



飞利浦（中国）投资有限公司  
上海市静安区灵石路 718 号 A1 幢  
全国顾客服务热线：4008 800 008

本产品根据国标 GB4706.1-2005，  
GB4706.45-2008，GB4706.48-2009 制造

## 产品性能指标

目标污染物	洁净空气量(CADR)	累计净化量(CCM)	净化能效等级
颗粒物	335 m <sup>3</sup> /h	P4	高效级
甲醛	200 m <sup>3</sup> /h	F3	高效级
甲苯	100 m <sup>3</sup> /h	-	高效级
噪声(声功率级)	62 dB (A)	适用面积*	23 - 40 m <sup>2</sup>

\*适用面积是按照国标GB/T18801-2015根据颗粒物洁净空气量计算得出  
以上性能指标数据是在第三方试验室按照国标GB/T18801-2015，以特定的  
烟尘颗粒物或气态污染物为目标污染物测试得出

产品：飞利浦二合一空气净化加湿一体机 AC4924  
型号：KJ400F-D01  
额定电压：220V ~  
额定频率：50Hz  
额定输入功率：73 W  
生产日期：请见产品本体  
产地：中国广东佛山



飞利浦（中国）投资有限公司  
上海市静安区灵石路 718 号 A1 幢  
全国顾客服务热线：4008 800 008

本产品根据国标 GB4706.1-2005，  
GB4706.45-2008，GB4706.48-2009 制造

## 产品性能指标

目标污染物	洁净空气量(CADR)	累计净化量(CCM)	净化能效等级
颗粒物	410 m <sup>3</sup> /h	P4	高效级
甲醛	200 m <sup>3</sup> /h	F4	高效级
甲苯	100 m <sup>3</sup> /h	-	高效级
噪声(声功率级)	65 dB (A)	适用面积*	29 - 49 m <sup>2</sup>

\*适用面积是按照国标GB/T18801-2015根据颗粒物洁净空气量计算得出  
以上性能指标数据是在第三方试验室按照国标GB/T18801-2015，以特定的  
烟尘颗粒物或气态污染物为目标污染物测试得出

产品：飞利浦二合一空气净化加湿一体机 AC4926  
型号：KJ400F-D02  
额定电压：220V ~  
额定频率：50Hz  
额定输入功率：73 W  
生产日期：请见产品本体  
产地：中国广东佛山



飞利浦（中国）投资有限公司  
上海市静安区灵石路 718 号 A1 幢  
全国顾客服务热线：4008 800 008

本产品根据国标 GB4706.1-2005，  
GB4706.45-2008，GB4706.48-2009 制造

## 产品性能指标

目标污染物	洁净空气量(CADR)	累计净化量(CCM)	净化能效等级
颗粒物	410 m <sup>3</sup> /h	P4	高效级
甲醛	200 m <sup>3</sup> /h	F4	高效级
甲苯	100 m <sup>3</sup> /h	-	高效级
噪声(声功率级)	65 dB (A)	适用面积*	29 - 49 m <sup>2</sup>

\*适用面积是按照国标GB/T18801-2015根据颗粒物洁净空气量计算得出  
以上性能指标数据是在第三方试验室按照国标GB/T18801-2015，以特定的  
烟尘颗粒物或气态污染物为目标污染物测试得出



© 2018 Koninklijke Philips N.V.

保留所有权利

4241 210 95634

